

## LADDER SHELF

ITEM CODE: G-0106

### ASSEMBLY INSTRUCTION

**0.5hr**

APPROXIMATE ASSEMBLY TIME

1 PEOPLE ASSEMBLY



FLOOR AREA  
1MX1M



REQUIRED ASSEMBLY SPACE

#### REQUIRED ASSEMBLY TOOLS

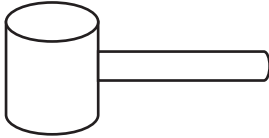

SOFT RUBBER HAMMER (Not Provided)

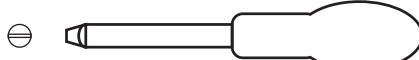

SLOTTED SCREWDRIVER (Not Provided)



POZI SCREWDRIVER (Not Provided)



MEASURING TAPE (Not Provided)

#### ASSEMBLED DIMENSIONS

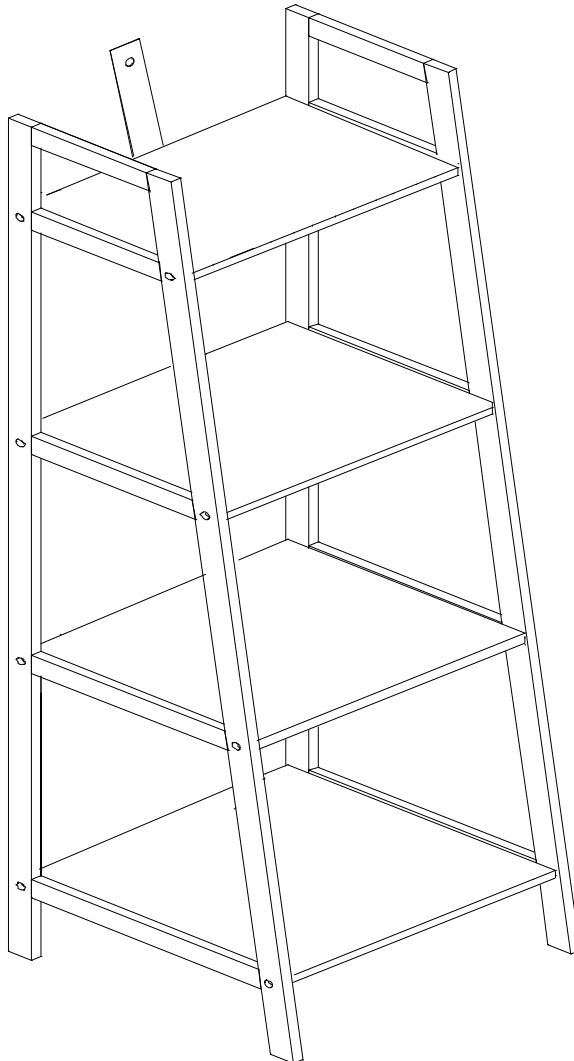

# LADDER SHELF

## ITEM CODE G-0106

### ASSEMBLY INSTRUCTION

#### PART LIST

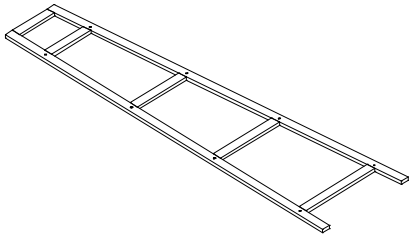

① X1pc

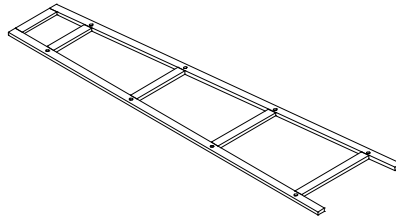

② X1pc

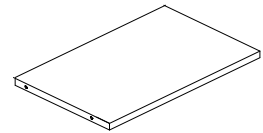

③ X 1pc

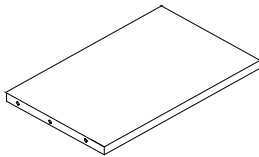

④ X1pc

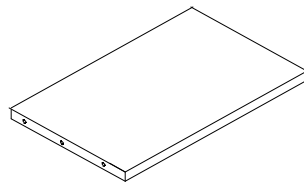

⑤ X1pc

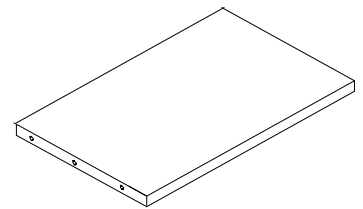

⑥ X 1pc



a X6pcs



b X 16pcs



c X16pcs

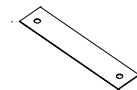

d X1pc



e X 1pc

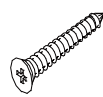

f X 1pc



g X 1pc

# LADDER SHELF

## ITEM CODE G-0106

### ASSEMBLY INSTRUCTION

#### STEP 1

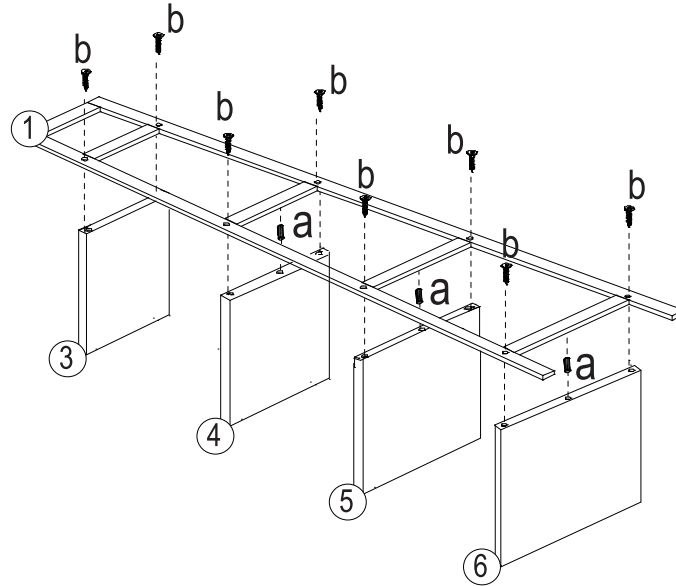

#### STEP 2

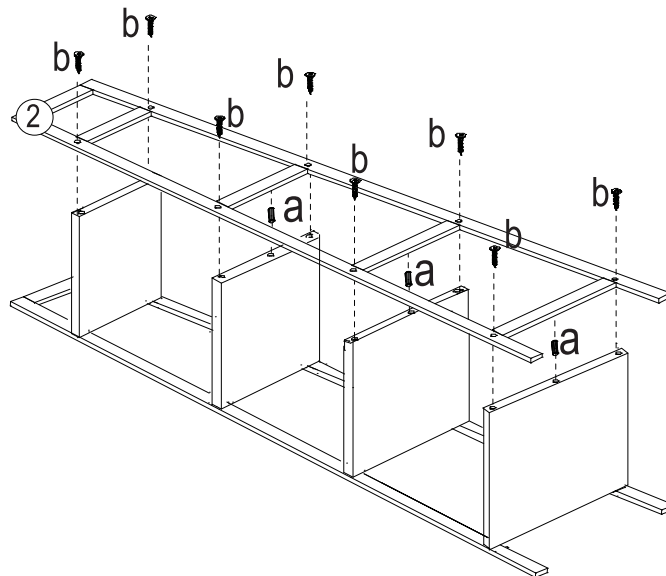

# LADDER SHELF

## ITEM CODE G-0106

### ASSEMBLY INSTRUCTION

#### STEP 3

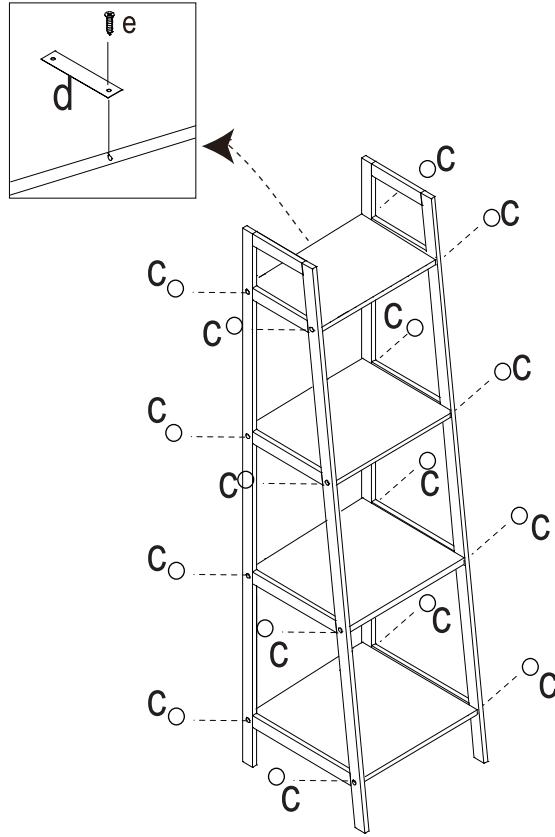

#### STEP 4

