

Assembly Instruction

60030

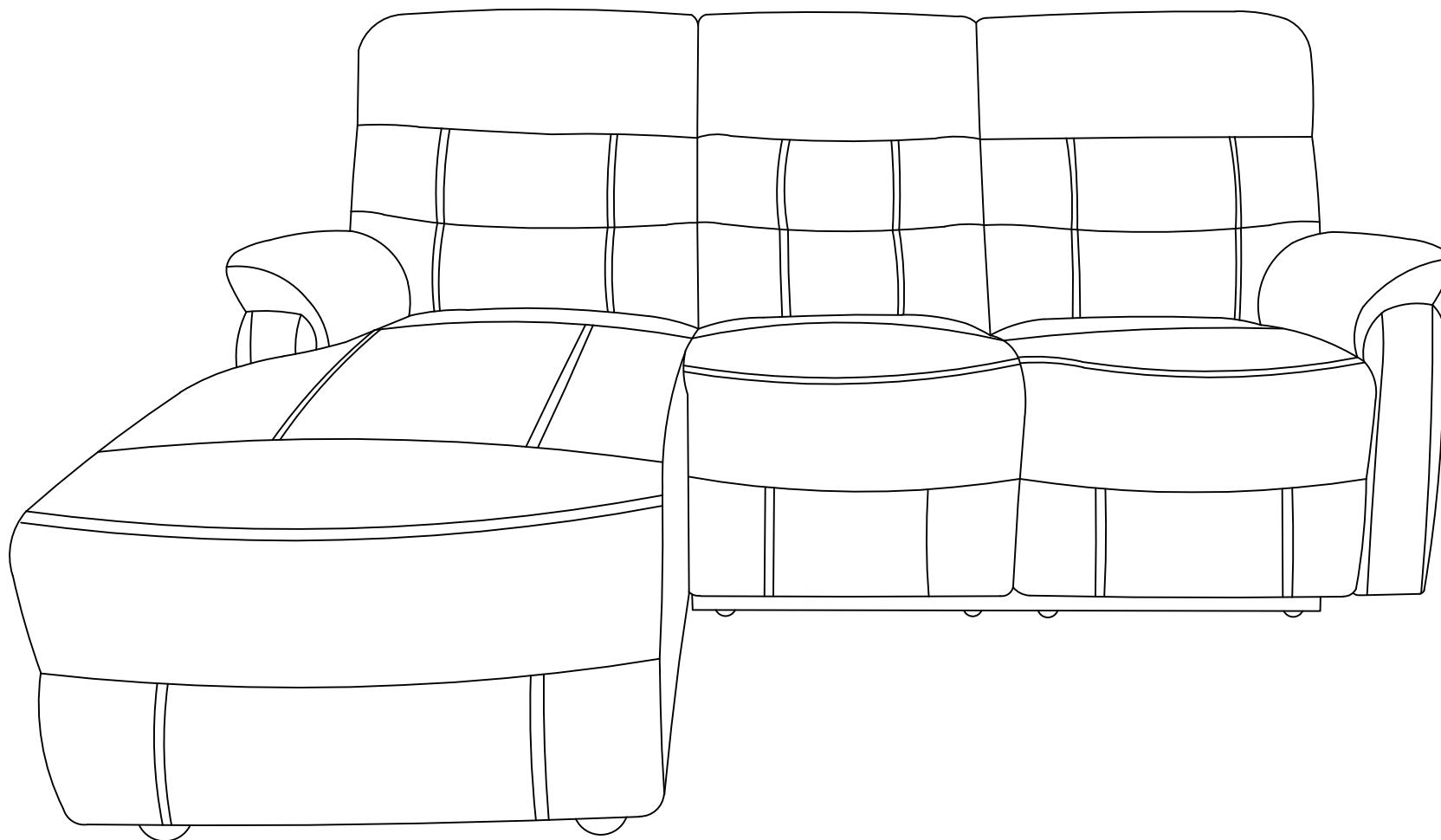

BOX 1/2:

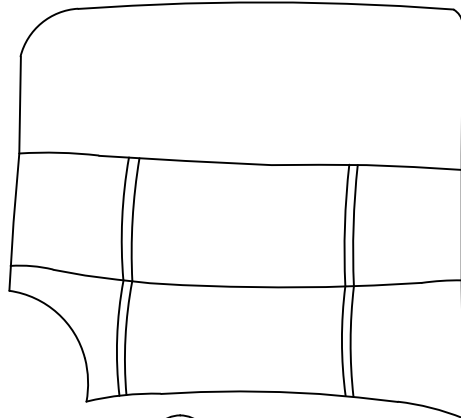

③ X1



⑦ X1

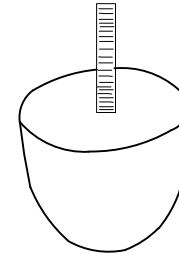

⑧ X6

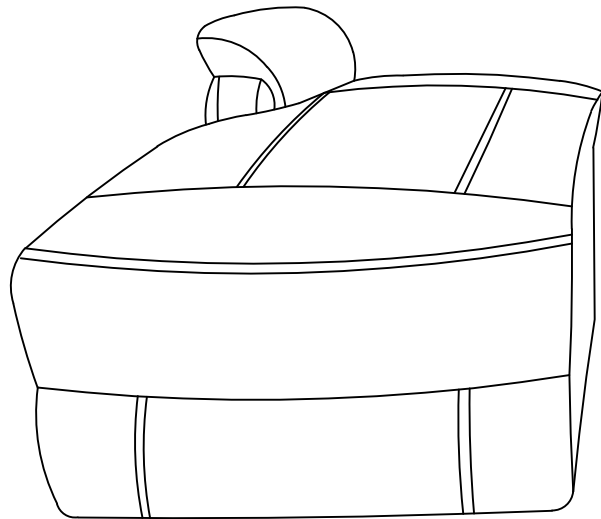

⑤ X1

Back cushion is put inside bottom of chaise

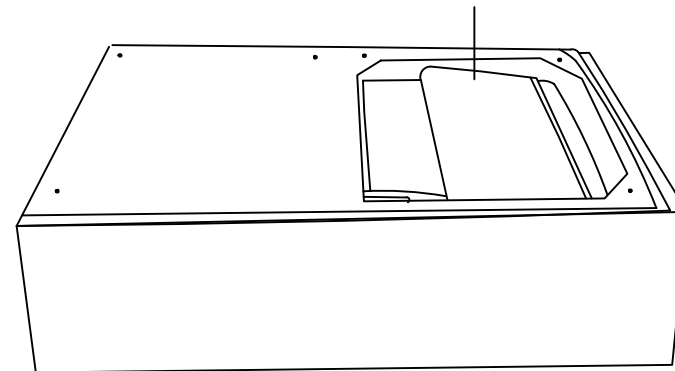

BOX 2/2:

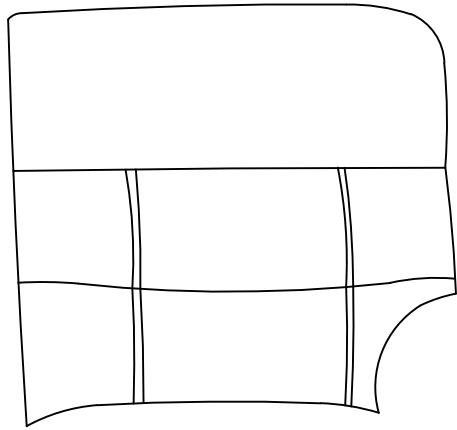

① X1

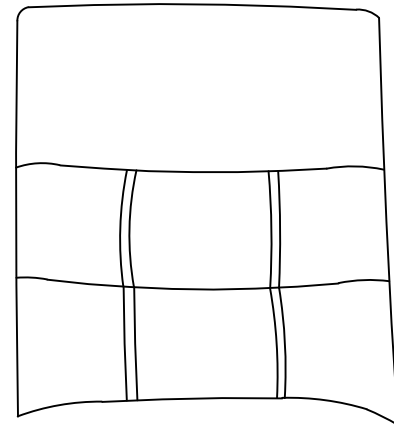

② X1

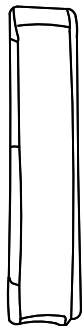

6 X①

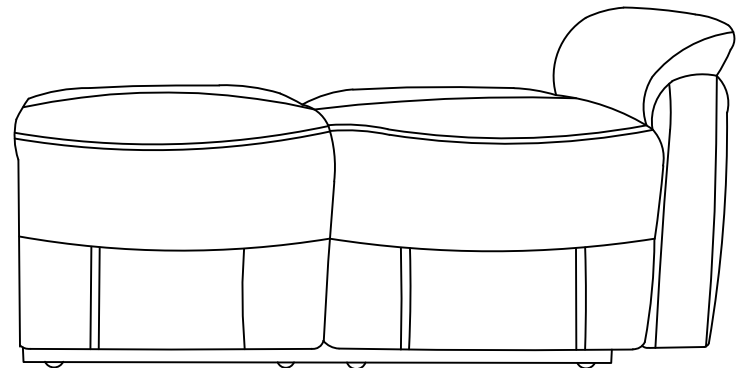

④ X1

Step 1: Assemble Chaise feet

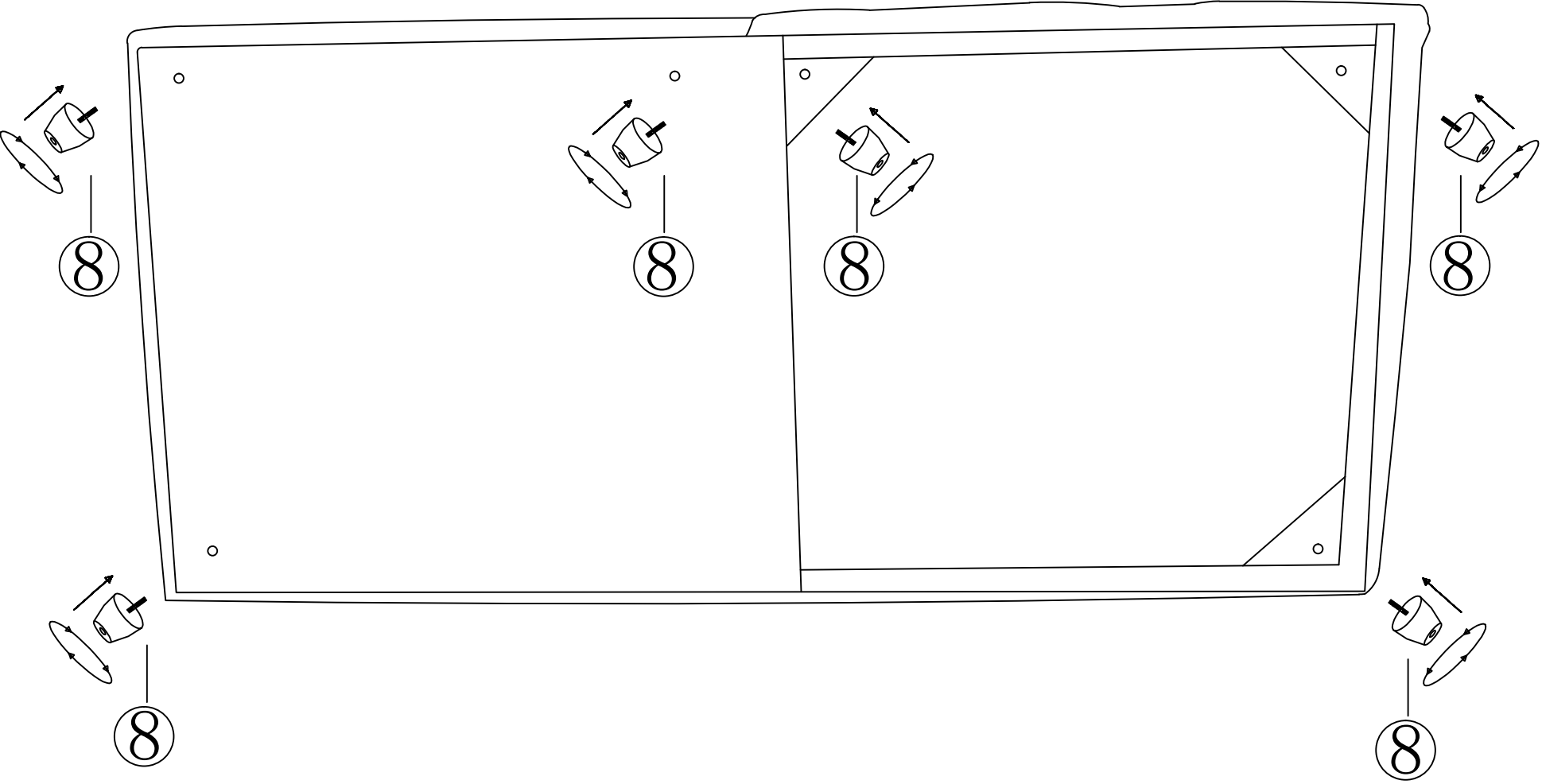

Step 2: Assemble backrest to seat

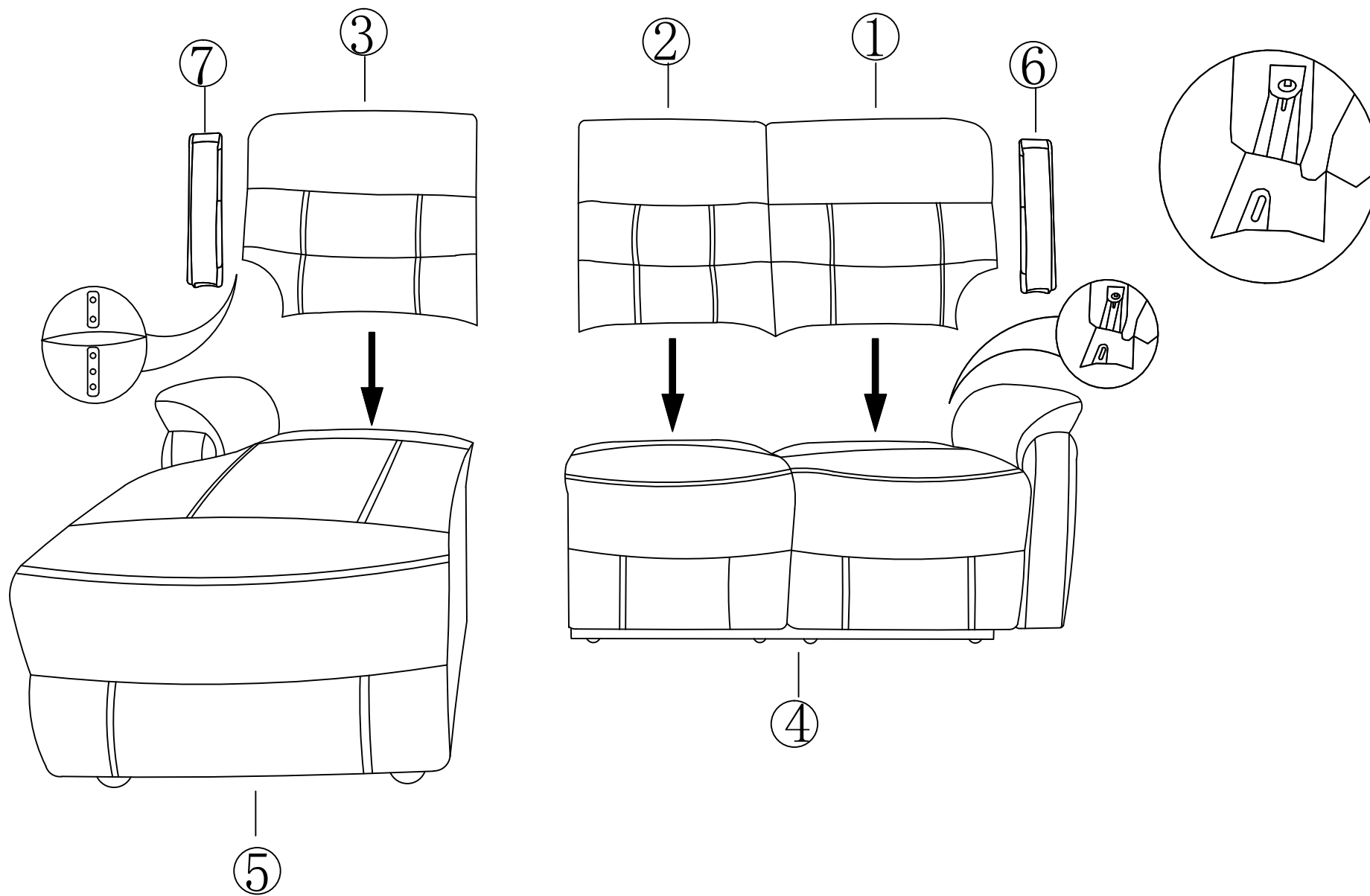

Step 3: Lock 2-seater sofa and Chaise

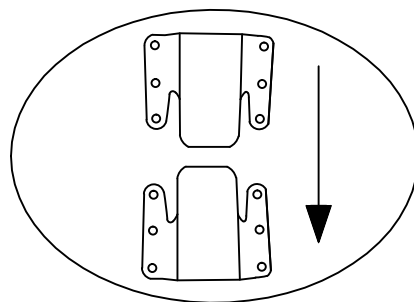
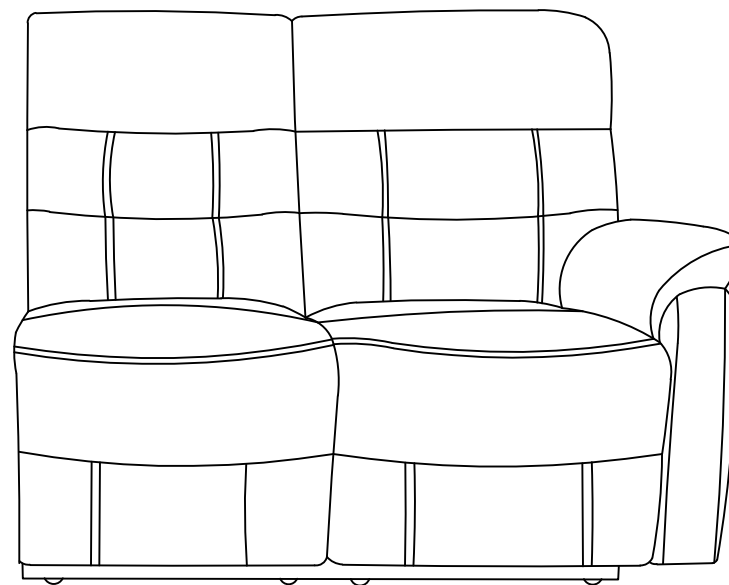
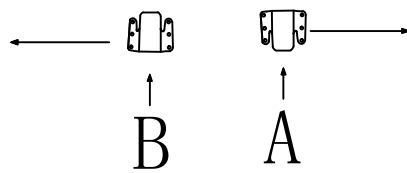
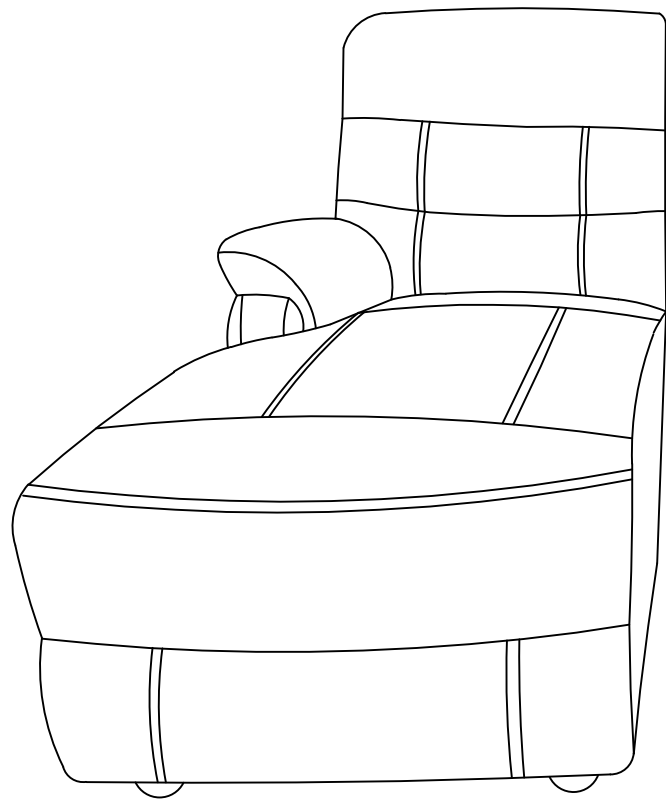

Step 4: Finish

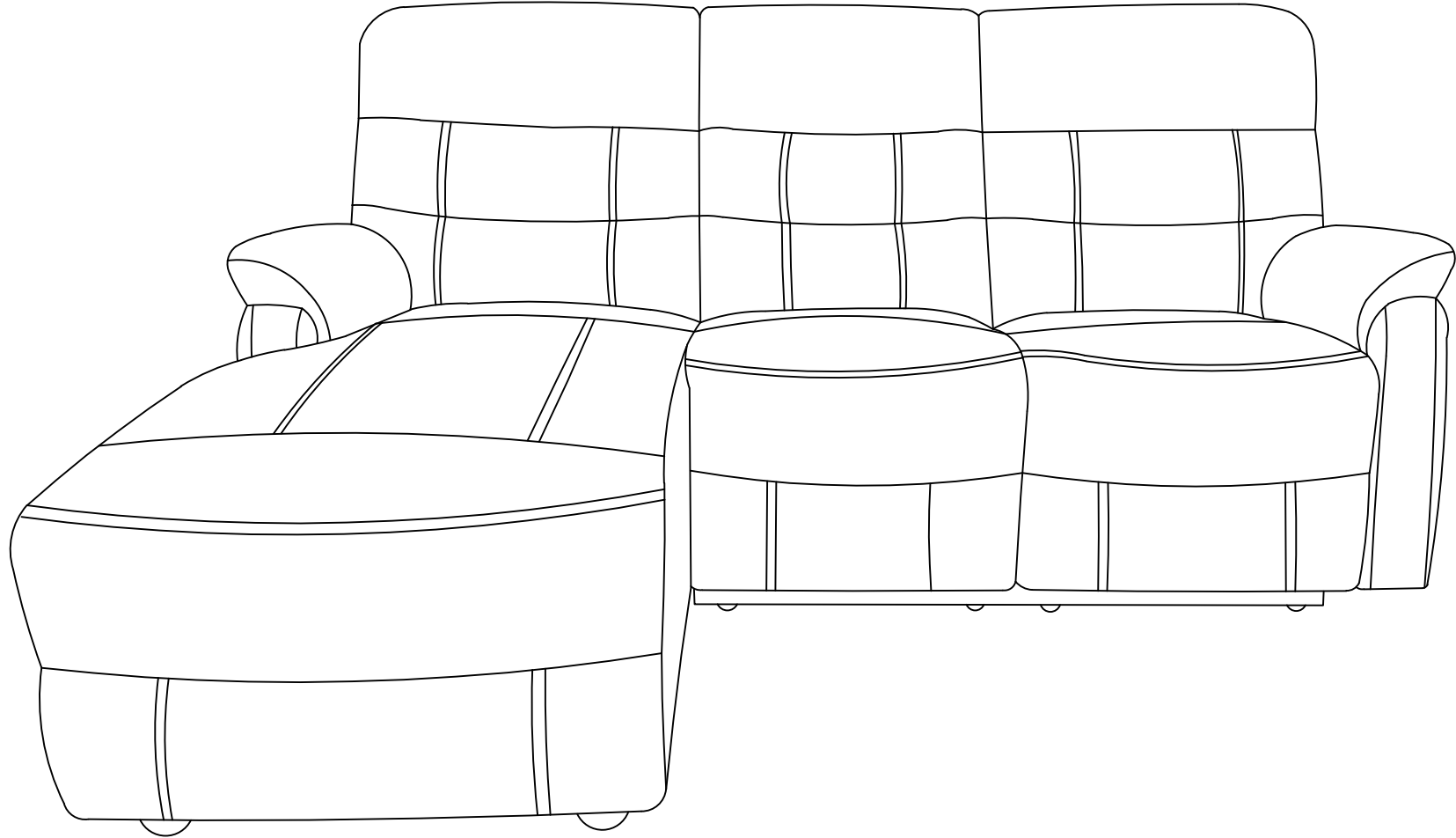

Step 5: Operate the recliner

