

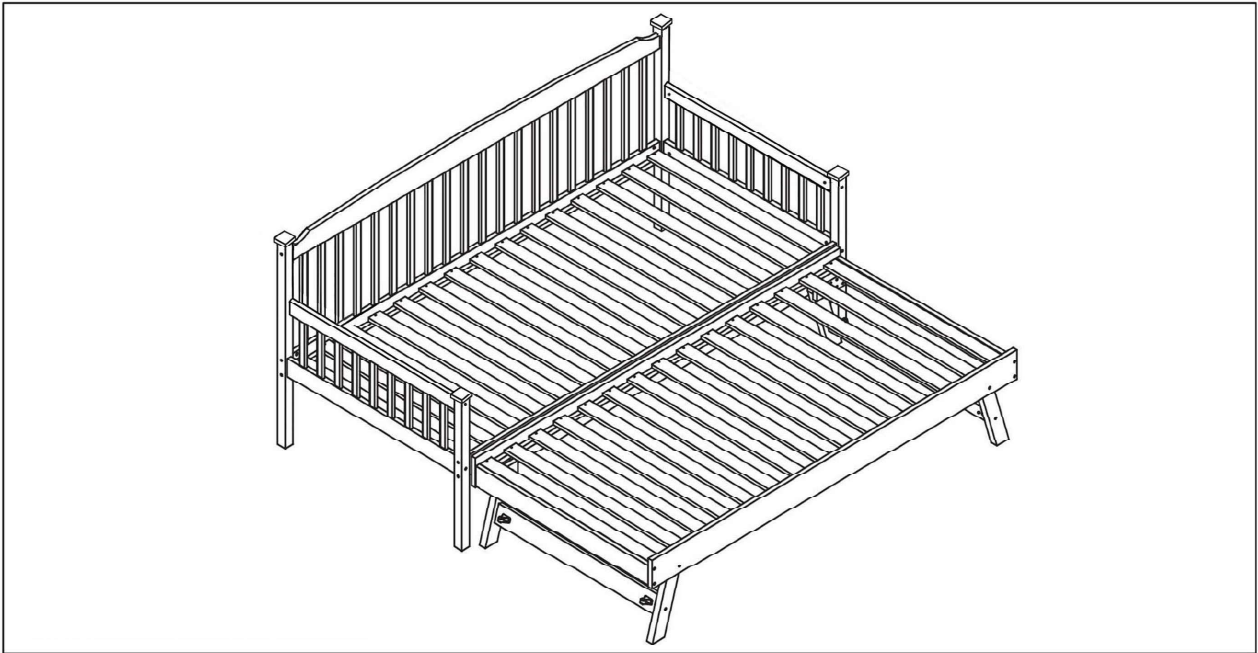









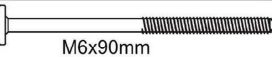



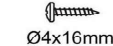

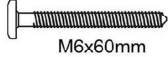

INSTRUCTION



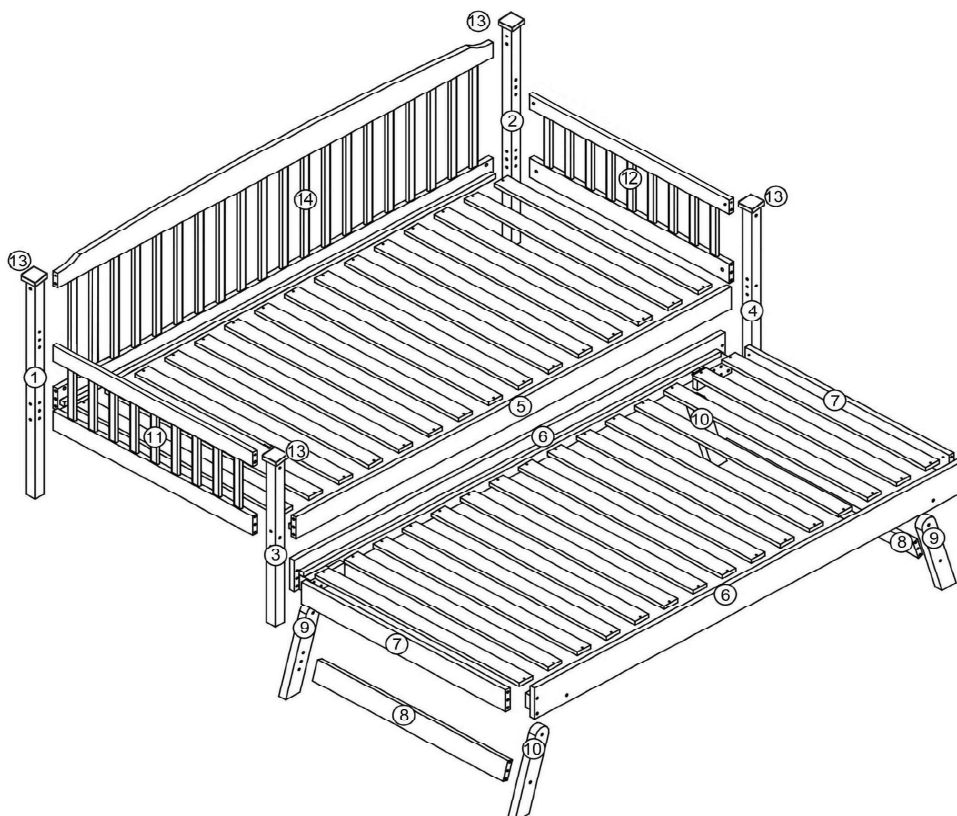

HARDWARE

A	 15mm  M6x90mm	18	G		04
B	 15mm  M6x70mm	12	H	 7mm  Ø4x16mm	08
C		30	I	 8mm  Ø4x30mm	60
D	 15mm  M6x60mm	04	J		02
E	 15mm  M8x20mm	06	K	 15mm  M6x30mm	02
F	 Ø8x30mm	36	L	 Ø8mm	22
			M		01



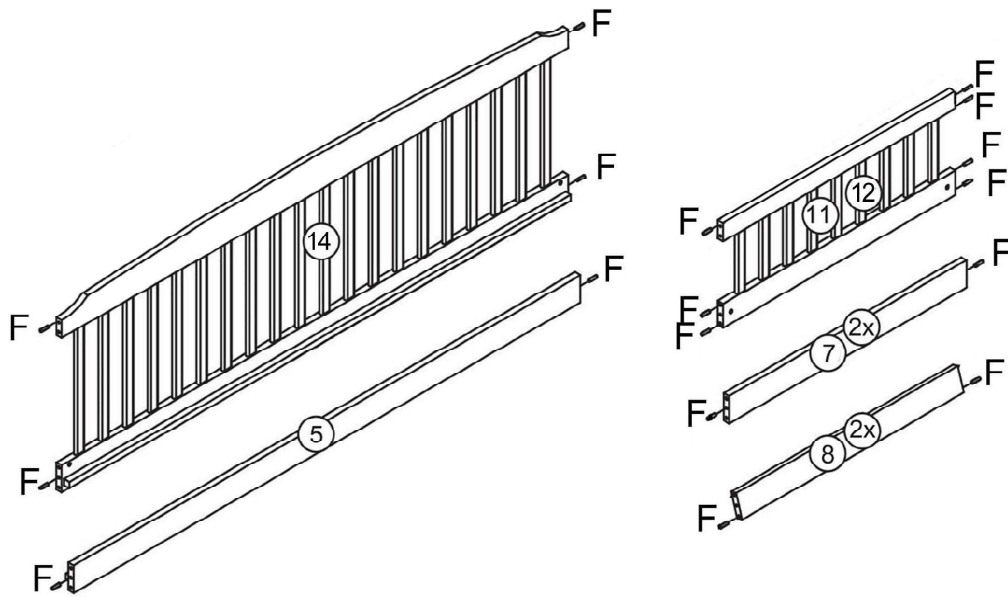

01



F	 Ø8x30mm	28
---	--	----

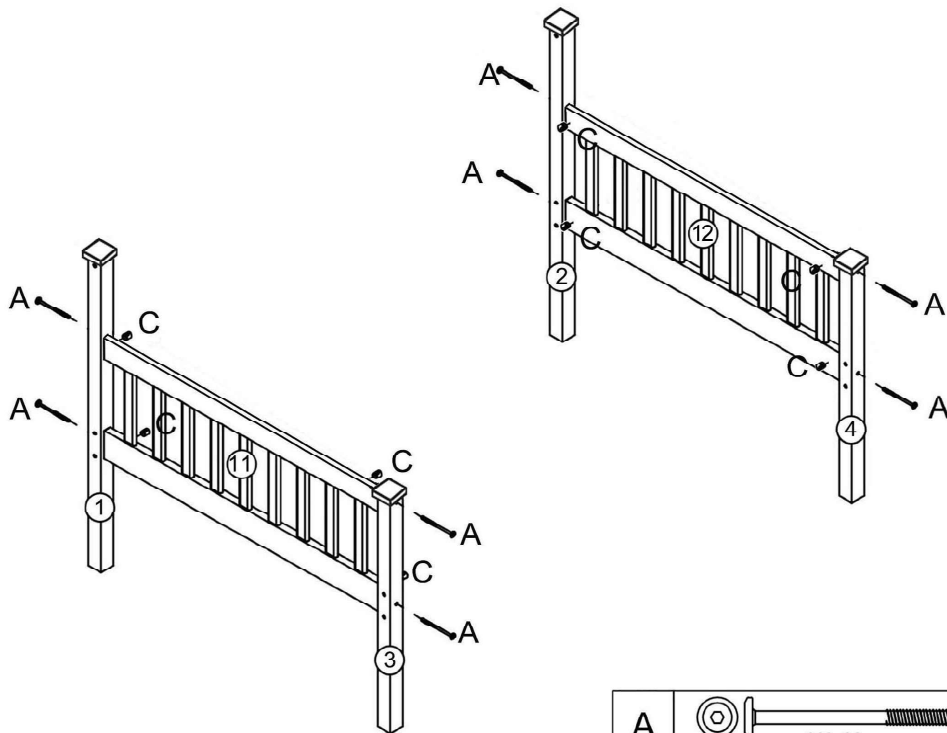

02

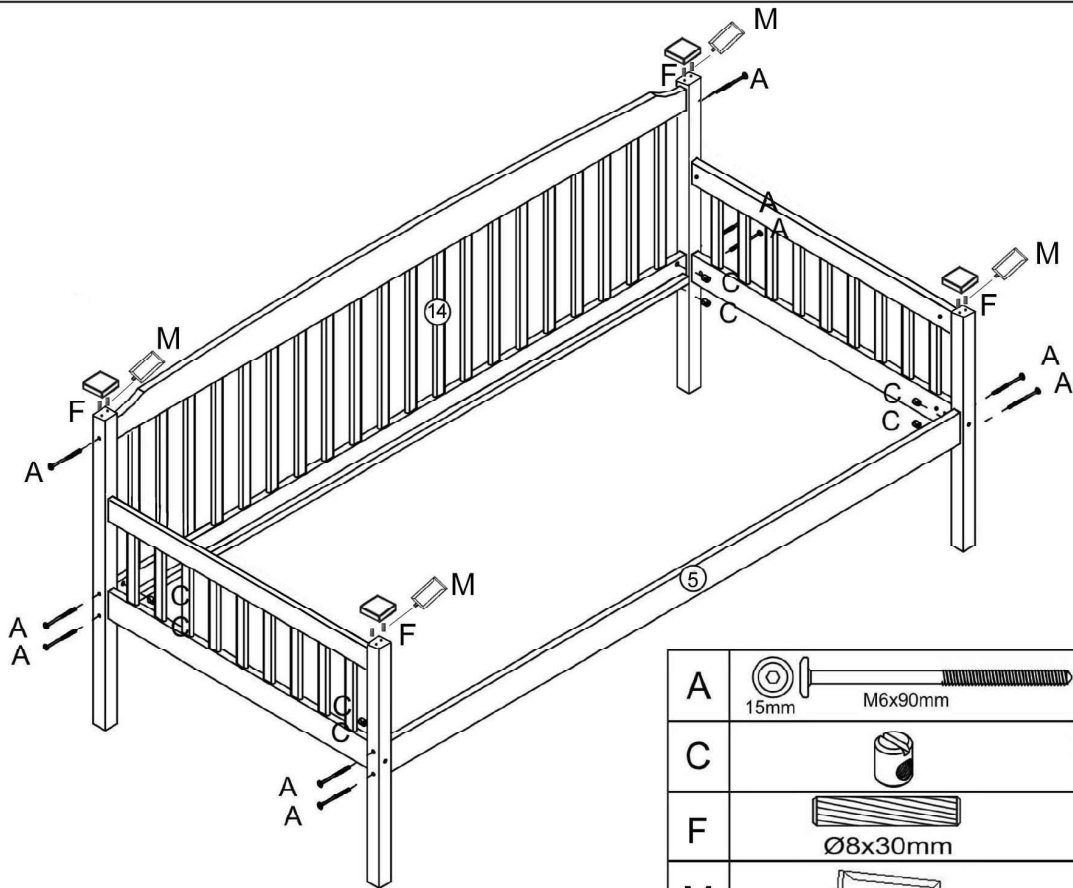

A	 15mm M6x90mm	08
C		08

03

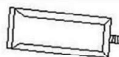

A	 M6x90mm 15mm	10
C		10
F	 Ø8x30mm	08
M		01

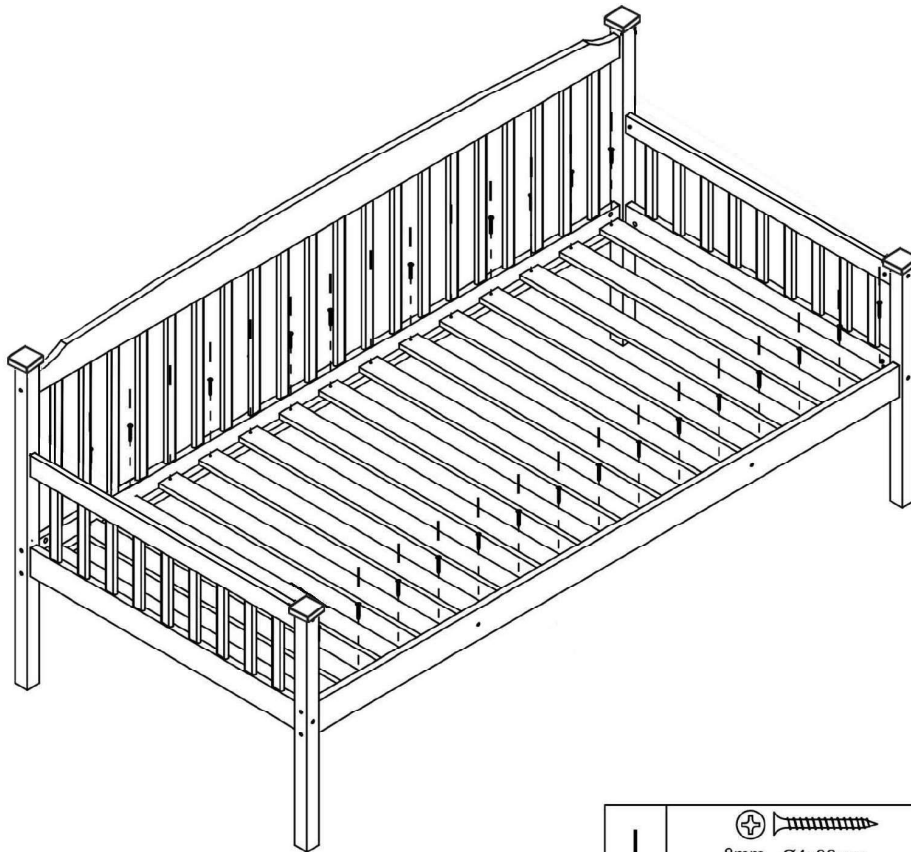

04

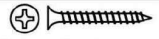

I	 8mm Ø4x30mm	30
---	--	----

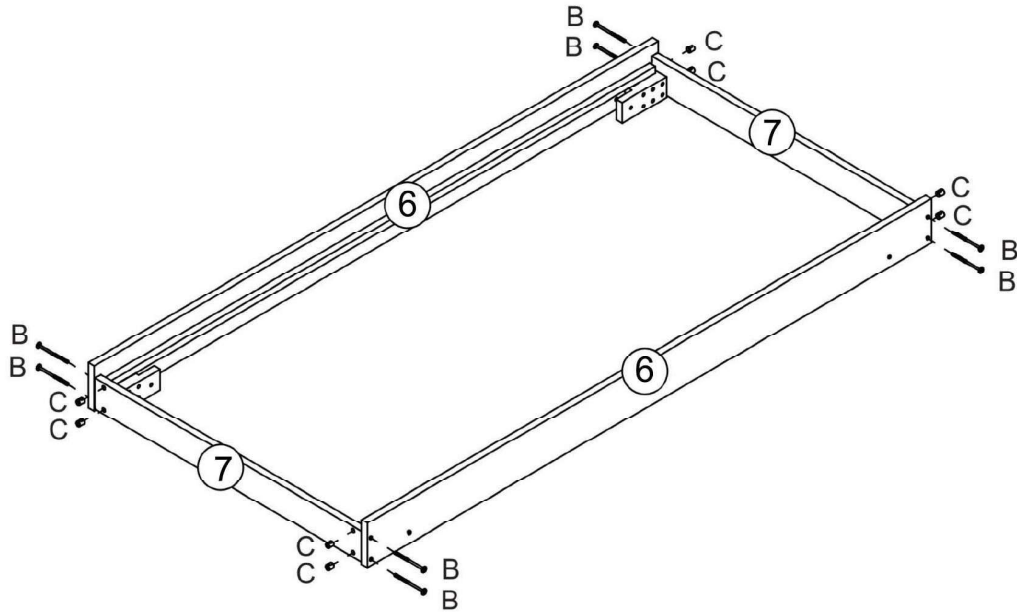

05



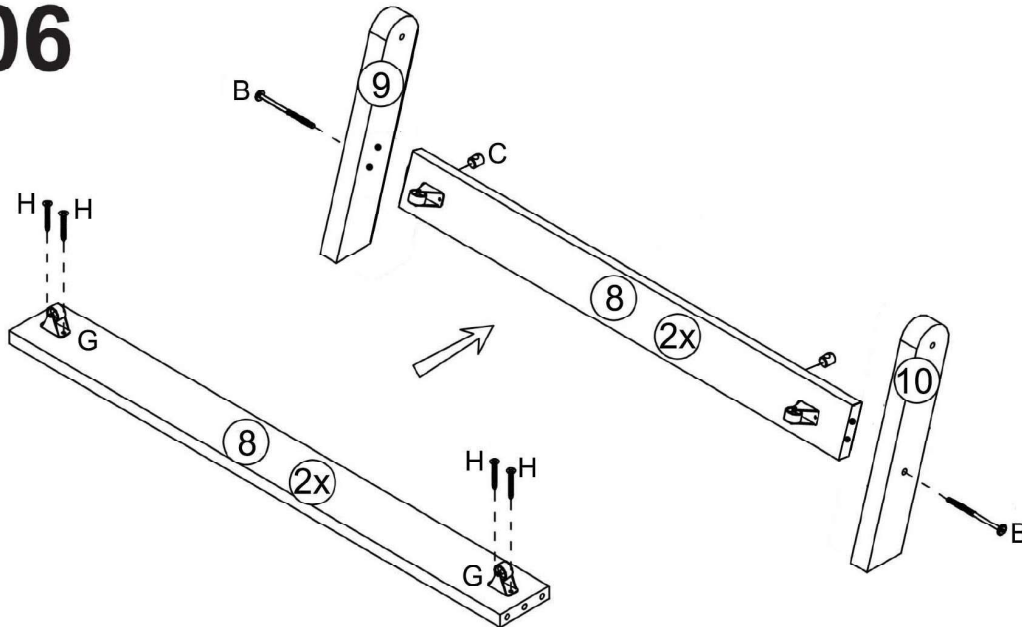

B	 15mm	 M6x70mm	08
C			08

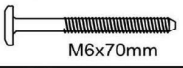
06





B	 15mm	 M6x70mm	04
C			04

G			04
H	 7mm	 Ø4x16mm	08

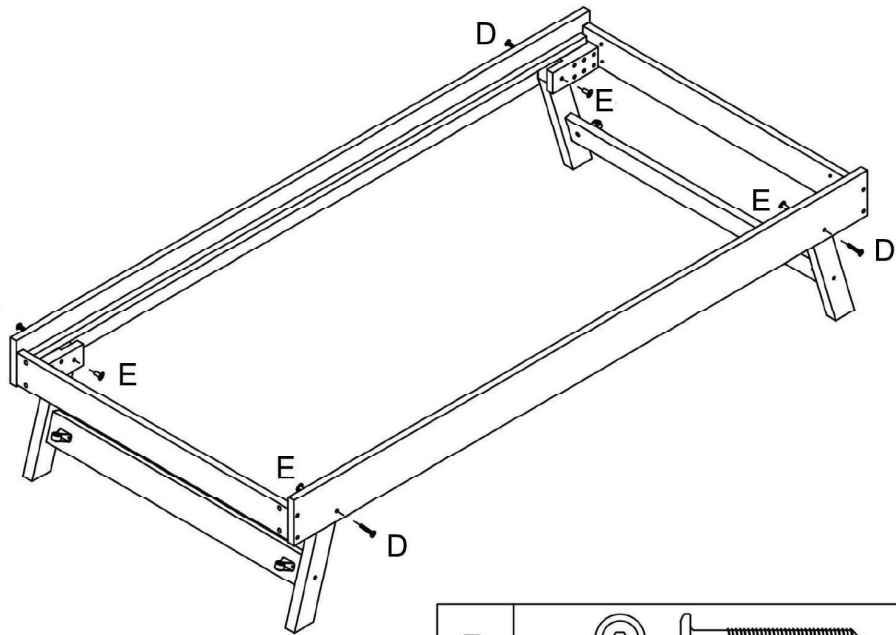

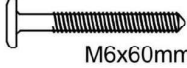
07



D	 15mm	 M6x60mm	04
E	 15mm	 M8x20mm	04

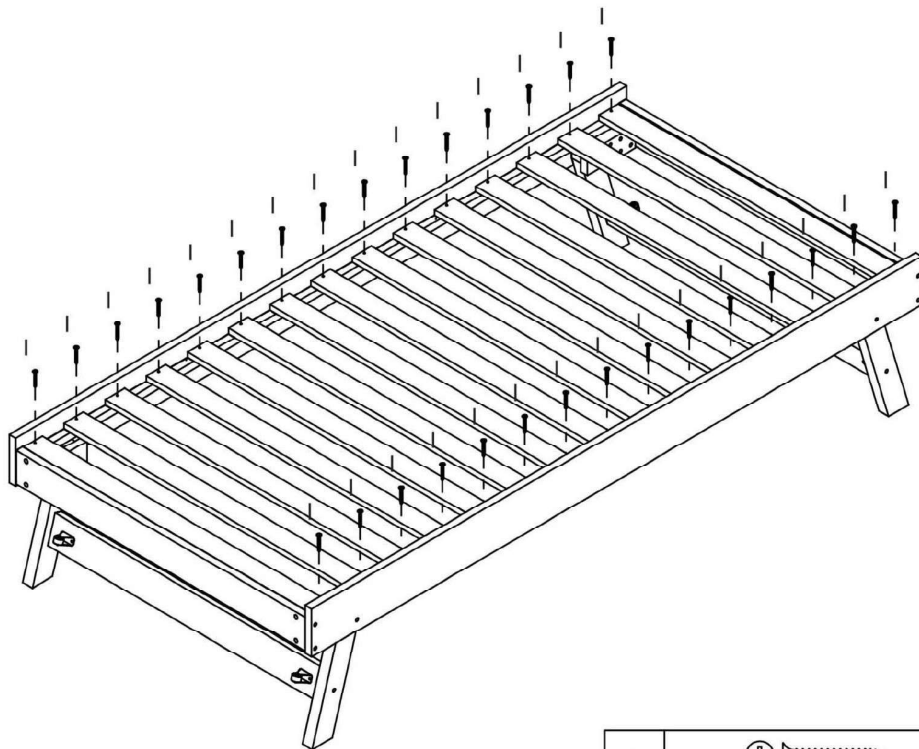

08

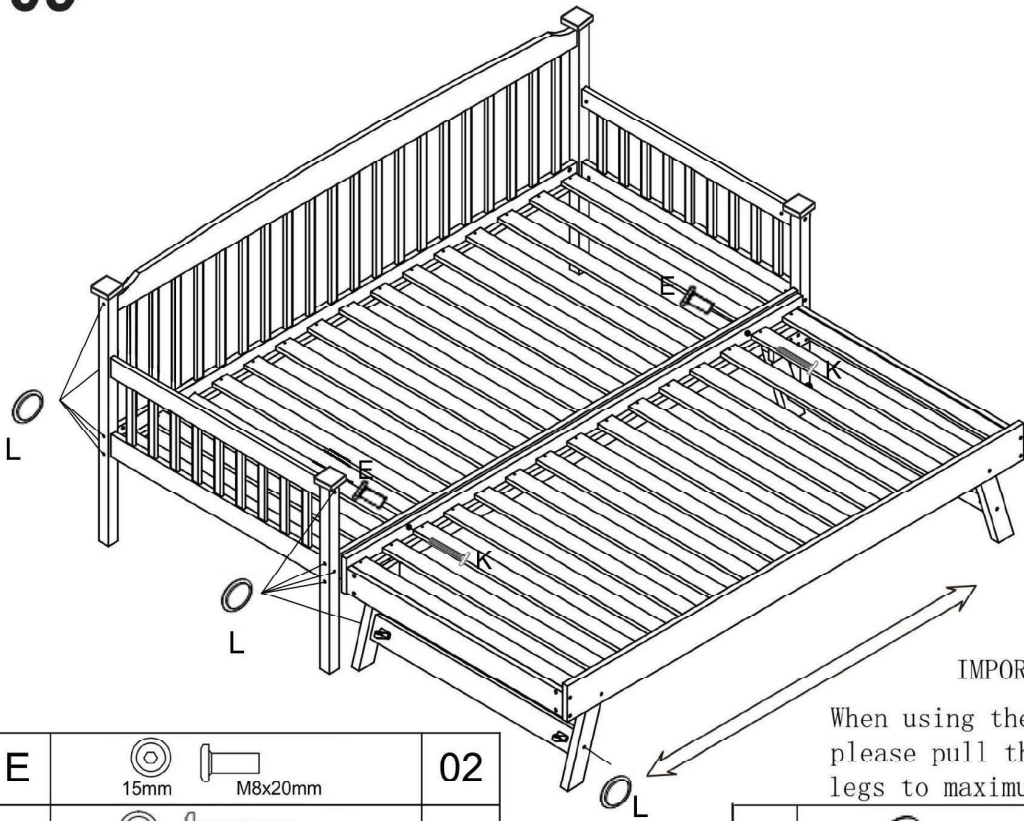

I	 8mm	 Ø4x30mm	30
---	--	--	----

09

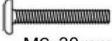

E	 	02
K	 	02

L	 Ø8mm	22
---	--	----

10

