

BERG

USER'S INSTRUCTION MANUAL



www.berginnovations.com

Far Infrared Glass Panel Heater

Model: BIR-720GB, BIR-600GB, BIR-480GB

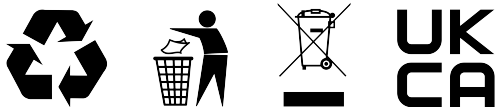

READ INSTRUCTIONS CAREFULLY: Read and follow all instructions. Store instructions in a safe place for future reference. Do not allow anyone who has not read these instructions to assemble, adjust or operate the heater.

IMPORTANT INSTRUCTIONS

PLEASE READ AND SAVE THESE IMPORTANT SAFETY INSTRUCTIONS

When using electrical appliances, basic precautions should always be followed to reduce the risk of fire, electric shock, and injury to persons, including the following:

1. Read all instructions before using this heater.
2. **Extreme caution:** This appliance is not intended for use by persons (including children) with reduced physical, sensory or mental capabilities, or lack of experience and knowledge, unless they have been given supervision or instruction concerning use of the appliance by a person responsible for their safety. Children should be supervised to ensure that they do not play with the appliance.
3. This heater is hot when in use. To avoid burns, do not let bare skin touch hot surfaces. Keep combustible materials, such as furniture, pillows, bedding, papers, clothes, and curtains at least 3 feet (0.9m) from the front of the heater and keep them away from the sides and rear.
4. Do not operate the heater with a damaged cord or plug or after the heater malfunctions, has been dropped or damaged in any manner. Return it to authorized service facility for examination, electrical or mechanical adjustment, or repair.
5. The heater is designed for indoor use.
6. The heater can be wall mounted or free standing. Do not mount on ceiling.
7. This heater can be used in bathrooms, laundry areas and similar indoor locations in accordance with IP44 rating. Never locate heater where it may fall into bathtub or other water container.
8. Do not cover cord with throw rugs, runners, or similar coverings.
9. To prevent a possible fire, do not block the space between the heater and the wall.
10. Do not use it in the areas where gasoline, paint, or flammable liquids are used or stored.
11. Use this heater only as described in this manual. Any other use not recommended by the manufacturer may cause fire, electric shock, or injury to persons.
12. Avoid the use of an extension cord because the extension cord may overheat and cause a risk of fire. However, if you have to use an extension cord, the cord shall be rated not less than 800 watts (under 220-240V).
13. Do not install the heater directly under an electric wall socket.
14. It is normal for the plug to feel warm to the touch; however, a loose fit between the AC outlet (receptacle) and plug may cause overheating and distortion of the plug. Contact a qualified electrician to replace loose or worn outlet.
15. The output of this heater may vary and its temperature may become intense enough to burn exposed skin. Use of this heater is not recommended for persons with reduced sensitivity to heat or an inability to react to avoid burns.
16. **WARNING: In order to avoid overheating, do not cover the heater.**
17. **“SAVE THESE INSTRUCTIONS”**

UNPACKING AND WALL MOUNTING INSTRUCTIONS

Unpack your package and find the heater together with the wall mounting accessories pack.

1. Mark the positions of the four holes to be drilled on the wall. Make sure the distance between the holes exactly match up with the holes on the brackets at back of the heater.
2. Drill the holes with an appropriate sized drill bit.
3. Insert the plastic rawlplugs into the holes.
4. Insert the metal screws into the rawlplugs.
5. Lift the heater and aim the four holes on the brackets at back of the heater to the 4 screws on the wall, and slide the screw from Position A to Position B by moving the heater slightly.
6. Make sure the distance between the bottom of the heater and the floor is no less than 20cm when the heater is installed

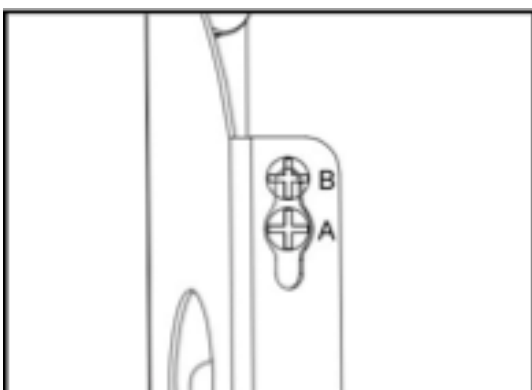
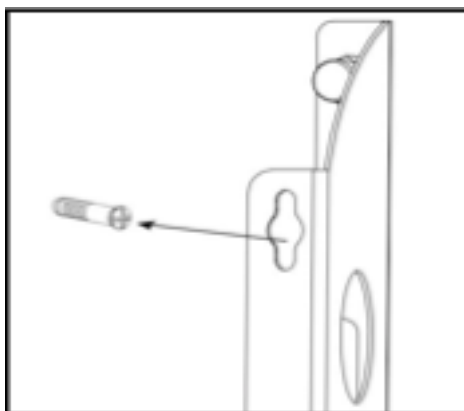
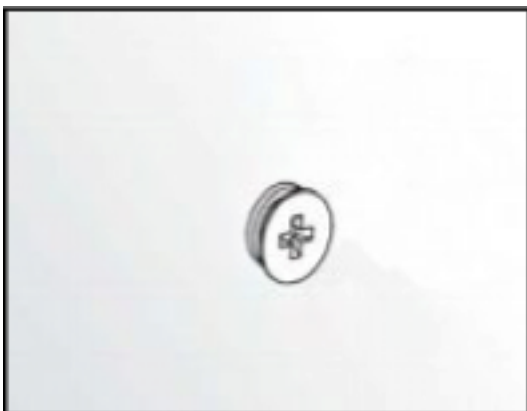
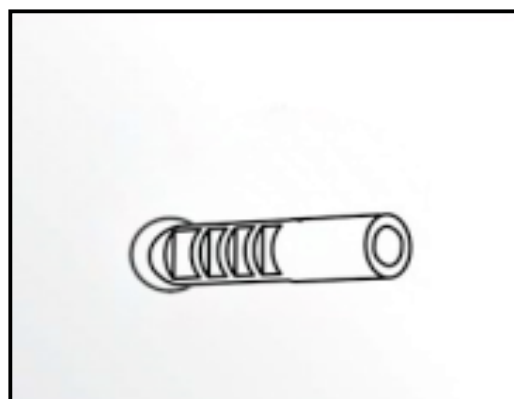
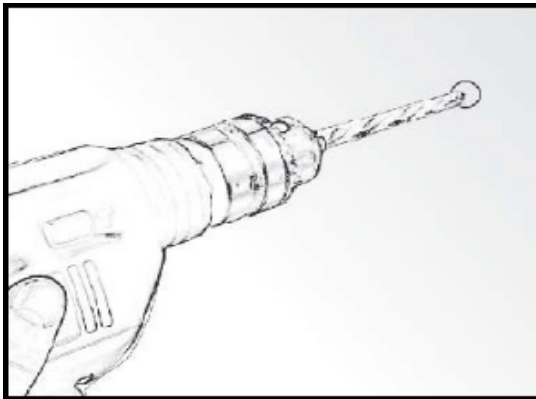

FREE STANDING INSTRUCTIONS

1. Position the feet into the grooves of the bracket on the bottom, ensuring to cover the cap nuts on the back of the heater. Make sure the feet are the right way around then use the supplied screws to fix into position.

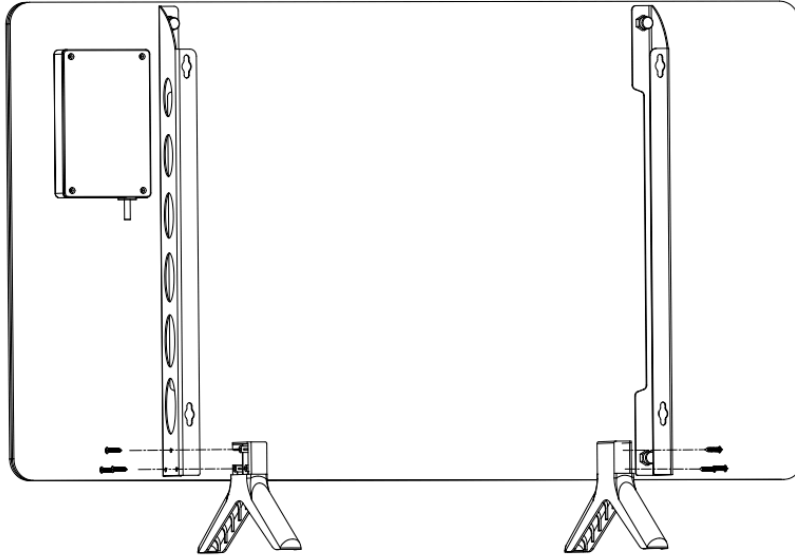

DISPLAY & CONTROL PANEL

Operating Menu

1. ON/OFF
2. Temp./Timer DOWN key,
Long press (2s) to turn OFF the “Child Lock”
3. Temp./Timer UP key,
Long press (2s) to turn ON the “Child Lock”
4. Setting Key

Display Part

5. Child Lock indicator
6. Timer
7. Heating indicator light
8. Wi-Fi indicator light
9. Celsius Degree indicator light
10. Timer indicator light
11. ECO mode indicator light
12. Display of temperature/timer

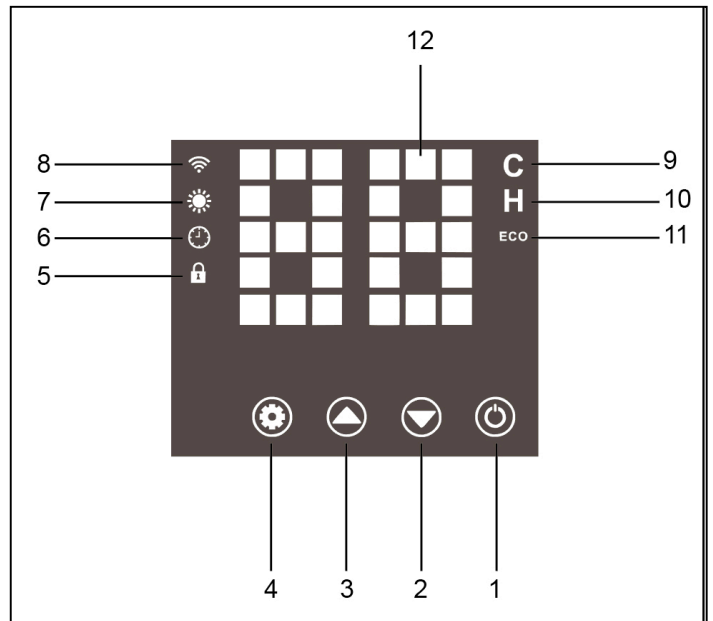

Instructions of the indicator light:



ON/OFF: Press to turn on /turn off the heater;



Setting Key: Press Setting key to cycle the setting between temperature and timer, when the **H** icon is lit, the timer can be set; when **C** icon is lit, the temperature can be set.

Long press to turn on / turn off Wi-Fi mode.



Wi-Fi indicator light. There are 3 modes for this light:

1. Solid light on: means Wi-Fi is connected; you can operate the heater by Tuya APP with your smartphone;
2. Rapid blink: you can connect the heater to Wi-Fi by smartphone; majority of devices will connect to the Wi-Fi on this mode;
3. Slow blink: you can connect the heater to Wi-Fi by smartphone, few devices will connect to the Wi-Fi on this mode.

You can long press the setting key to alternate between rapid blink and slow blink.



Heating indicator light: Indicates the unit is in actively heating when lit.

Remote Control Instructions

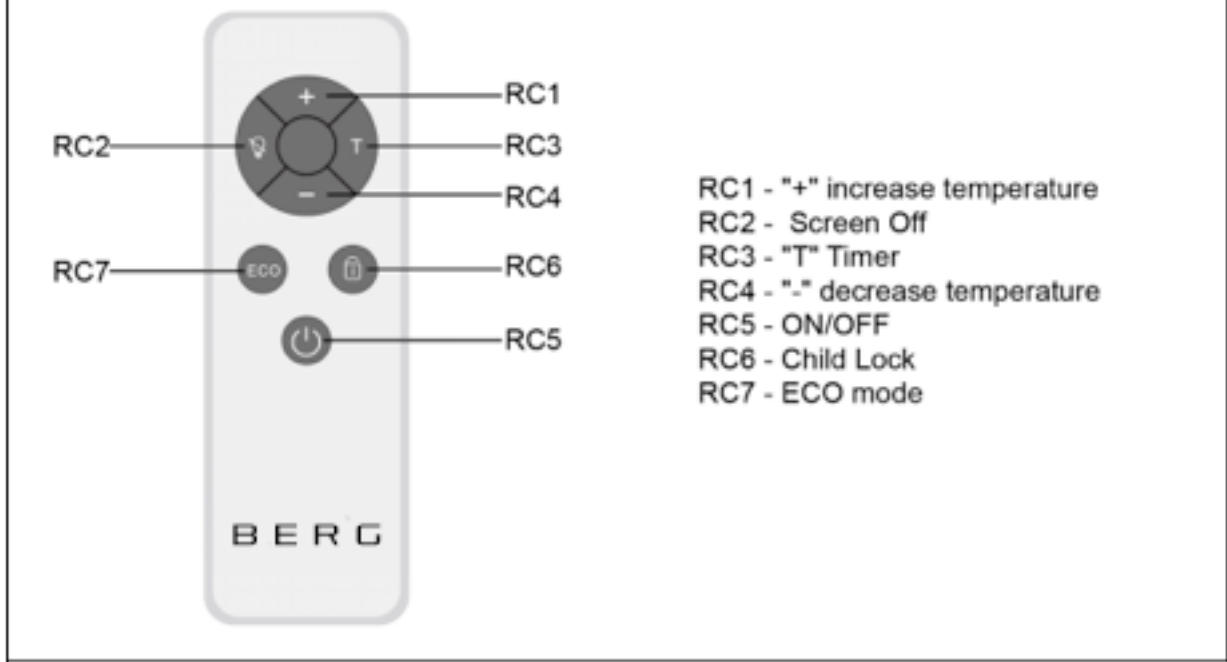

NOTE : Before using the remote control, make sure that 2 x AAA battery are installed correctly.

Instruction of Remote control :



RC2: Press to turn heater display screen off, press again to turn on.



RC6: Press to lock, the icon of  will be lit, then all the keys on the control panel or on the remote control will be unavailable (except display on/off key); press again to unlock.



RC7: Press to turn on the ECO mode,  will be lit; when the room temperature drops more than 5 degrees in 1 minute, the heater will automatically stop heating to save energy.



This is most likely to occur if a window is opened and left open.

Then you need to restart the heater to turn on the unit.

OPERATING INSTRUCTIONS

There are 2 modes to use this heater

I. Manual / Remote Control Heating ON/OFF mode with 24 hours timer

1. Check the heater to be sure it is not damaged before using.
2. Insert the plug in the socket;
3. Turn the main switch on, you will hear “beep”, the big display screen will be lit, then display “--”, Wi-Fi light flashing and the heater is in standby mode;
4. Press “ON/OFF” key, the display screen will show the room temperature. The default setting temperature is 25°C, the unit will start heating when the room temperature is lower than 25°C, the heating icon will be lit; the unit will only show room temperature without heating when the room temperature is higher than 25°C.
5. Press the “up” or “down” key to adjust the temperature setting, it will flash for 5 seconds on the display to confirm the setting temperature, then revert back to room temperature display. With each key press, the temperature will be increased (+) or decreased (-) by one degree.
6. Heater will start working when the setting temperature is 1 degree higher than room temperature, or stop working when the setting temperature is 1 degree lower than room temperature.
7. Press  until the **H** is light on to set the 0-24 hours timer, with each press of  to increase one hour and with each press of  to decrease one hour, it will be cycle as

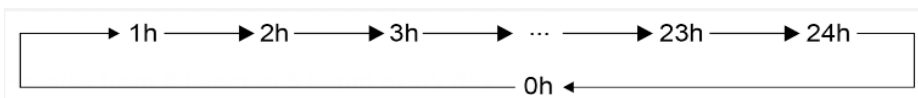

The countdown timer is set after 5 seconds unchanged blinking, then display room temperature. The heater will automatically turn OFF after the timer duration is complete.

II. Tuya App Control for Weekly Program mode 7*24hours / Operating over Wi-Fi

(Connect Wi-Fi and APP to operate with smartphone)

The Tuya app is regularly updated, so the below instructions and functions may vary slightly in practice.

1. Connecting to Wi-Fi
 - i. To connect your heater to the Wi-Fi, the first step is to download the TUYA Smart app onto your smartphone. You can find the app by scanning the QR code below or searching “TUYA Smart” in the Google Play or Apple App Store.



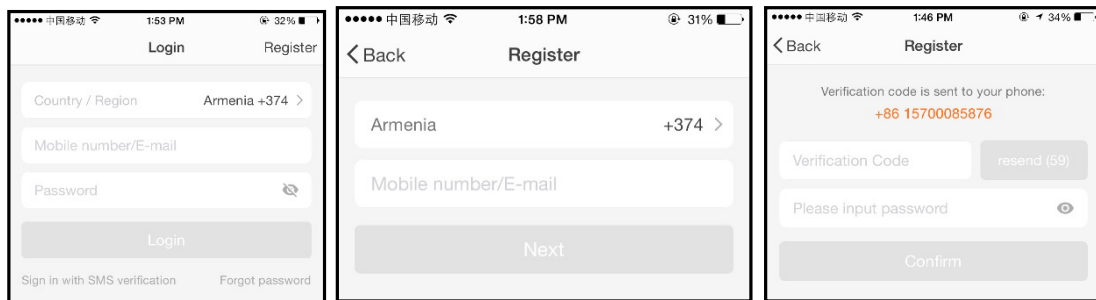

ii. Download and install the app. Unless you already have a Smart Life account, you will need to create an account by tapping Register.





iii. The device will automatically determine your country, although you can change this if necessary. Enter your phone number or email address. A verification number will be sent to your phone / email: enter this number to verify, then create a password.

iv. To add your heater to the app, first put the heater in Wi-Fi connection mode. Turn the main switch on, you will hear “beep”, the full screen will be lit for 1.5 seconds, then display “--”, Wi-Fi light  flashing and the heater is in standby mode; You can connect Wi-Fi and add the device in TUYA APP with smartphone.

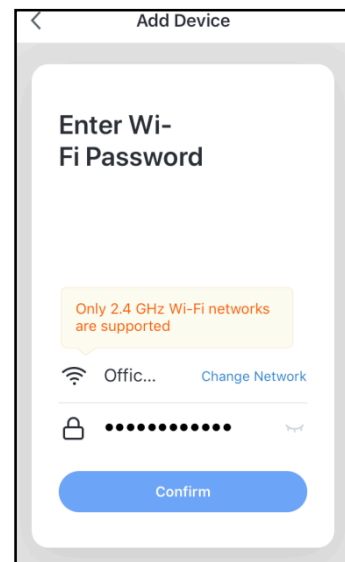
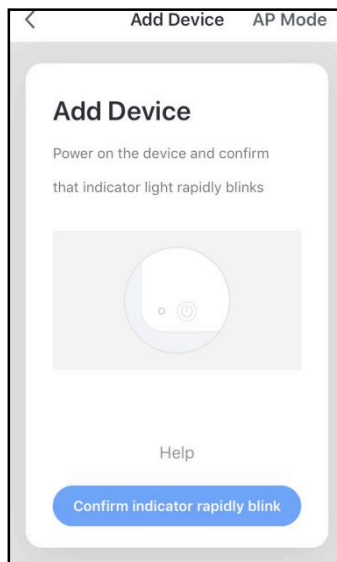
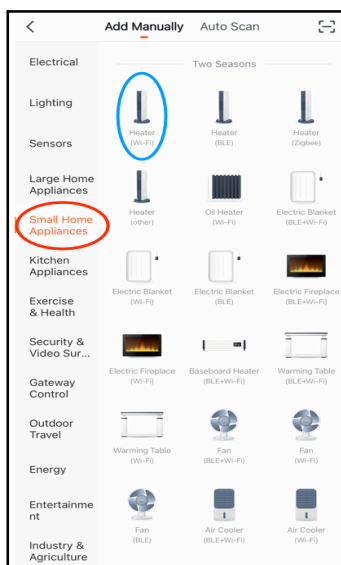
v. If the Wi-Fi icon is not flashing, press the “on/off” button  back to the standby mode. Once the icon  is flashing, go to the app and press Add Device. Select the device type (Small Appliances > Heater (Wi-Fi)) and confirm that the indicator is flashing. You will then be prompted to enter your Wi-Fi password. This allows the app to find your heater using your Wi-Fi.



You will then be asked to “Confirm the indicator is blinking”; this refers to the blinking Wi-Fi indicator on the heater. Go ahead and confirm this and follow the instructions in the app or if not then go back to step (v.). If you have trouble connecting please refer to the note below.

NOTE: if the heater is failing to connect, long press  for 5 seconds. The heater will then switch to its secondary connection mode. The heater has two connection modes: one where the Wi-Fi icon  flashes slowly (once per second) and one where the Wi-Fi icon  flashes fast (three times per second). Most devices will connect on the fast flashing mode.

vi. The app will confirm that the heater has been added. You can now edit the name of the device so that it is clear to you which heater it is. Useful if you have multiple heaters.

vii. There are also further advance options within the Tuya app, which allow you to share device, set up groups and much more.

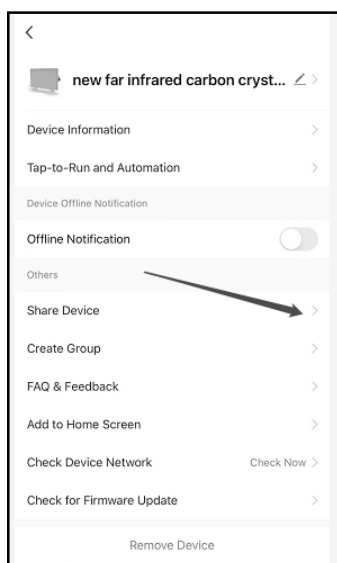
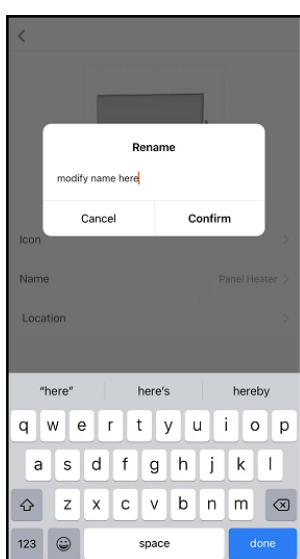

2. Using the SmartLife /Tuya App.

i. You can use the app to control multiple devices. The status of your devices is shown on the device list:

Offline (device can not operate by smartphone)

Turned Off (device is in standby mode)

Turned On (device is in heating mode)

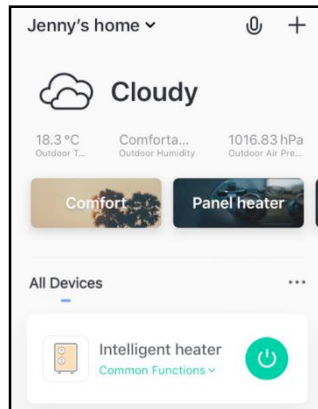

ii. When the heater is online, tap the device name to go to the control interface. Note: when the heater is offline, you will not be able to control it with the app.

iii. Using the Wi-Fi and App to control the heater.

A - Switch: Turn On/Off the heater.

B - Countdown: Set 0-24 hours timer to turn off the heater.

Functions C-F below will be found in Settings:

C - Child Lock: Turn On/Off Child Lock,  on the heater will be lit when on.

D – ECO (Open Window Mode) mode: Turn On/Off Eco mode, the  icon will be lit when on. When the room temperature drops 5 degrees in 1 minute, the heater automatically stops heating to save energy.

E - 7*24 hours heating schedule: you can choose time, day, target temperature, turn on/off the heater.

F - For every event, you must set a start time. Then, choose whether you want it to repeat. Select “Only Once” if you just want to set a timer for now. If you want the event to repeat, select which days you want it to occur. Then, choose whether you want the heater to switch on or off. Finally, choose the target temperature to turn on the heater. Make sure you confirm your settings at every stage and press save to keep the event. Each event will appear in your schedule. You can activate and de-activate events using the toggle. You can also delete events by swiping left and tapping Delete.

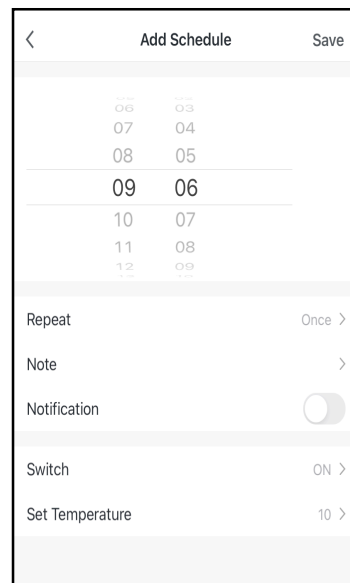
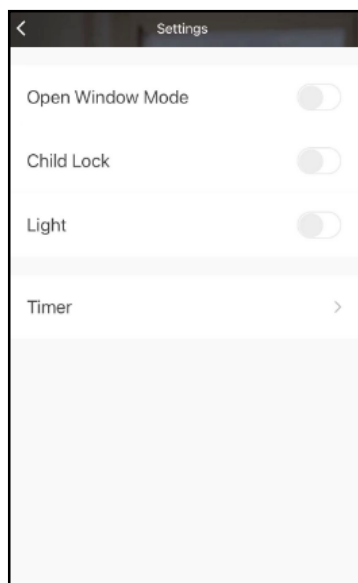
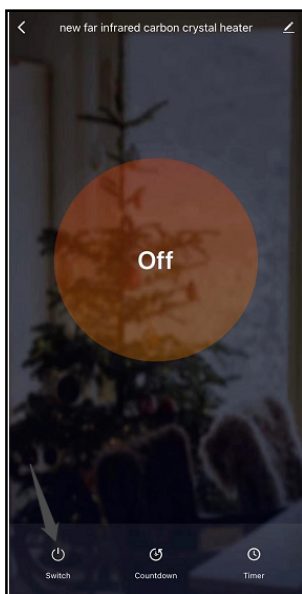
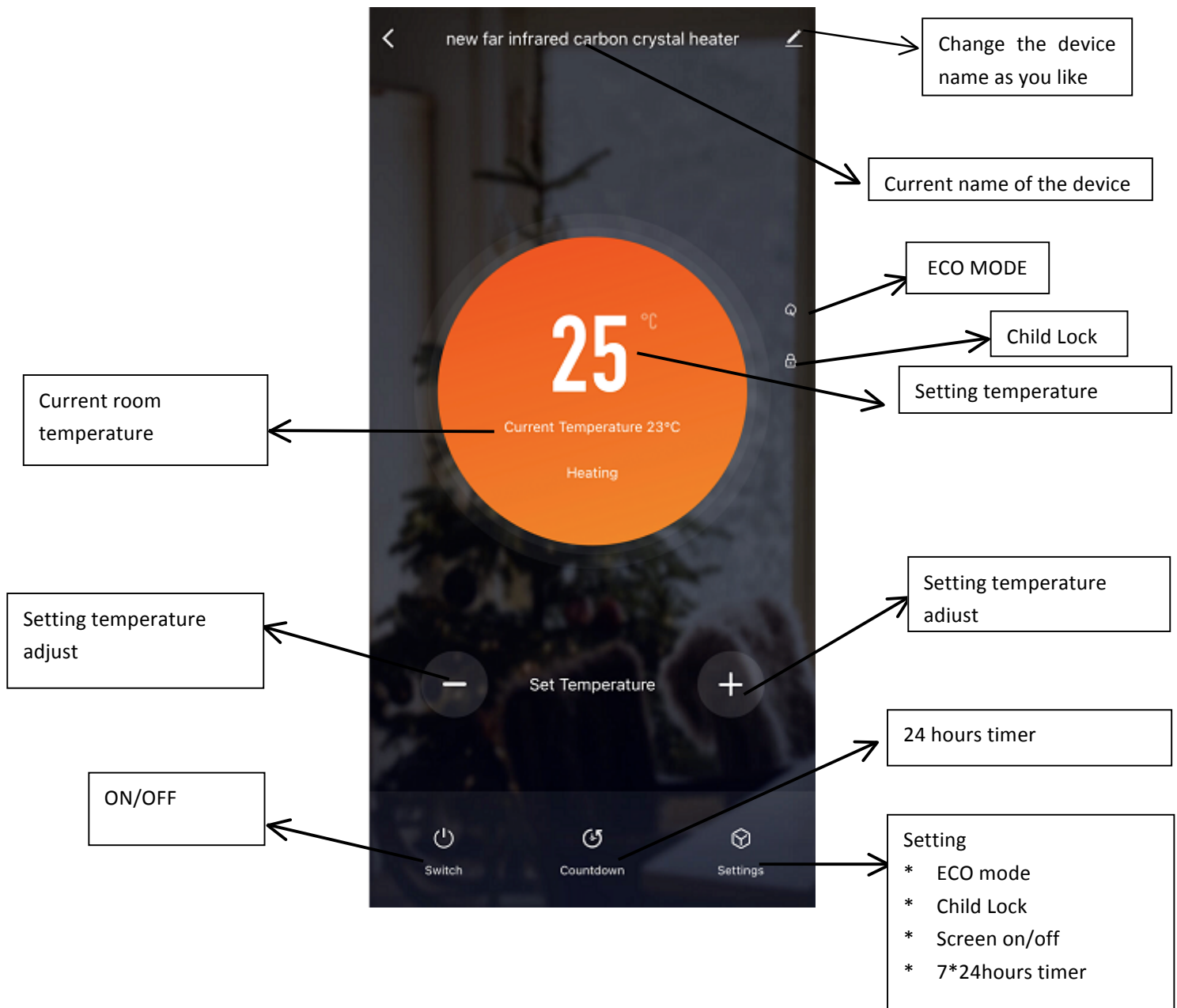

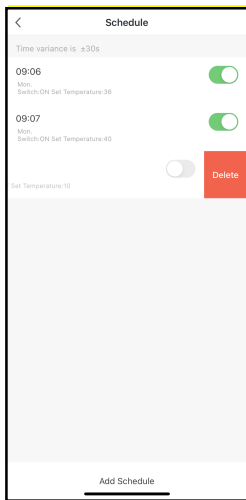
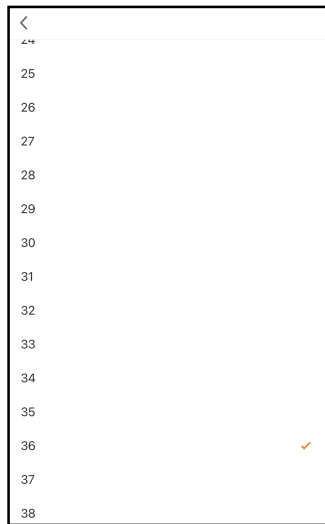
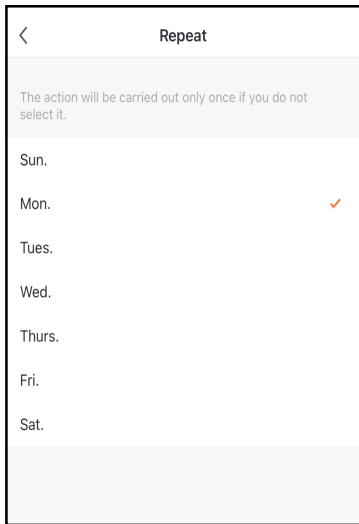

TROUBLES SHOOTING

If your heater fails to operate, please follow these instructions:

- Ensure that your circuit breaker or fuse is working properly.
- Be sure the heater is plugged in and that the electrical outlet is working properly.
- If the ON/OFF switch is not illuminated at ON position, contact service center for reparation directly.

NOTE: IF YOU EXPERIENCE A PROBLEM WITH YOUR HEATER, PLEASE CONTACT THE POINT OF SALE TO CHECK WARRANTY STATUS AND SEEK FURTHER ADVICE. PLEASE DO NOT ATTEMPT TO OPEN OR REPAIR THE HEATER YOURSELF. DOING SO MAY VOID ANY WARRANTY AND COULD CAUSE DAMAGE OR PERSONAL INJURY.

CLEANING AND STORAGE

Before cleaning your heater, switch off the heater and allow it to cool. Disconnect the electricity supply to the appliance. The outside can be cleaned by wiping it over with a soft damp cloth and then dried. Do not use abrasive cleaning powders or furniture polish, as this can damage the surface finish.

SPECIFICATIONS

Model No.: **BIR-480GB**: 220-240V/50Hz, 480W, IP44

Model No.: **BIR-600GB**: 220-240V/50Hz, 600W, IP44

Model No.: **BIR-720GB**: 220-240V/50Hz, 720W, IP44

PACKING LIST

Heater: 1 piece

Instruction manual: 1 piece

Remote Control: 1 piece

Accessories pack 1 set:

- 4 x rawlplug
- 4 x large metal screws for wall hanging
- 2 x feet
- 8 x small metal screws for attaching feet

Correct disposal of this product



This marking indicates that this product should not be disposed with other household wastes throughout the UK. To prevent possible harm to the environment or human health from uncontrolled waste disposal, recycle it responsibly to promote the sustainable reuse of material resources.

Warranty Information

The manufacturer provides warranty in accordance with the legislation of the customer's own country of residence, with a minimum of 1 year, starting from the date on which the appliance is sold to the end user.

The warranty only covers defects in material or workmanship.

The repairs under warranty may only be carried out by an authorised service center. When making a claim under the warranty, the original bill of purchase (with purchase date) must be submitted.

The warranty will not apply in cases of:

- Normal wear and tear
- Incorrect use, e.g. overloading of the appliance, use of non-approved accessories
- Use of force, damage caused by external influences
- Damage caused by non-observance of the user manual, e.g. connection to an unsuitable mains supply or non-compliance with the installation instructions
- Partially or completely dismantled appliances