

③

②

①



Hx12



Gx4

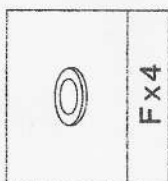

Fx4

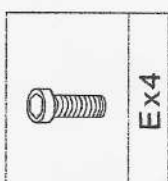

Ex4

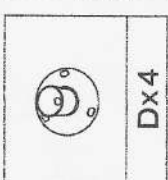

Dx4



Cx4

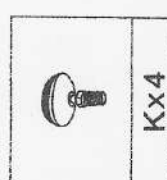

Kx4



Bx1

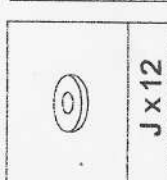



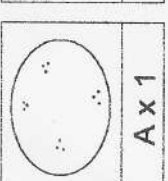

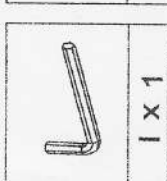

Jx12



Ax1



I x 1

A		M6*30mm	x2
B		M6*40mm	x1
C		M6*50mm	x4
D			x4
E			x5
F		5#	x1

\*\*\* Use of power tool  
will invalidate your claim .



Finish

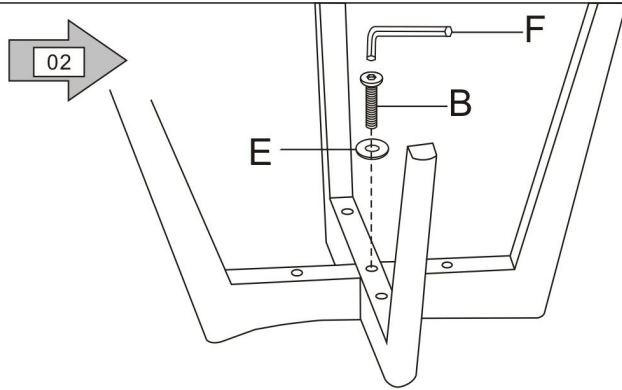
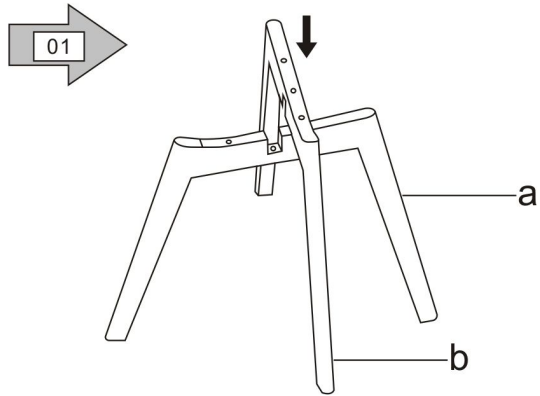
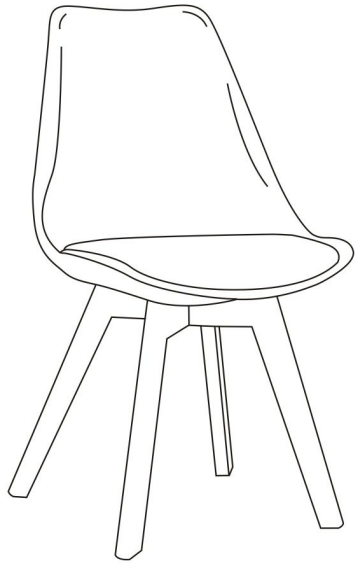

\*Make the screw 90% tight.

B		x1	E		x1	F		x1
---	--	----	---	--	----	---	--	----

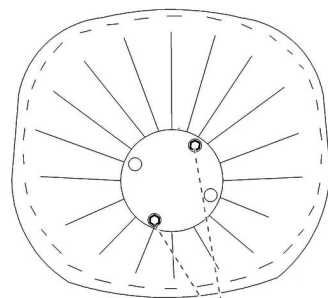



Front



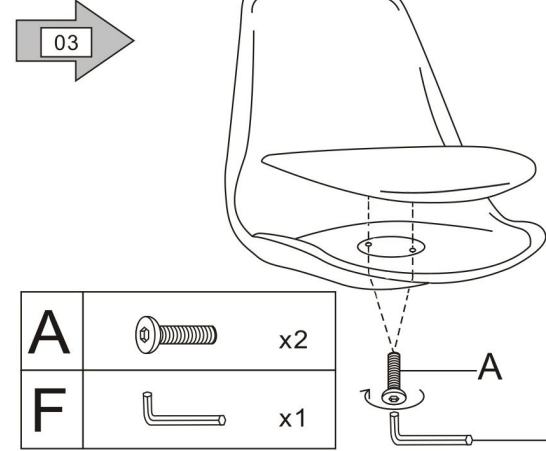



2 screws for the cushion

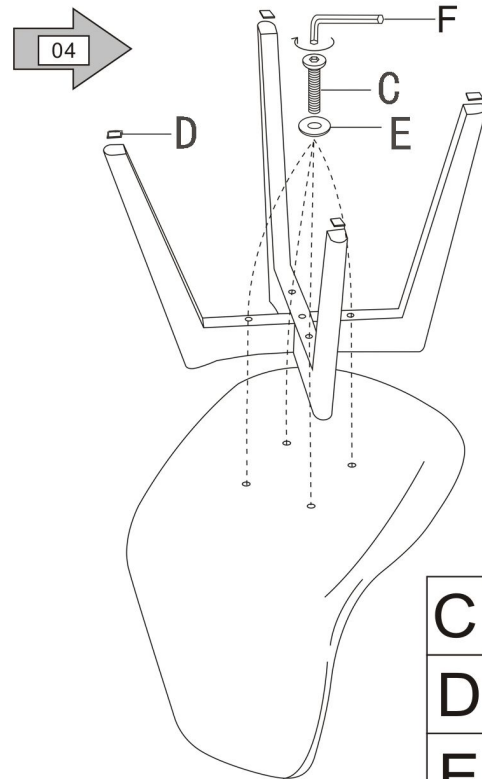

A		x2
F		x1



\*Make all screws  
100% tight.

C		x4
D		x4
E		x4
F		x1