

05 : 00

estimated
assembly time



1 or more

people required

Ok, let's
get started!



- Put on mood music!
- To prevent damage to product, use the clean side of package carton or rug as working surface.
- In the event of missing or damaged parts, delivery problems etc., please reach out to our team. We will be happy to fix the problem!

care guide

- Clean regularly with a soft and dry cloth.
- To protect finish, avoid use of abrasive cleaners.
- Wipe up spills immediately. Please!

ⓘ **While assembling the product, tighten the bolts up to 50%. Once all parts are in place, only then fully tighten the bolts.**



product parts

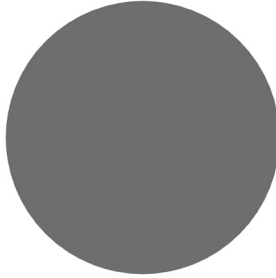

(A)
Table Top

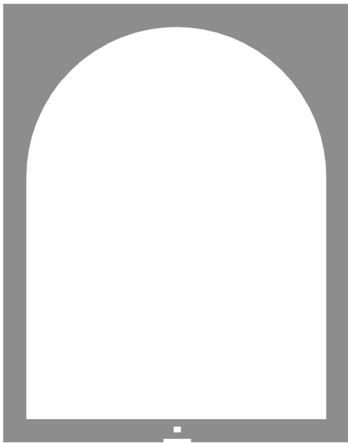

(B)
Leg 1

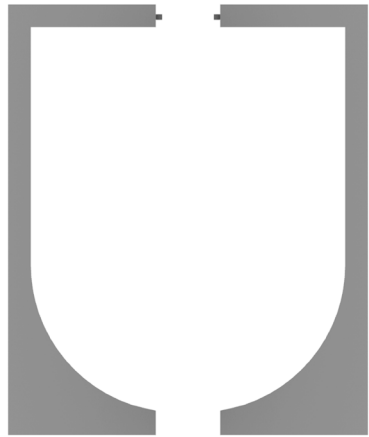

(C1)
Leg 2

(C2)
Leg 3

what's included



(D) - Metal Strip
x1



(E) - JCB Bolt
(6 x 60mm)
x4



(F) - Washer
(8 x 16mm)
x4



(G) - CSK Bolt
(6 x 12mm)
x3



(H) - Allen Key
x1

assembly instructions

Friendly Tip: Take a deep breath going in. This may be a tricky part, but nothing too overwhelming. Just follow these steps to the T and the outcome will be worth it!



- ⓘ While assembling the product, tighten the bolts up to 50%. Once all parts are in place, only then fully tighten the bolts.

step 1:

Start by placing the leg (B) upside down on a flat surface. Take the leg (C1) & (C2) and place them parallel to each other with the leg (B) between. Insert the tenons on the legs (C1, C2) into the mortis on the legs (B). Take the image below as reference.

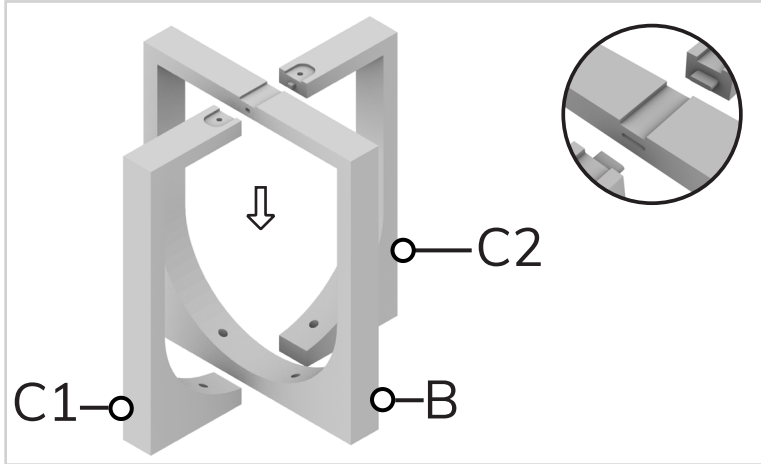

step 2:

Now, align them together as shown in the image and place the metal plate over the slots. Make sure the sticker on the metal stripe (D) is facing upwards. Now, insert bolts (G) and tighten them up to 50% to fix the legs together.

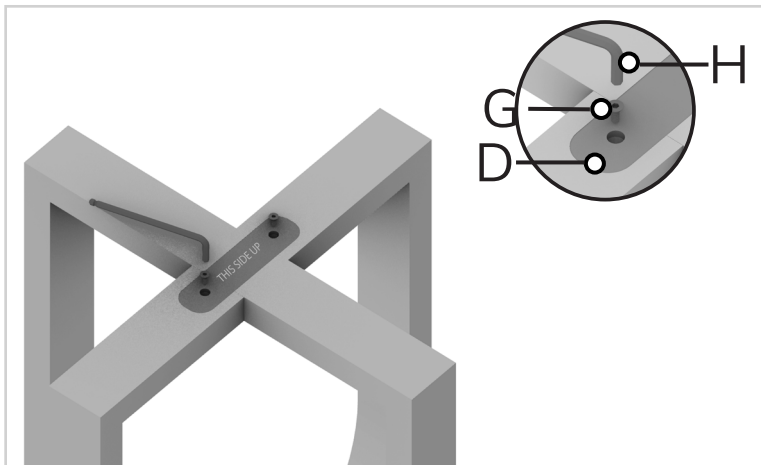

step 3:

Simple enough? Next, take the tabletop (A) and place it upside down on a flat surface. Take the legs and place them over the tabletop. Ensure that the holes on the legs align with the slots on the tabletop.

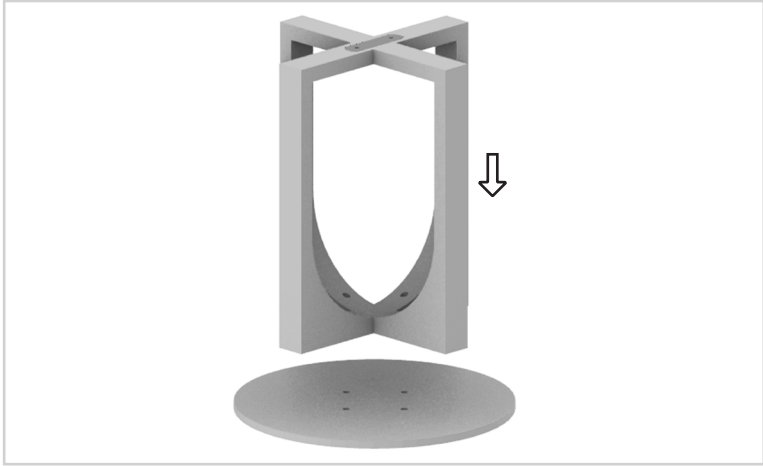

step 4:

When done, insert washer (F) & bolts (E) and tighten all the bolts using an allen key (H).

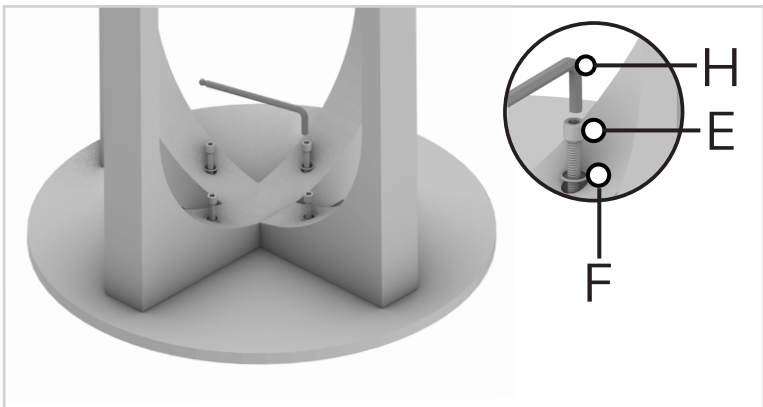

If required, adjust the leveller according to the floor.

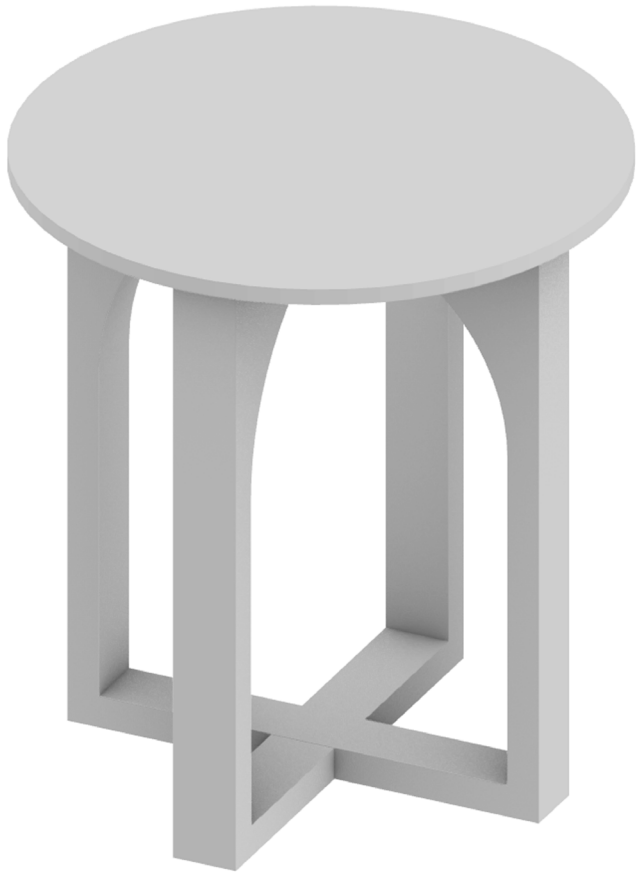

Voila! Your table is now assembled and secure!

you've
got
a home
with us

