

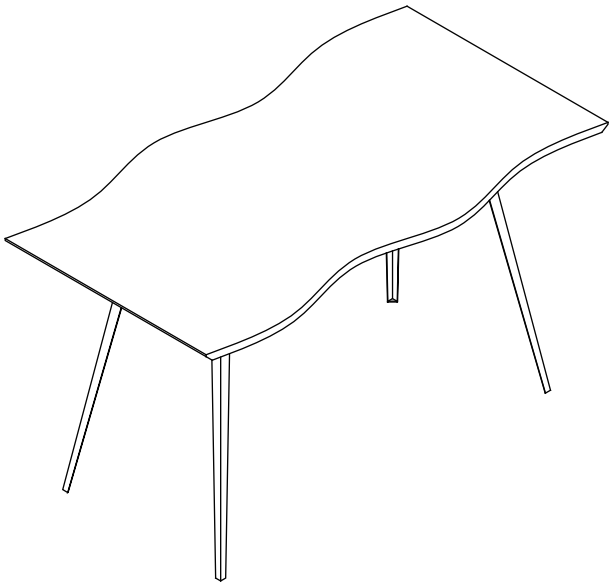

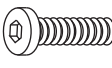



ASSEMBLY INSTRUCTION

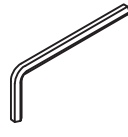
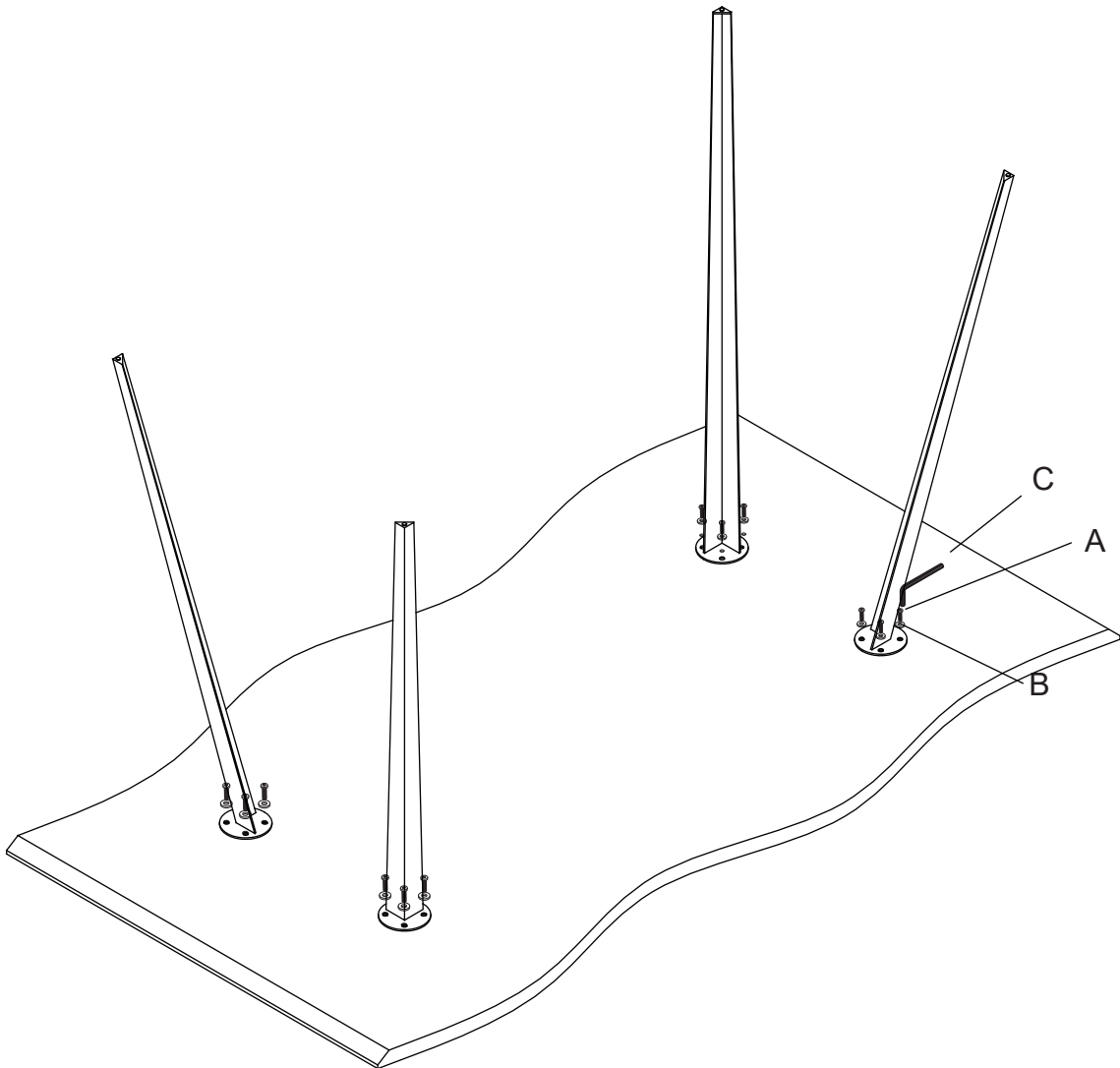

A*16	B*16	C*1
		

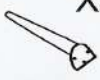
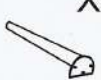

ASSEMBLY INSTRUCTION

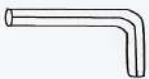
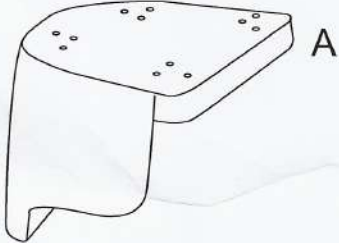
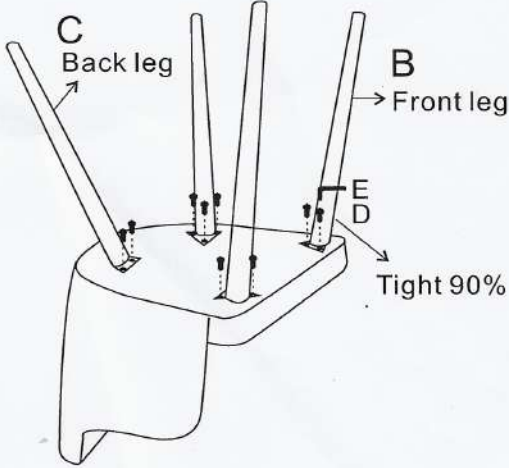
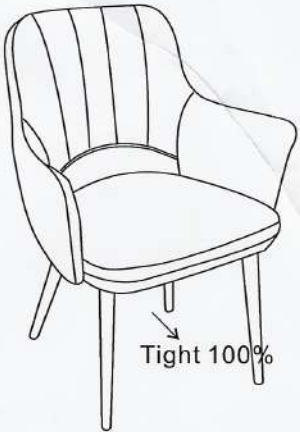
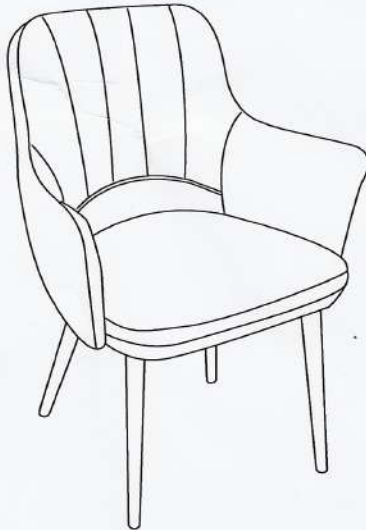
	<p>A X1</p> 	<p>B X2</p>  <p>Front leg</p>	<p>C X2</p>  <p>Back leg</p>	<p>D X12</p>  <p>6*14mm</p>	<p>E X1</p> 
<p>STEP1</p> 		<p>STEP2</p> <p>Tighten the screws just 90%</p> 			
<p>STEP3 *</p> <p>Place the chair on a flat surface Make sure the chair is stable Tighten the screws to 100%</p> 		<p>STEP4</p> 			

Use of power tool will invalidate your claim

