

DMD  
COLLECTIVE

DMD131

---

# Handheld Steam Cleaner

---

Information for use





Thank you for purchasing this Handheld Steam Cleaner from DMD Collective. The steam cleaner is designed for removing dirt with water vapor. Perfect for tiles, glazed tiles, windows, mirrors, hard to-reach areas and textiles.

Please read through ALL the information in this document and keep it for future reference.

## Health and Safety Guidelines

- Always unplug the unit when not in use, before cleaning, or when adding or removing parts. Please read the instructions carefully before using any appliance.
- Always ensure that the voltage on the rating label corresponds to the mains voltage in your home.
- Incorrect operation and improper use can damage the appliance and cause injury to the user.
- The appliance is intended for household use only. Commercial use invalidates the warranty, and the supplier cannot be held responsible for injury or damage caused when using the appliance for any other purpose than that intended.
- Do not let children use this appliance. Danger of scalds.
- Check the power cord and plug regularly for any damage. To prevent an electrical hazard, the manufacturer will need to replace the cord or plug if it is damaged.
- Do not use the appliance if it has been dropped or damaged in any way. If the unit is damaged, take it in for examination and/or repair by an authorized service agent.
- To reduce the risk of electric shock, do not immerse or expose the motor assembly, plug, or power cord to water or any other liquid.
- Never immerse the unit in water or any other liquid for cleaning purposes. Do not reach for an appliance that has fallen into the water. Unplug immediately.
- Remove the plug from the socket by gripping the plug. Do not pull on the cord to disconnect the appliance from the mains.
- Injury, fire, or electric shock could result from the use of accessory attachments that the manufacturer has not approved or supplied.
- A short cord is provided to reduce the hazards resulting from becoming entangled in or tripping over a longer cord.
- Do not let the cord hang over the edge of a table or counter.
- Ensure that the cord is not in a position where it can be pulled inadvertently.
- Do not allow the cord to touch hot surfaces, and do not place it on or near a hot gas or electric burner or in a heated oven. Do not place the unit on a hot surface.
- This appliance is not suitable for outdoor use. Do not use this appliance for anything other than its intended purpose.
- Do NOT carry the unit by the power cord.
- Do not leave this appliance unattended during use. An appliance should never be left unattended when plugged in.
- The manufacturer does not accept responsibility for any damage or injury caused by improper or incorrect use or for repairs carried out by unauthorised personnel.
- In the event of technical problems, switch off the appliance and do not attempt to repair it yourself. Return the appliance to an authorised service facility for examination, adjustment, or repair.
- Always insist on the use of original spare parts. Failure to comply with the above-mentioned precautions and instructions will affect the safe operation of this machine.
- We do not recommend using extension cords with this product.
- Never use the product with liquids other than water. Do not operate the steam cleaner with an empty tank.
- Do not operate the steam cleaner with an external timer or separate remote control system.
- Never point the steam directly at electric devices or furnishings containing electric parts such as the inside of ovens.
- Never remove the safety cap when steam is still being emitted from the steam nozzle.
- Do not touch the hot parts of the steam cleaner during operation. Keep in mind that hot steam is also able to escape from the steam cleaner after you have turned it off.

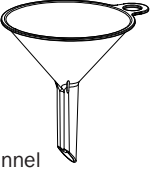
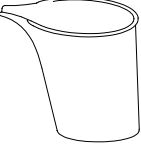
## Parts & Accessories

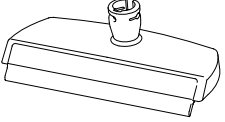
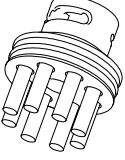
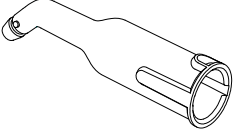
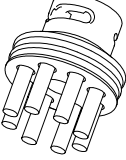
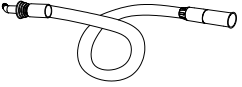
 <ul style="list-style-type: none"> <li>• Funnel</li> </ul>	 <ul style="list-style-type: none"> <li>• Measuring Jug</li> </ul>	 <ul style="list-style-type: none"> <li>• Towel Set</li> </ul>	 <ul style="list-style-type: none"> <li>• Glass Cleaner</li> </ul>
 <ul style="list-style-type: none"> <li>• Nylon Brush</li> </ul>	 <ul style="list-style-type: none"> <li>• Big Nozzle</li> </ul>	 <ul style="list-style-type: none"> <li>• Stainless Brush</li> </ul>	 <ul style="list-style-type: none"> <li>• Extension Hose</li> </ul>

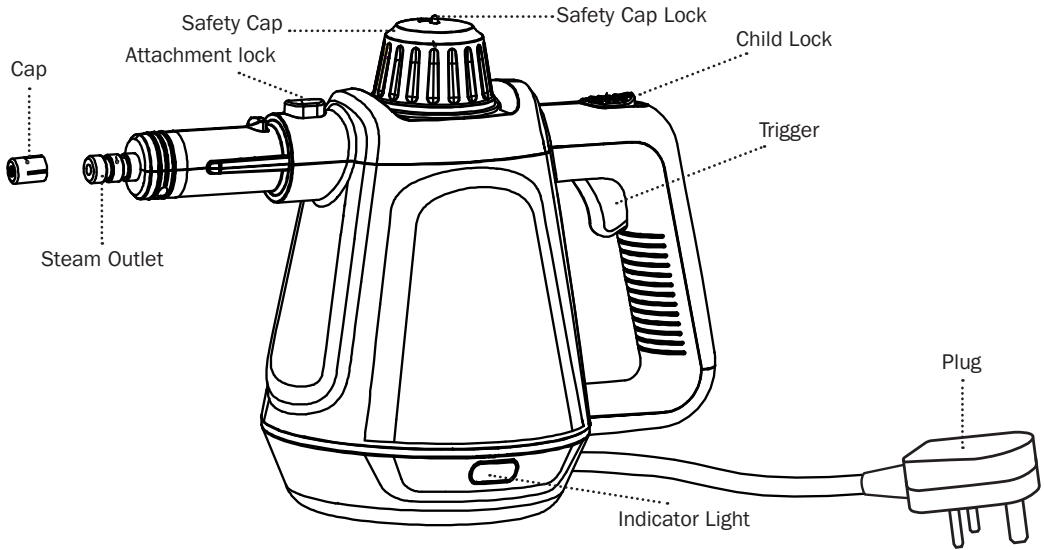

## Before Using For the First Time

Before cleaning any surface with your steam cleaner, it's important to test a small area to ensure the material is suitable for steam cleaning. This will help prevent potential damage. Here are some materials that may be sensitive to steam:

- Lacquered Wood or Leather: Steam can cause fading.
- Unprotected Wood: Steam can cause swelling.
- Waxed Surfaces: Steam can remove protective wax layers.
- Plastics: Steam may cause discolouration or warping, especially on soft plastics.
- Acrylic, Velvet, and Satin: These fabrics are sensitive to heat and may be damaged by steam.
- Glass or Mirrors: Rapid temperature changes can cause cold glass or mirrors to crack.

**PLEASE NOTE:** To safely clean windows with steam, warm up the entire glass surface by applying steam from a greater distance. Once the glass is warm, gradually move closer for a more focused cleaning action.

## Operation

1. Unpack the package, verify that all the accessories are present, and ensure that neither the product nor the accessories are damaged.
2. Put the steam cleaner on a level platform and open the safety cap by twisting it counterclockwise. Then, using the funnel and measuring cup, fill it with water. The maximum tank capacity is 400ml, but we suggest you only fill the tank with 300–350ml to get dry steam. If there's more than 350ml of water, the steam may have water for the first 2 minutes. Please use clean water. If the tap water in your area is extremely hard, we recommend mixing it with distilled water. Otherwise, the steam cleaner could calcify prematurely and clog the steam nozzle.
3. Reinstall the safety cap and tighten it in place.
4. Plug the steam cleaner into the mains, and the indicator light will turn red, indicating that the steam cleaner is heating up and pressure is increasing. The safety cap lock will pop up. After about 3 minutes of heating, the red indicator light turns green, indicating that the machine is ready for use. **Only use the machine when the indicator light is green.**
5. After the heating is complete, select the accessory you need and install it on the unit.
6. Turn the child lock to the “ON” (backwards) position, then press the trigger. Steam will be released. Once you release the trigger, the child lock will turn back to the “OFF” position automatically, and the machine will stop. **You can't use the trigger without turning on the child lock.**
7. After usage, please turn the power off, release all the residual steam and **wait for the machine to cool down.**

## Refilling The Water Tank

If you run out of water during use, the steam cleaner must be refilled as follows:

1. Unplug the steam cleaner.
2. Push the steam trigger until no more steam is escaping. The safety cap lock will go down.
3. Wait for the steam cleaner to cool (**at least 12-18 minutes**).
4. Slowly unscrew the safety cap and wait a few seconds.
5. Slowly refill the water using the jug & funnel (Fig. 1).
6. Close the safety cap again.

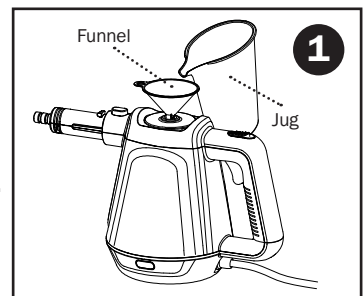

## Cleaning & Storage

1. Before cleaning, unplug the steam cleaner.
2. Let the steam cleaner cool off completely.
3. Wipe the steam cleaner and the accessories off with a damp cloth. Then let all parts dry completely.
4. All parts must be completely dry before being stored. Always store the steam cleaner in a dry, clean and dust-free place out of the reach of children.

# Attaching Accessories

Before adding each accessory on the unit, please take off the cap on the nozzle first.

## Extension Hose

- If you want to clean a hard to reach area, you can use the extension hose. Connect the end of the hose to the steam outlet until you hearing a clicking sound (Fig. 2).

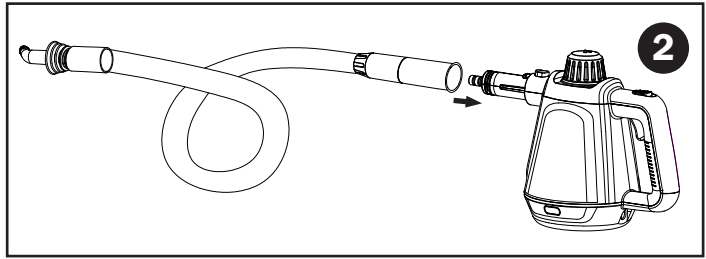

## Big Nozzle

- The big nozzle can be used to clean corners easily. Connect the end of the big nozzle to the steam outlet until you hearing a clicking sound (Fig. 3).

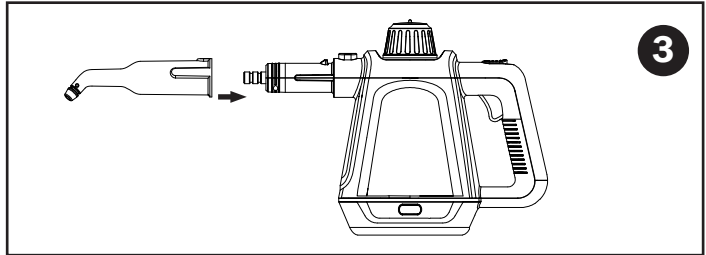

## Glass Brush

- Insert the big nozzle into the notch of the glass cleaner (Fig. 4), and turn it clockwise until it clicks (Fig. 5). After use, remove the glass brush by turning it anti-clockwise.
- For cleaning desks, chairs, bookcases, or ironing clothes, you can put the towel over the glass cleaner (Fig. 6).

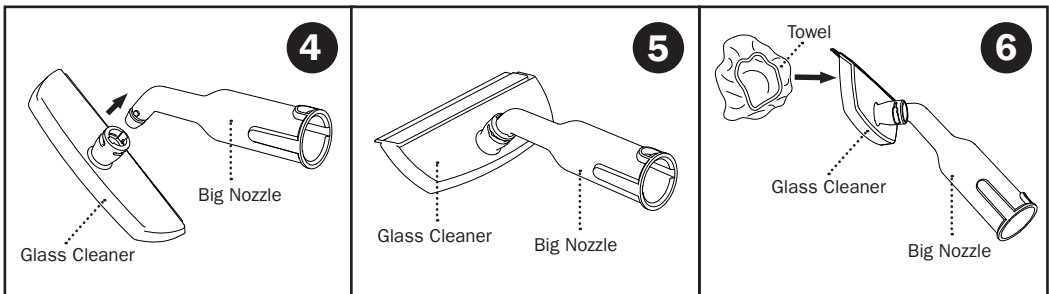

## Nylon & Stainless Brushes

- Insert the big nozzle into the notch of the round brush and turn it clockwise until it clicks (Figs. 7 & 8). After use, remove the round brush by turning it anti-clockwise.

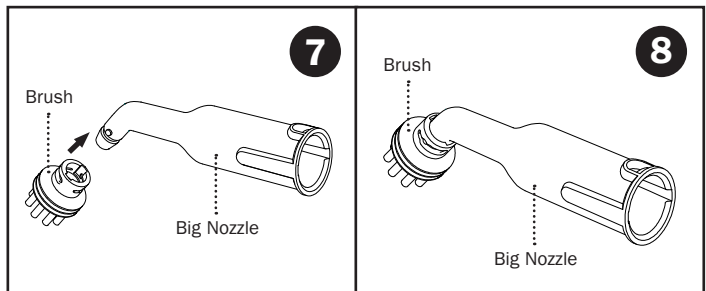

## Steam Temperature

See Fig.9 for an approximate guide to the steam temperature at various distances.

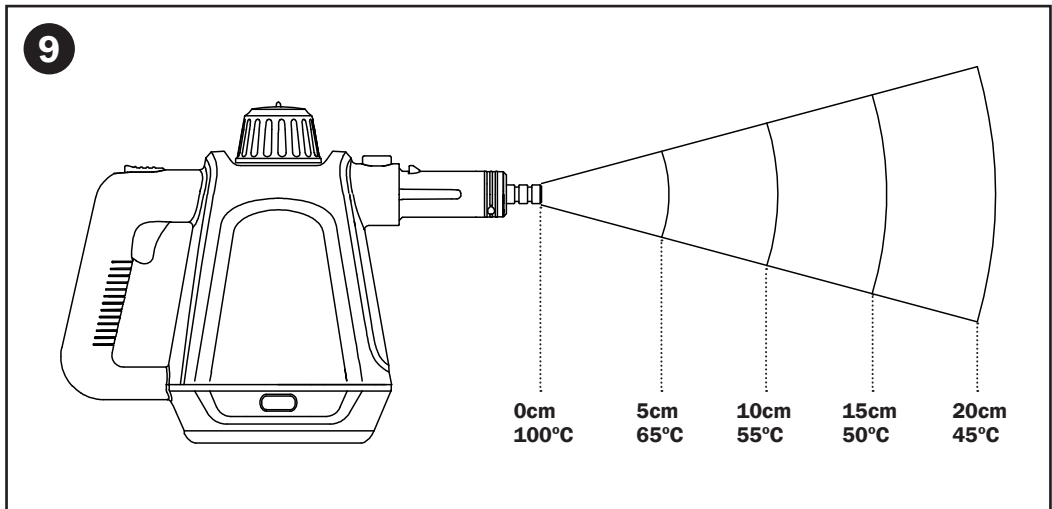

## Troubleshooting

Problem	Solution
No steam.	<ul style="list-style-type: none"><li>• Check the cleaner is plugged in.</li><li>• Check the cleaner has water.</li><li>• Make sure the child lock is on.</li></ul>
The green indicator light is permanently on.	<ul style="list-style-type: none"><li>• The indicator light has broken, needs professional repair.</li></ul>
The red indicator light is permanently on.	<ul style="list-style-type: none"><li>• The thermostat is broken, needs professional repair.</li></ul>
The red indicator light is flickering.	<ul style="list-style-type: none"><li>• Check the cleaner has water.</li></ul>
Water is flowing from the nozzle.	<ul style="list-style-type: none"><li>• This is normal when the cleaner is used for the first time or when the cleaner has not used for a long period of time.</li><li>• Do not overfill the water tank.</li></ul>
Steam is coming out of the safety valve or parts of the cleaner other than the nozzle.	<ul style="list-style-type: none"><li>• Needs professional repair.</li></ul>

## Technical Support

If you require any technical support for your product within the warranty period, please contact us on [support@dmdcollective.co.uk](mailto:support@dmdcollective.co.uk) and provide the product name and supplier code (see Technical Specifications) along with the technical query and proof of purchase.

## WEEE



The WEEE symbol  on this product means that this unit should be ethically dismantled or recycled to minimise environmental impact. Please check with your local authority for more information.

## IMPORTANT: ADDITIONAL SAFETY INFORMATION

This device is **NOT** intended for use by persons (including children) with reduced physical, sensory or mental capabilities, or lack of experience and knowledge, unless they are supervised or have been given instruction concerning use of the device by a person responsible for their safety.

## Technical Specifications

<b>Product Name:</b>	DMD Handheld Steam Cleaner
<b>Supplier Code:</b>	DMD131
<b>Voltage:</b>	220V~240V
<b>Frequency:</b>	50/60Hz
<b>Wattage:</b>	1200W
<b>Water Jug Capacity:</b>	400ML
<b>Boiler Tank Capacity:</b>	450ML
<b>Heat Time:</b>	5mins
<b>Max Temperature:</b>	100°C



---

**Ace Supply Co Ltd.,**  
Suite GA, Marsland House  
Marsland Road, Sale M33 3AQ

---

**For Product Support:**  
**E:** [support@dmdcollective.co.uk](mailto:support@dmdcollective.co.uk)  
**T:** +44 (0)161 447 8597

**EU Regd. Address:** Ace Supply Co (Europe) Ltd.,  
25 Herbert Place, Dublin 2, D02 A098  
Republic of Ireland

---

[www.dmdcollective.co.uk](http://www.dmdcollective.co.uk)