

# Agri Barrow 120 Litre single

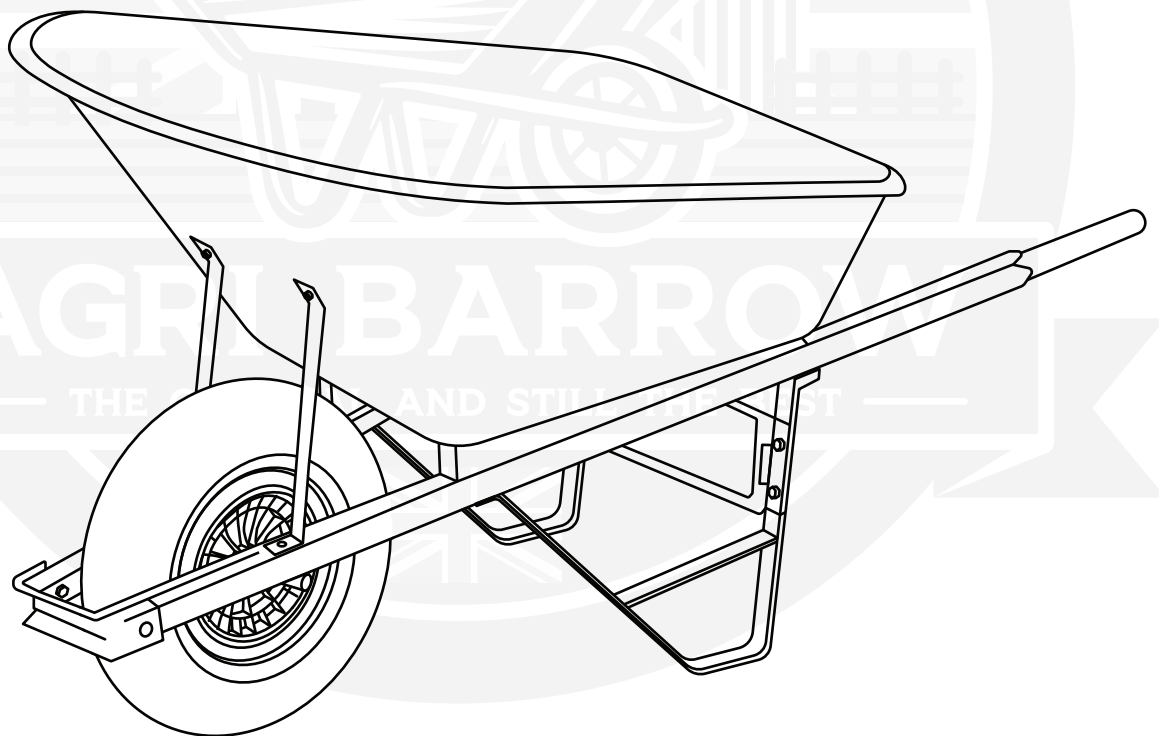

## Assembly Instruction

[www.agribarrow.com](http://www.agribarrow.com)

## About Agri Barrow™

At **Agri Barrow™**, we're proud to design and deliver high-performance wheelbarrows built for everyday reliability — whether you're in the garden, on the farm, or managing heavy-duty site work.

All our barrows are engineered with a focus on **durability, ease of use, and long-lasting materials**. We believe in products that work hard, last longer, and make your job easier. That's why every Agri Barrow™ is backed by our **Lifetime Warranty** — your guarantee of quality, strength, and peace of mind.

---

### Register for Lifetime Warranty

Activate your **Agri Barrow™ Lifetime Warranty** and unlock full product support by registering your purchase at:  
**[www.agribarrow.com/register](http://www.agribarrow.com/register)** STILL THE BEST

It only takes a moment and ensures your barrow is protected for life.

---

### Enjoy a Free Gift On Us!

We'd love to hear what you think! Leave us a **review or send in a video** of your Agri Barrow™ in action, and we'll send you a **FREE Agri Barrow™ Waterproof Cover (RRP £19.99)** as a thank you.

# Screws and Nuts: A Quick Overview

**A**

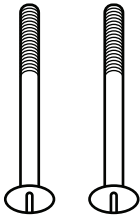

140 mm Bolts



Washers x2



Spring Washers x2



Nuts x2

**B**

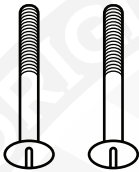

100 mm Bolts



Washers x2



Spring Washers x2



Nuts x2

**C**

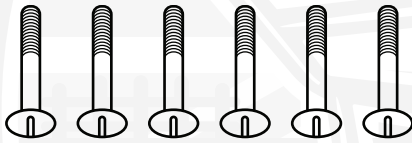

75 mm Bolts



Washers x6



Spring Washers x6



Nuts x6

**D**

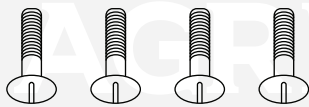

45 mm Bolts



Washers x4



Spring Washers x4



Nuts x4

**E**

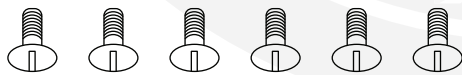

25 mm Bolts



Washers x6



Spring Washers x6



Nuts x6

# Components

1. Handle x2
2. Riser x2
3. Wheel Guard x1
4. Tray x1
5. Axle Bracket x2
6. Axle x1
7. Wheel x2
8. Leg Brace x1
9. Tray Brace x2
10. Leg x2

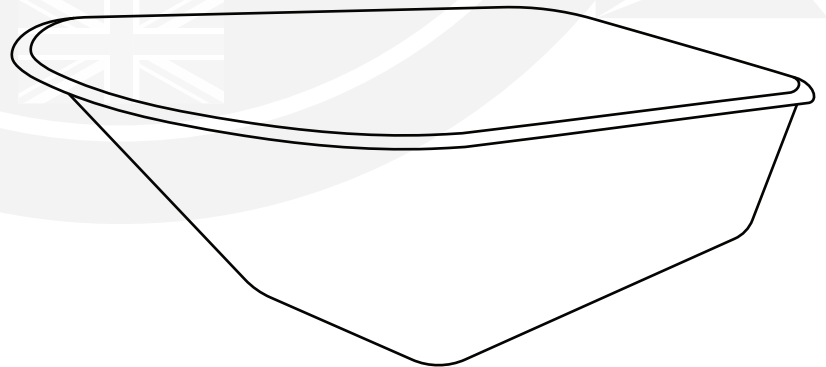
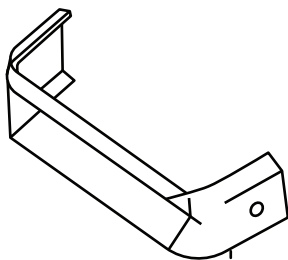
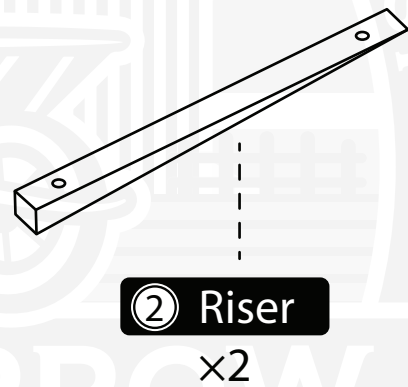
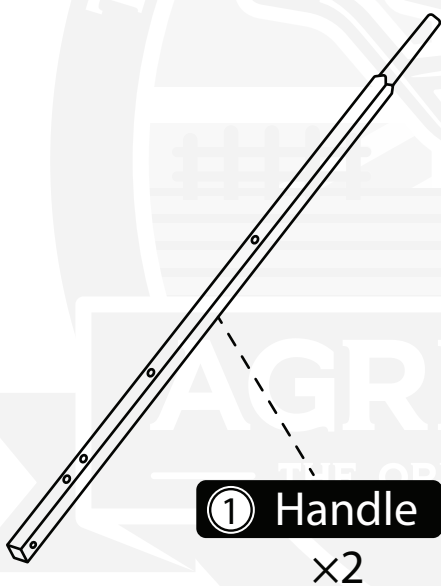

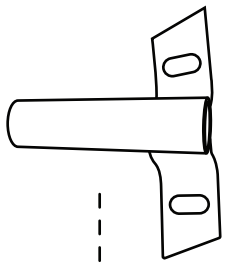

⑤ Axle Bracket

x2



⑥ Axle

x1

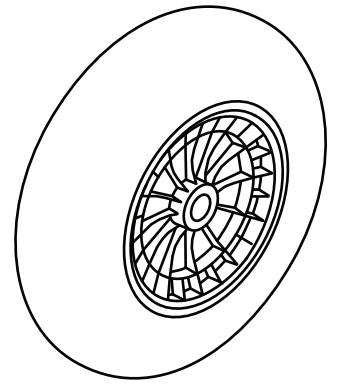

⑦ Wheel

x1

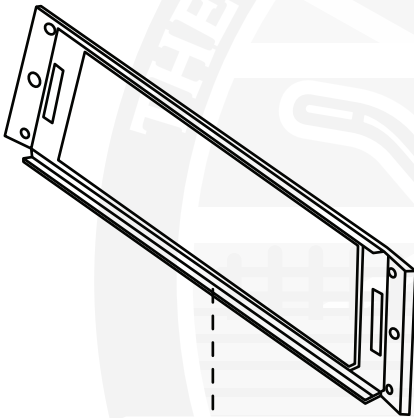

⑧ Leg Brace

x1



⑨ Tray Brackets

x2

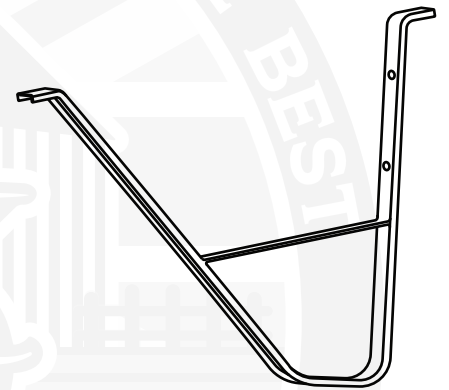

⑩ Leg

x2

## Before You Begin Assembly:

- Work on a flat, stable surface.
- Use a 13mm spanner or socket.
- Do not fully tighten any bolts until the assembly is complete.
- Having two people will make the process faster and easier.

## Step 01

Align Handle (1) with the Tray (4) and Riser (2), ensuring the handles face the back end.

Place the legs (10) on top of the Handle, making sure the leg brace holes are facing the rear of the base.

Align all bolt holes, then securely attach the legs, handle, and riser to the plastic base using four nuts and bolts. Use the 140 mm (A) bolts at the back and the 100 mm (B) bolts at the front.

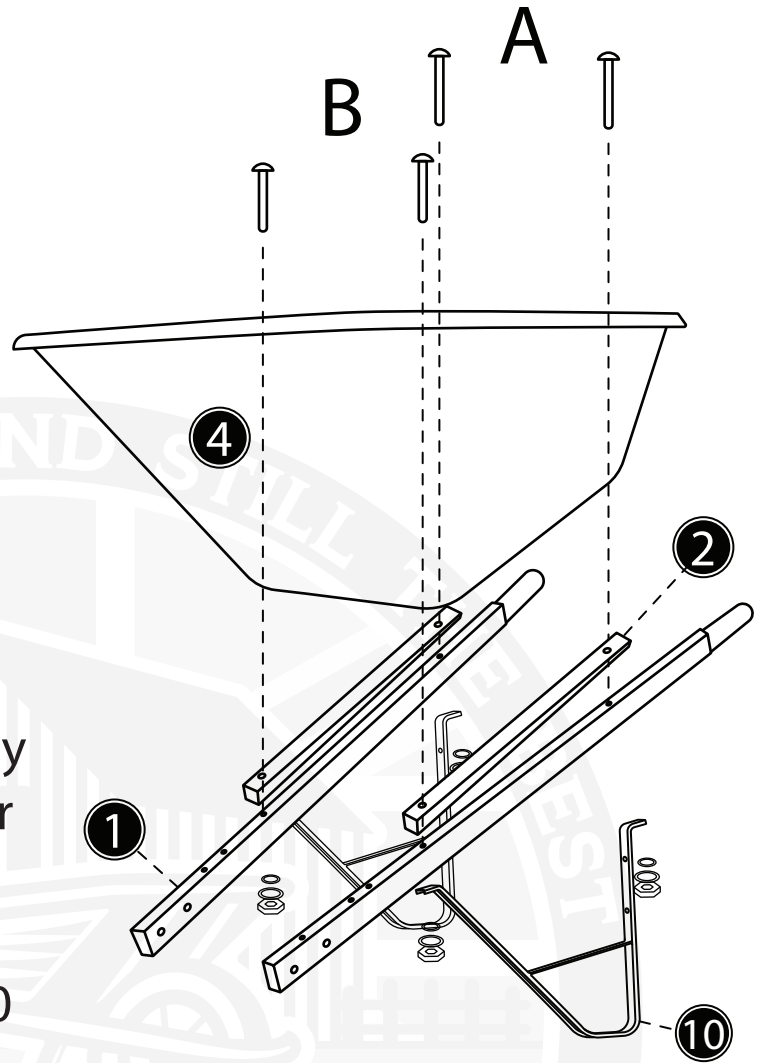

## Step 02

Secure the Wheel guard (3) to the front of the Handles using four 45mm (D) nuts and bolts inserted through the sides.

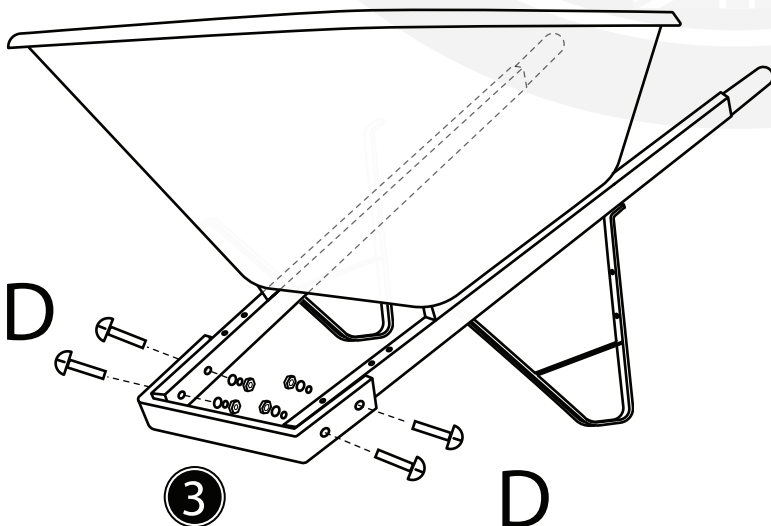

## Step 03

### Fitting the Axle

Place the axle(6) through the wheel(7) and slide in two axle brackets onto it. Attach the brackets to the front of the handles using four 75mm nuts and bolts(C)

**Important:** The axle brackets must point outwards towards the wheels. These act as spacers. Next, slide them outwards as far as they will go before tightening, to stop the wheels wobbling.

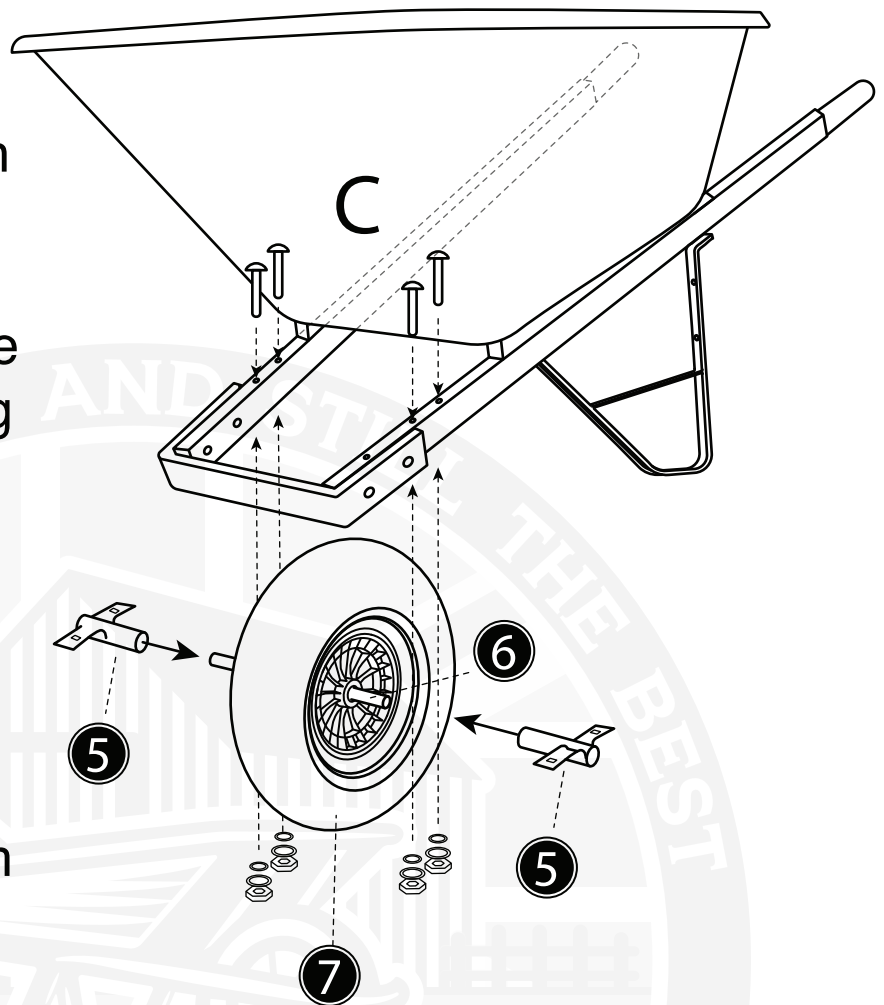

## Step 04

Position the leg brace (8) on the back side of the legs.

Align the holes and secure it using four 25mm (E) nuts and bolts.

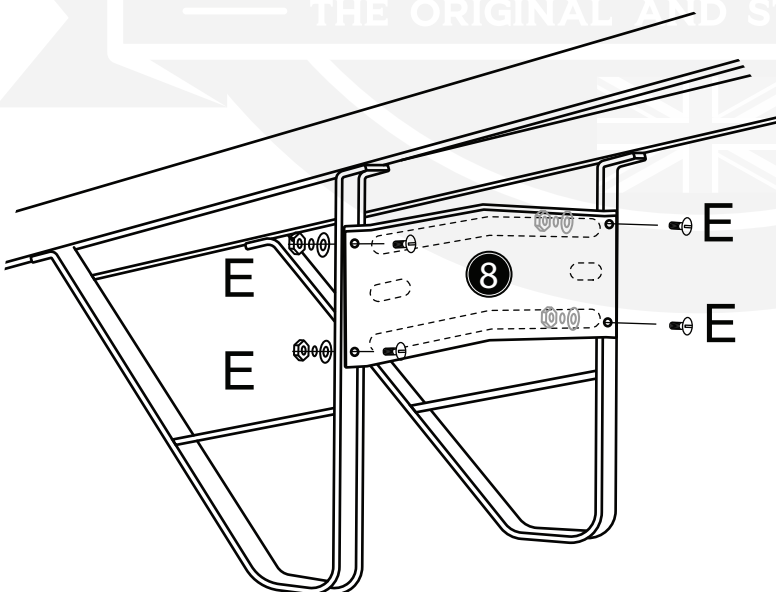

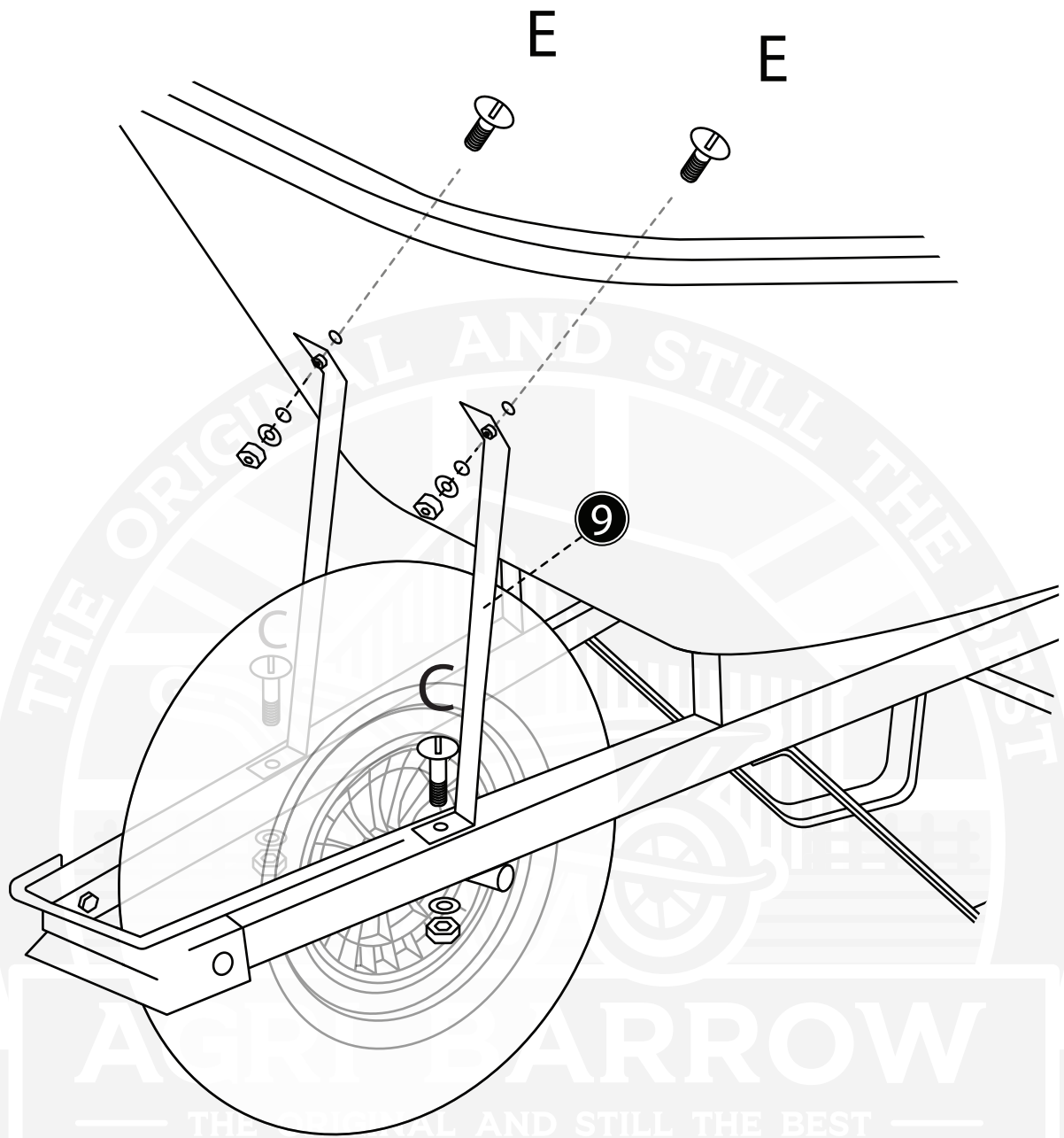

## Step 05

Attach the bottom side of the tray brackets (9) to the legs using two 75mm (C) nuts and bolts.

Position the other ends of the tray brackets onto the plastic base, then secure them together using two 25mm (E) nuts and bolts.