

# Installation Instruction

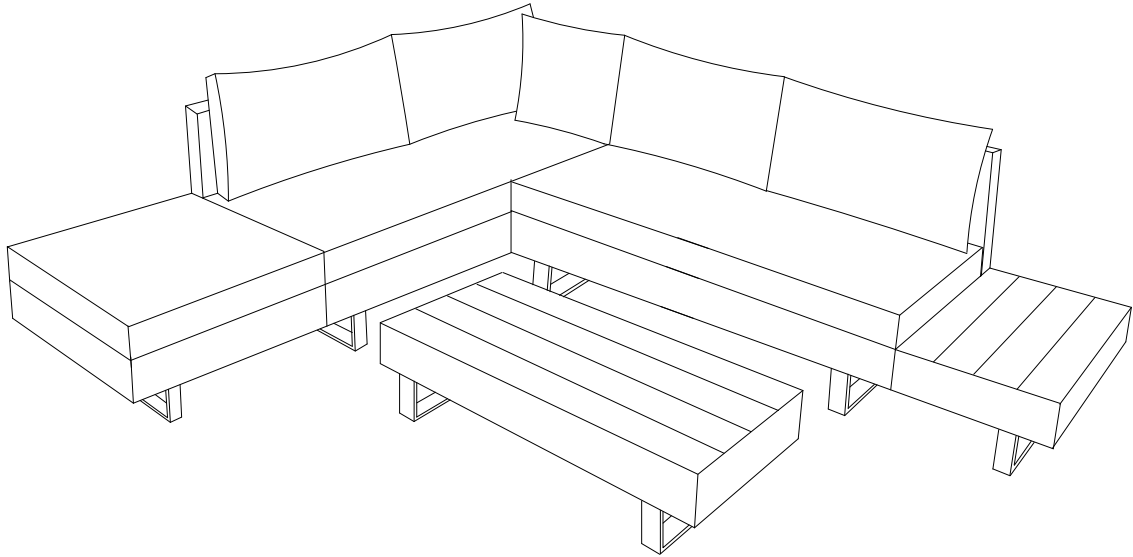

WF317183/WF317184/WF317185

## Tips

1. This product will be split into 3 packages for delivery. They may not arrive at the same time. Please wait patiently.

2. Thank you for shopping. We strive to provide you with high quality products. In rare cases that your product is damaged, missing parts or you encounter assembly problems, please contact our customer service with it. We will offer you the best solution as soon as possible.









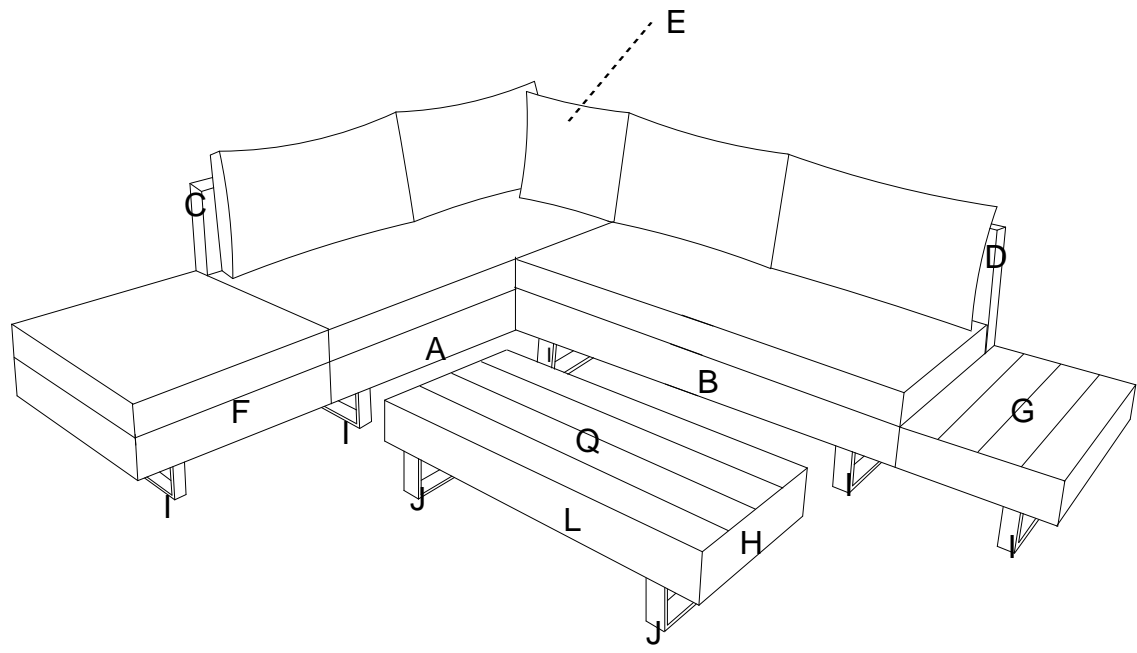

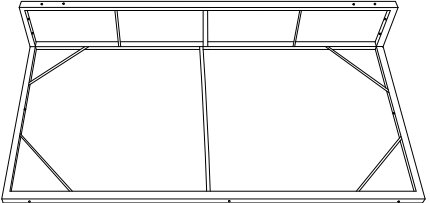
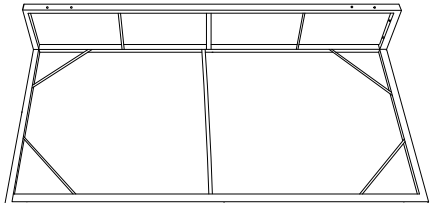
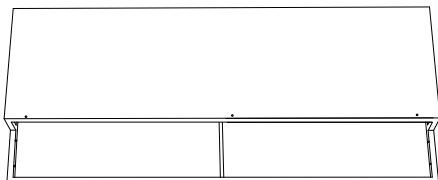
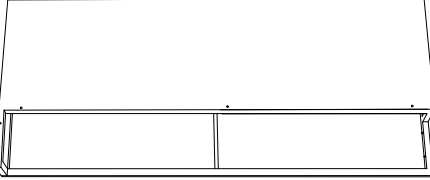
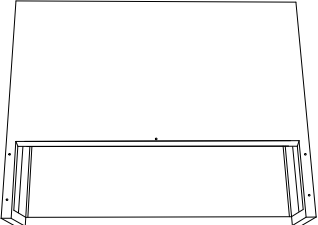
In order to solve your problem quickly, please provide us with some pictures that can clearly reflect the product problem.

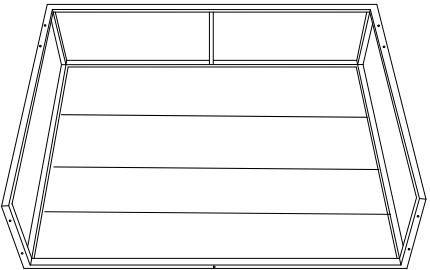
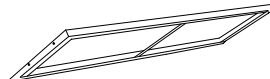
Thanks very much!

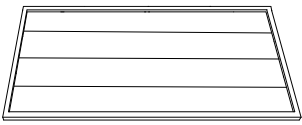
3. Insert the screws in holes and tighten the screws but not too tight, 70%~80% is ok. Finally tighten all the screws. If some issues happened that some screws can not target to the hole or some parts are difficult to install, please adjust the tightness of the screws.

4. 2 people are recommended to finish

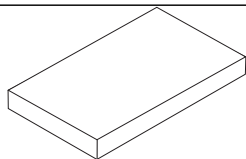
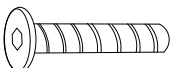
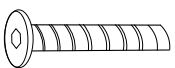
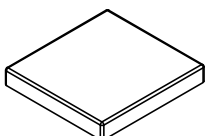
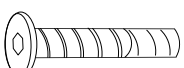

<p><b>A</b></p>  <p><b>X1</b></p>	<p><b>B</b></p>  <p><b>X1</b></p>	<p><b>C</b></p>  <p><b>X1</b></p>
<p><b>D</b></p>  <p><b>X1</b></p>	<p><b>E</b></p>  <p><b>X1</b></p>	<p><b>F</b></p>  <p><b>X1</b></p>
<p><b>G</b></p>  <p><b>X1</b></p>	<p><b>H</b></p>  <p><b>X2</b></p>	<p><b>I</b></p>  <p><b>X6</b></p>
<p><b>K</b></p>  <p><b>X1</b></p>	<p><b>Q</b></p>  <p><b>X1</b></p>	<p><b>J</b></p>  <p><b>X2</b></p> <p><b>Double Seat Cushion X2</b></p>
<p><b>L</b></p>  <p><b>X2</b></p>	<p><b>Back Cushion X5</b></p>  <p><b>X5</b></p>	<p><b>Seat Cushion X1</b></p>  <p><b>X1</b></p>
<p><b>M</b></p>  <p><b>M 6X35</b></p> <p><b>X31</b></p>	<p><b>N</b></p>  <p><b>M 6X16</b></p> <p><b>X32</b></p>	<p><b>O</b></p>  <p><b>X1</b></p>
<p><b>O</b></p>  <p><b>M 6X 50</b></p> <p><b>X 8</b></p>	<p><b>P</b></p>  <p><b>X 8</b></p>	<p><b>X1</b></p>  <p><b>X1</b></p>

# WF317183

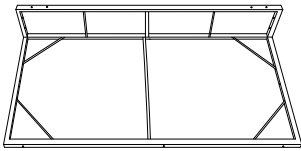

**Ax1**

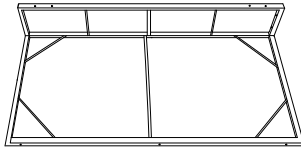

**Bx1**

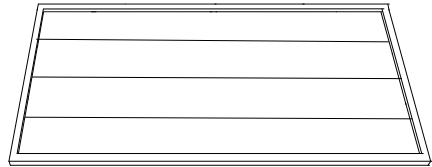

**Qx1**

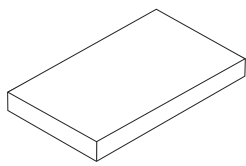

**Double Seat  
Cushion x2**

# WF317184

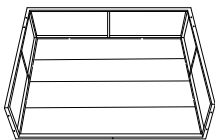

**Fx1**

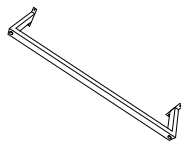

**lx6**

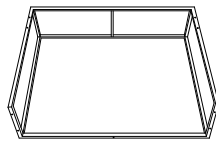

**Gx1**

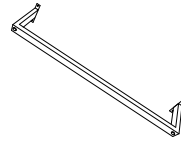

**Jx2**



**Back Cushion x2**

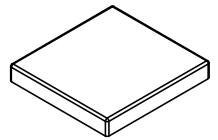

**Seat Cushion  
x1**

# WF317185

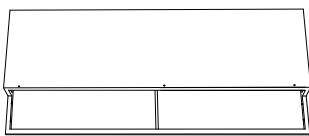

**Cx1**

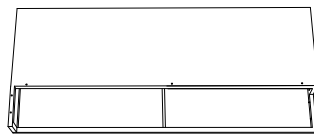

**Dx1**

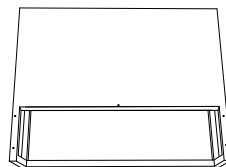

**Ex1**

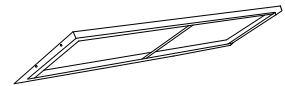

**Hx2**

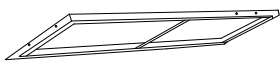

**Kx1**



**Lx2**



**Back Cushion  
x3**

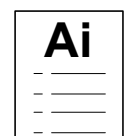

NOTE: 50% TIGHTEN BEFORE FIXING ALL BOLTS

1

M

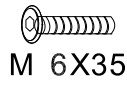

4 pcs

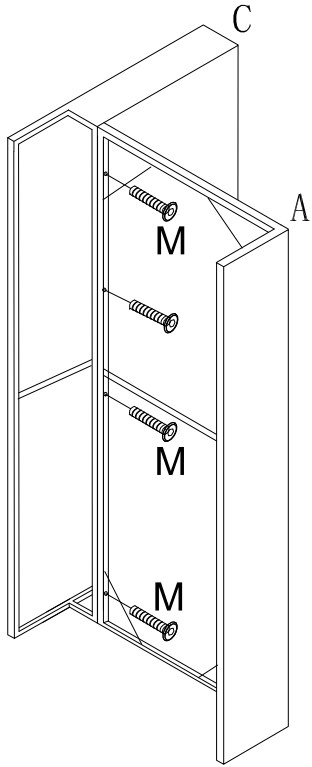

2

M

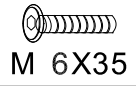

5 pcs

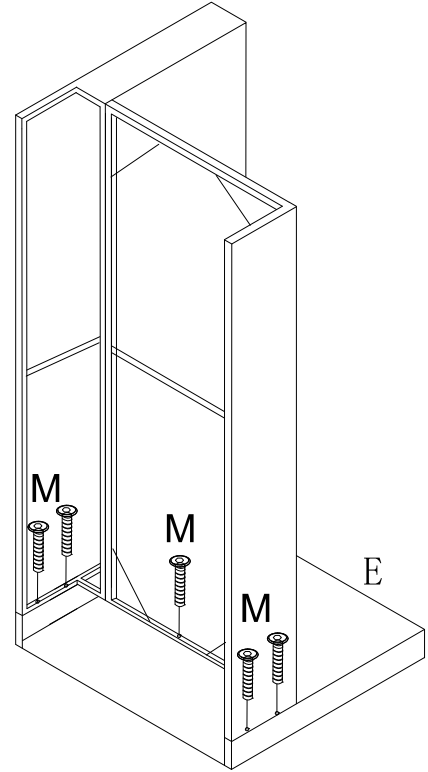

3

N



8 pcs

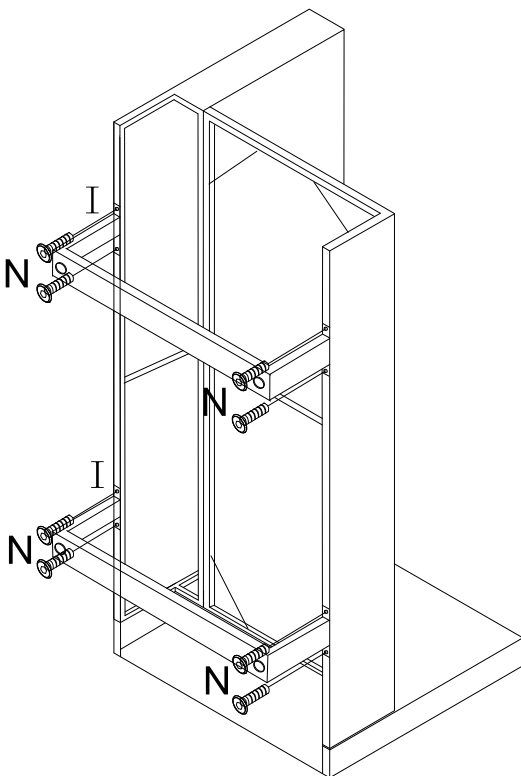

4

N

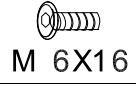

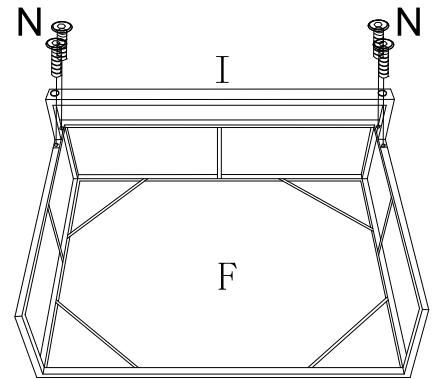

4 pcs



NOTE: 50% TIGHTEN BEFORE FIXING ALL BOLTS

5

O	 M 6X50	4 pcs
P		4 pcs
M	 M 6X35	1 pcs

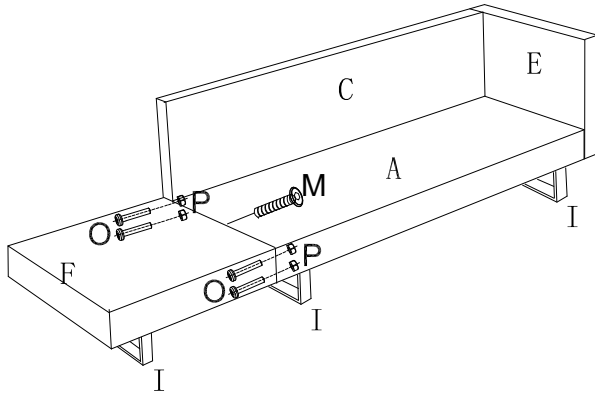

6

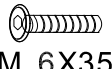
M	 M 6X35	8 pcs
---	---	-------

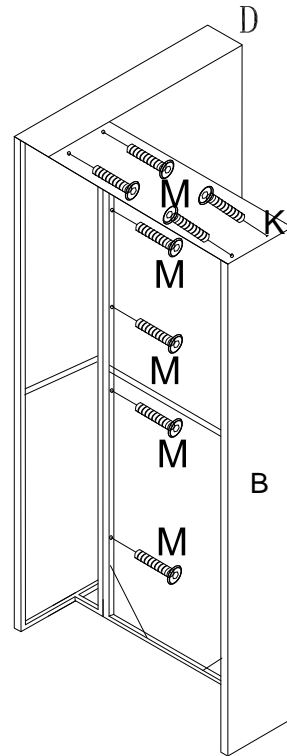

7

N	 M 6X16	8 pcs
---	---	-------

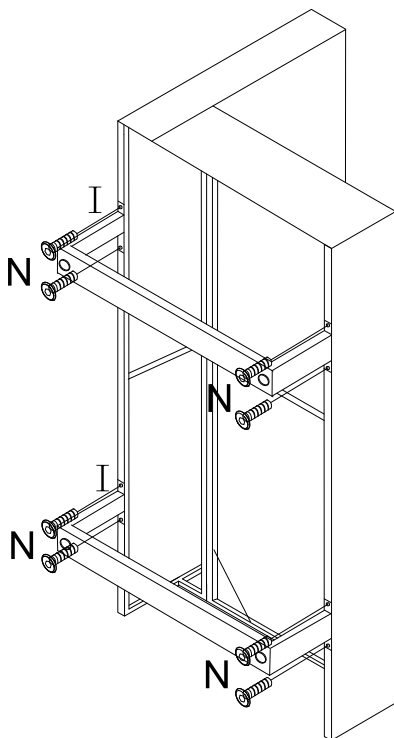

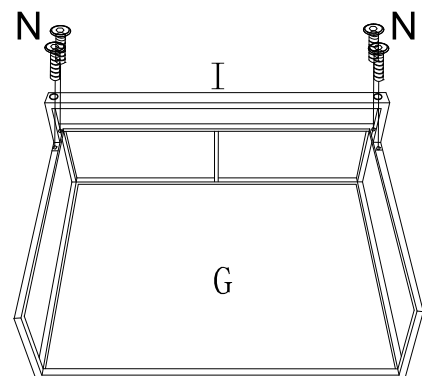

8

N	 M 6X16	4 pcs
---	---	-------

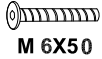

NOTE: 50% TIGHTEN BEFORE FIXING ALL BOLTS

9

O	 M 6X50	4 pcs
P		4 pcs
M	 M 6X35	1 pcs

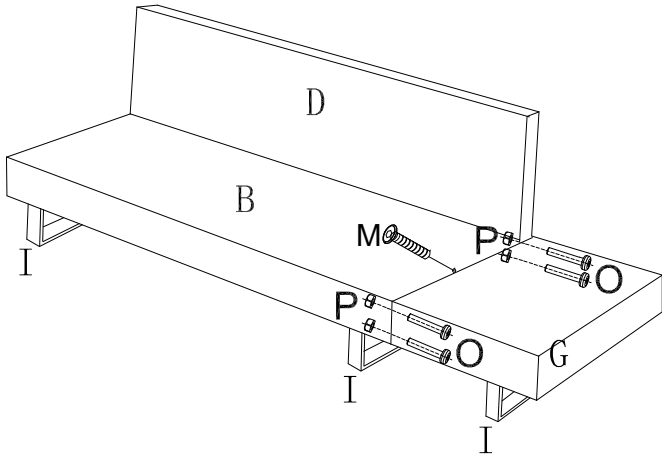

10

M	 M 6X35	8 pcs
---	---	-------

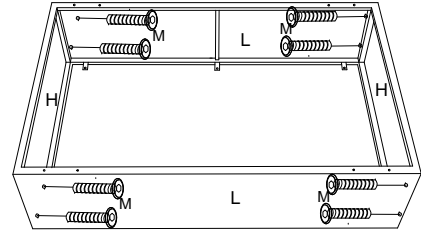

11

M	 M 6X35	4 pcs
---	---	-------

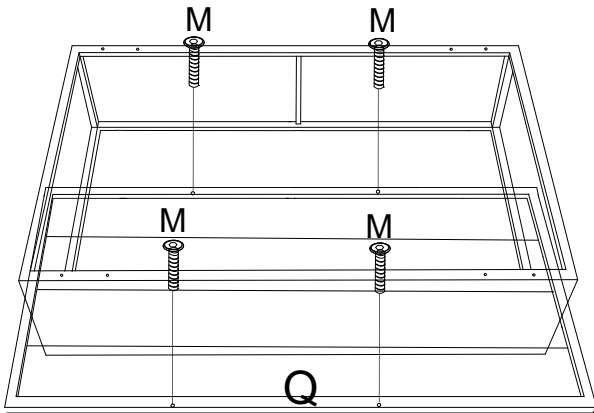

14

N	 M 6X16	8 pcs
---	---	-------

