



# MAYFAIR DAY BED

## ASSEMBLY INSTRUCTIONS

### **IMPORTANT:**

Please read this manual carefully before beginning assembly of this product. Keep this manual for future reference.

### **SAFETY INFORMATION:**

This item may contain small parts which can be swallowed by children and pets. Keep children and pets away whilst assembling. To avoid danger of suffocation, always keep plastic bags away from children and pets.

This product has been constructed to be used in the domestic environment only and not for commercial purposes.

Ensure that you have enough space to lay out all the components before assembly.

Assemble the item as close to its final position (within the same room) as possible.

To avoid scratching, marking or damaging the product it is recommended that you assemble it on a carpet or soft surface.

We do not recommend the use of power tools for assembly as this could damage the unit.

Assemble all parts, screws & bolts loosely during assembly. Only once the item is complete should you fully tighten the fixings.

The item can be assembled with one person but parts of the assembly maybe easier with the help of another person.

We recommend that the bed should be placed away from windows, blind cords, curtains pulls or other furniture if being used by a child.

Maximum recommended weight capacity of 150kg.





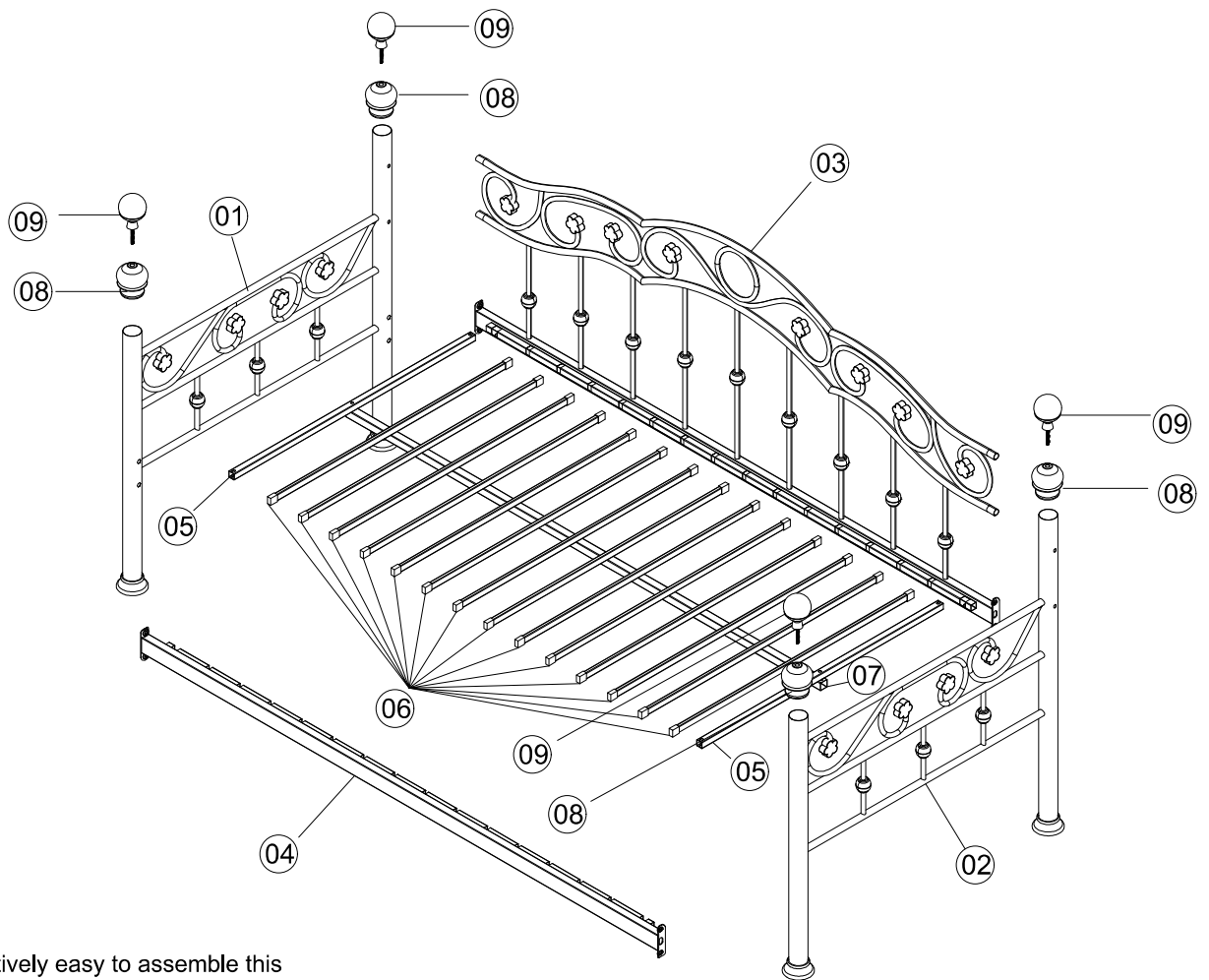
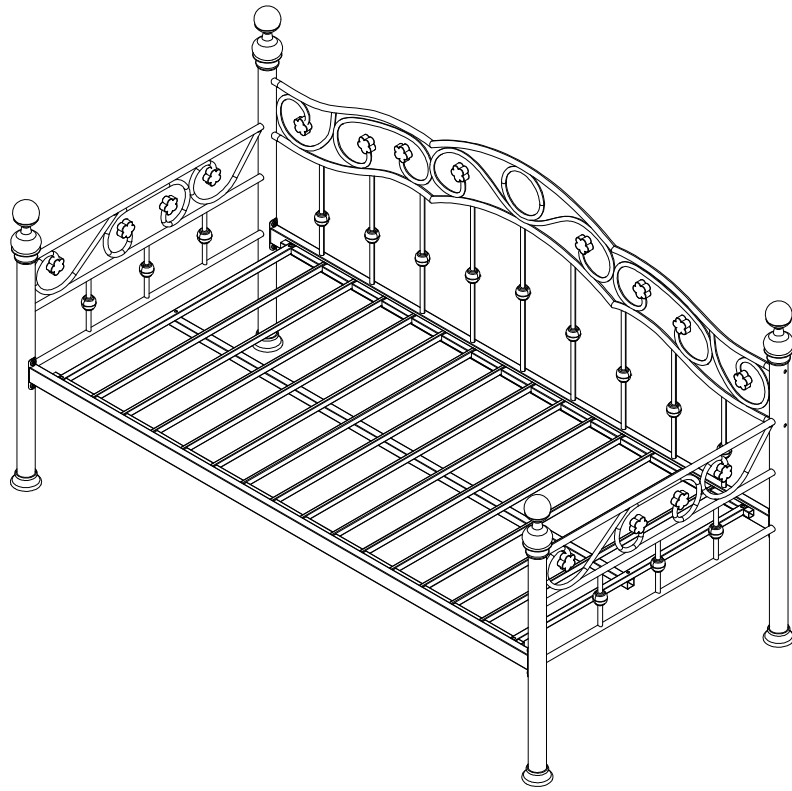

### **CARE & MAINTENANCE:**

Use only a dry cloth when cleaning the product. Furniture polish or anything containing chemicals that can react with the product are not advised.

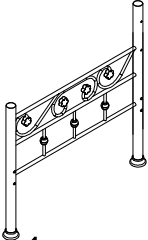
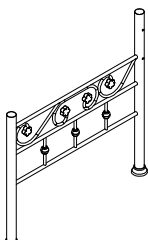
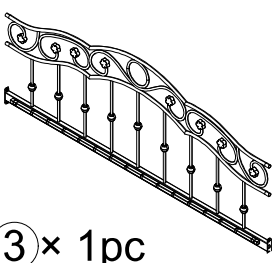
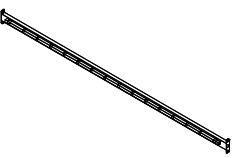
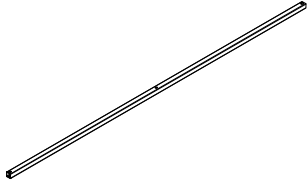
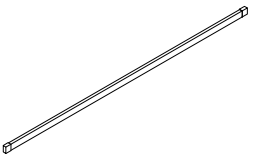
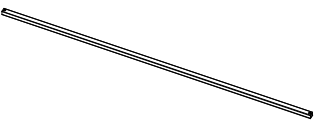
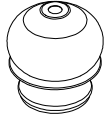
From time to time check that there are no loose screws, nuts or bolts. If there are then re-tighten.

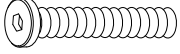
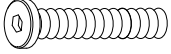

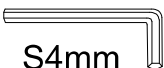
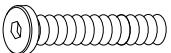
Whilst its relatively easy to assemble this bed with one person it is recommended that two people do this where required at certain stages of the build.

 <p>① × 1pc</p>	 <p>② × 1pc</p>	 <p>③ × 1pc</p>	 <p>④ × 1pc</p>
 <p>⑤ × 2pcs</p>	 <p>⑥ × 14pcs</p>	 <p>⑦ × 1pc</p>	 <p>⑧ × 4pcs</p>
 <p>⑨ × 4pcs</p>			
 <p>M8×20mm A × 8pcs</p>	 <p>M6×30mm B × 6pcs</p>	 <p>M6 C × 4pcs</p>	 <p>D-1 × 1pc S10mm</p>  <p>S4mm D × 1pc</p>
 <p>M6×65mm E × 4pcs</p>	 <p>F × 1pc</p>		

We recommend that all parts are laid out in advance of assembling the bed & to familiarise yourself with the items.

# 1



M8×20mm

A × 8pcs

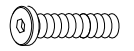

M8×65mm

E × 4pcs

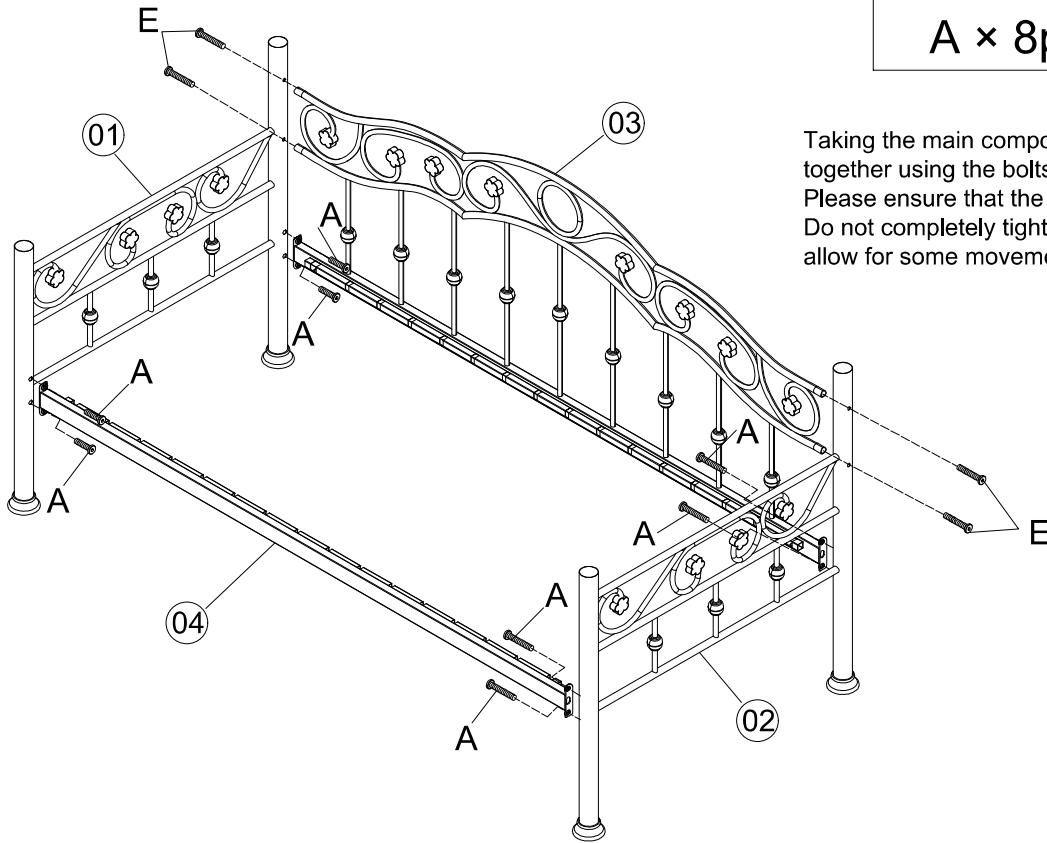

Taking the main components shown simply fasten together using the bolts and allen key provided. Please ensure that the correct size bolts are used. Do not completely tighten the bolts at this stage & allow for some movement.

# 2



M6×30mm

B × 4pcs



M6

C × 4pcs

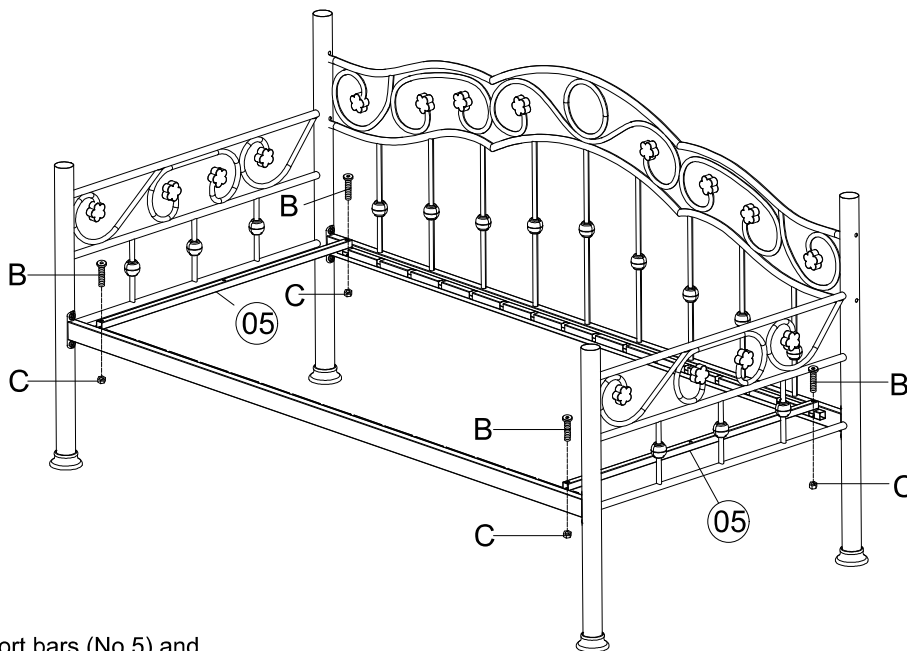

Locate the 2 x support bars (No 5) and screw these into place both ends of the day bed as shown. These can be screwed in tightly but avoid overtightening.

# 3

Attach the long centre bar using the correct bolts to the underside of the end support bars & tighten into place.



M6x30mm

B x 2pcs

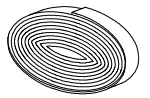

F x 1pc

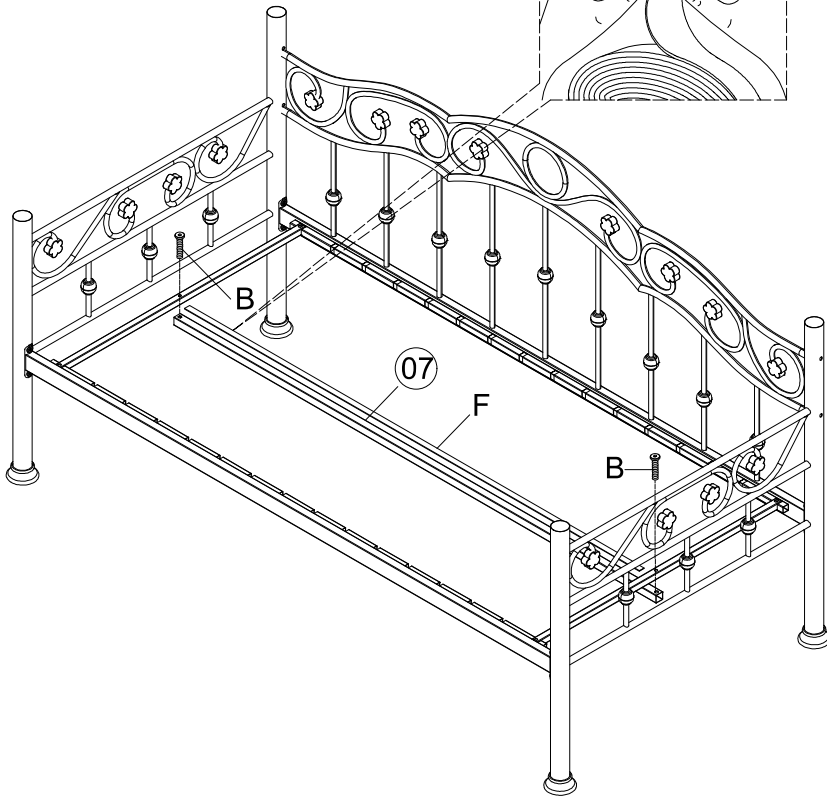
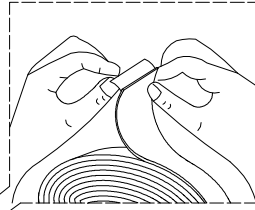

Carefully place the sticky foam tape down the length of the centre bar. The tape can be cut as required. The tape will help form a 'cushion' for when the slats are inserted in the next stage.

# 4

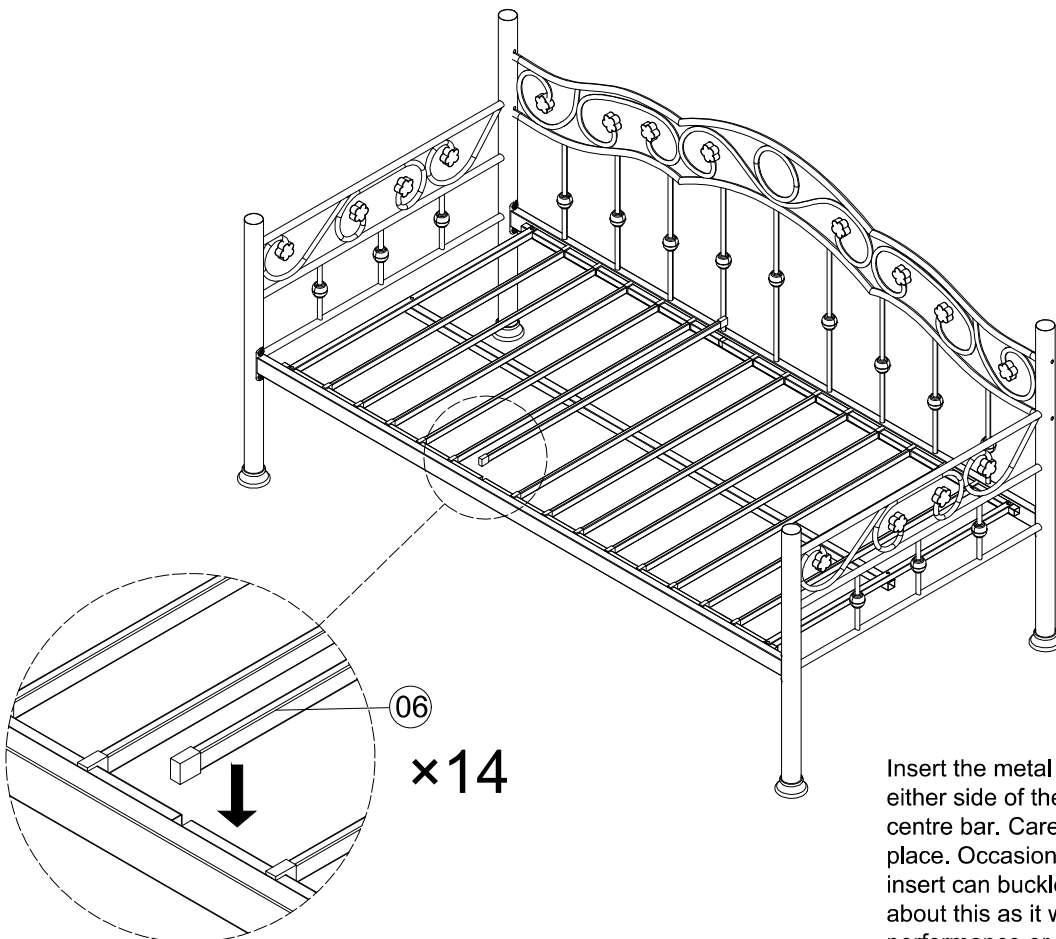

Insert the metal slats into the grooves either side of the day bed, across the centre bar. Carefully push them down into place. Occasionally & if forced the plastic insert can buckle slightly, don't worry about this as it will not effect the performance or structure of the bed.

# 5

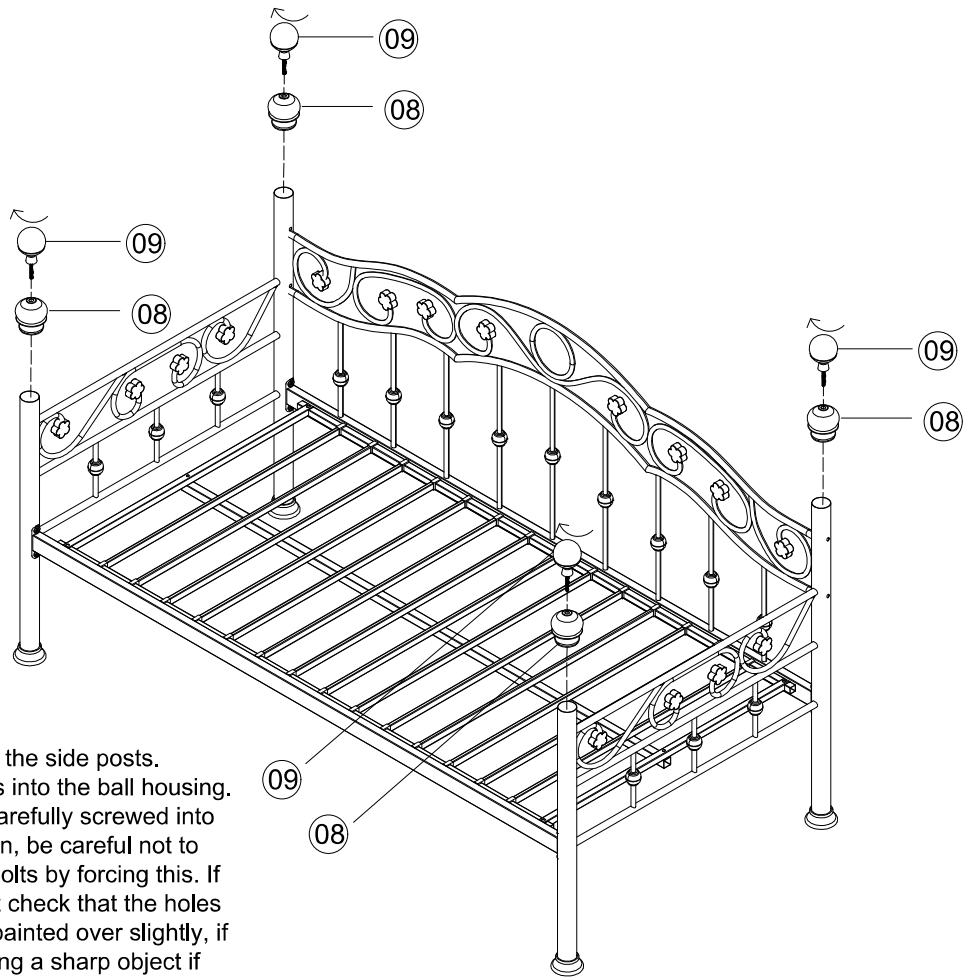

Attach the ball housings to the side posts. Finally, screw the end balls into the ball housing. Ensure that the balls are carefully screwed into place in the direction shown, be careful not to overtighten or 'thread' the bolts by forcing this. If there is any resistance just check that the holes or threads have not been painted over slightly, if so clear the threads by using a sharp object if required. As these are hand painted items this issue can occur occasionally.

Now completely tighten the bed frame together before use and move into its final position. From time to time just double check that all fixings are tightened. If being used on a wooden floor then it is recommended that sticky pads are used on the underside of the feet just to avoid any damage to the floor with movement of the bed (not supplied).