

WARNING: The weight of some of the products may be heavy. The installation may require two people.



IMPORTANT: Please follow these instructions carefully.

<p>1. Install the radiator at least 20 cm from the floor.</p>	<p>2. The minimum distance from the wall on the right must be at least 30 cm.</p>	<p>3. The minimum distance from the wall on the left must be at least 10 cm.</p>

IMPORTANT: Template measurements per model.

1. Drill the wall considering Lf and Hf as fixing holes according to the model purchased:

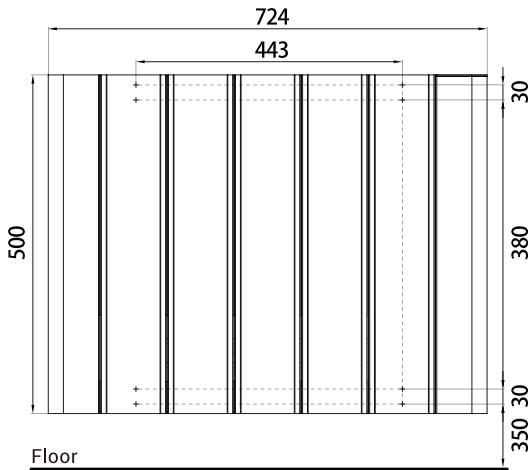

Mod. 1,000 W

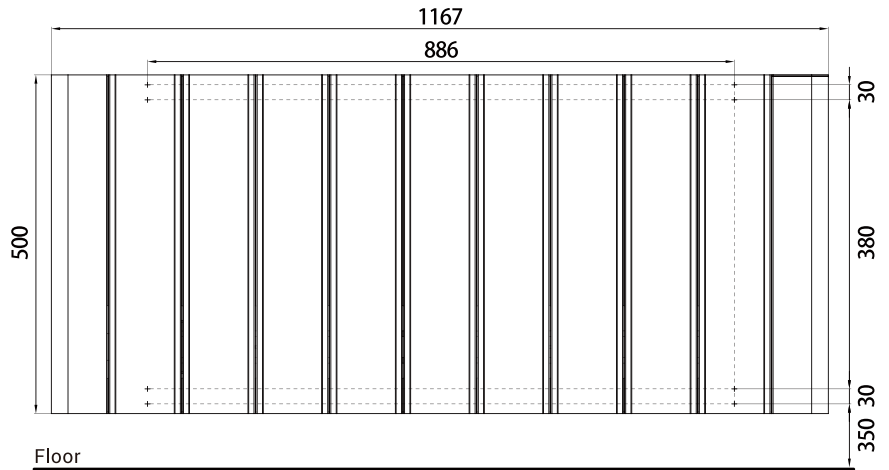

Mod. 2,000 W

2. After inserting the rawl plugs, install the 4 bracket guides (C in Diagram 2) supplied.

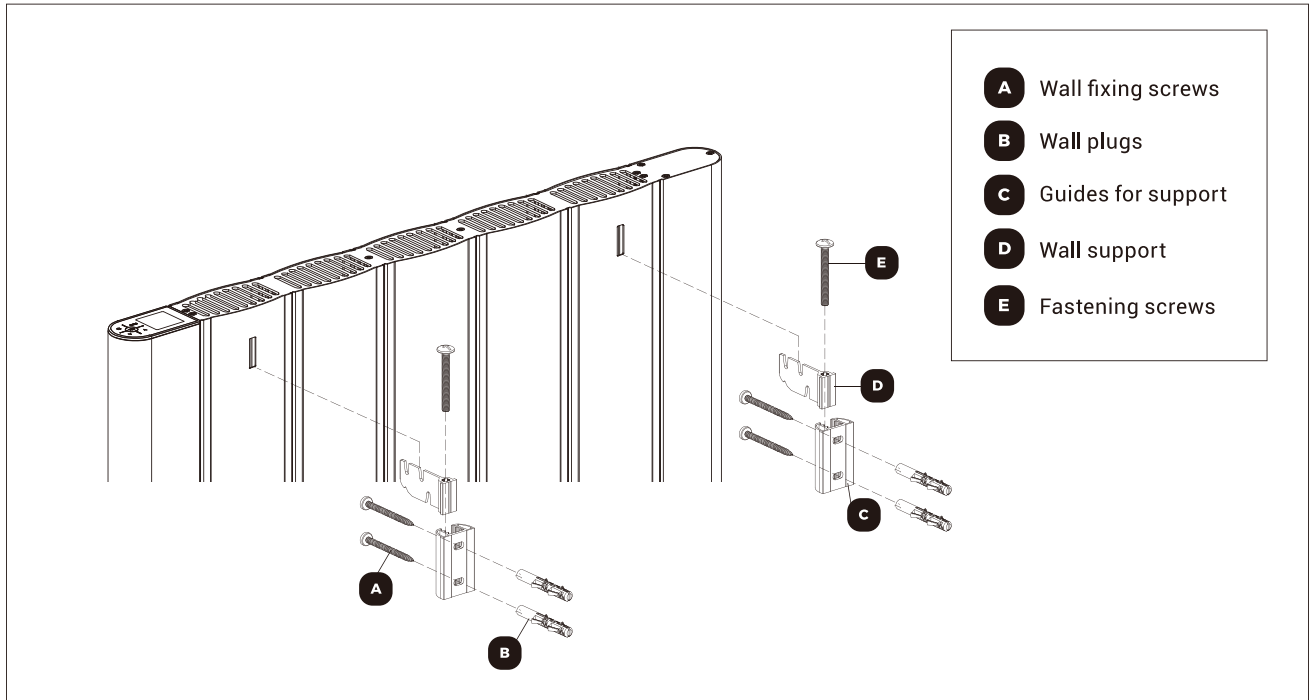

3. Insert the 2 upper wall brackets with the hook facing upwards and the lower wall brackets with the hook facing downwards , Mount the radiator on the 2 upper wall brackets. Then fit the radiator onto the 2 lower wall brackets and finish tightening the 4 fixing screws.

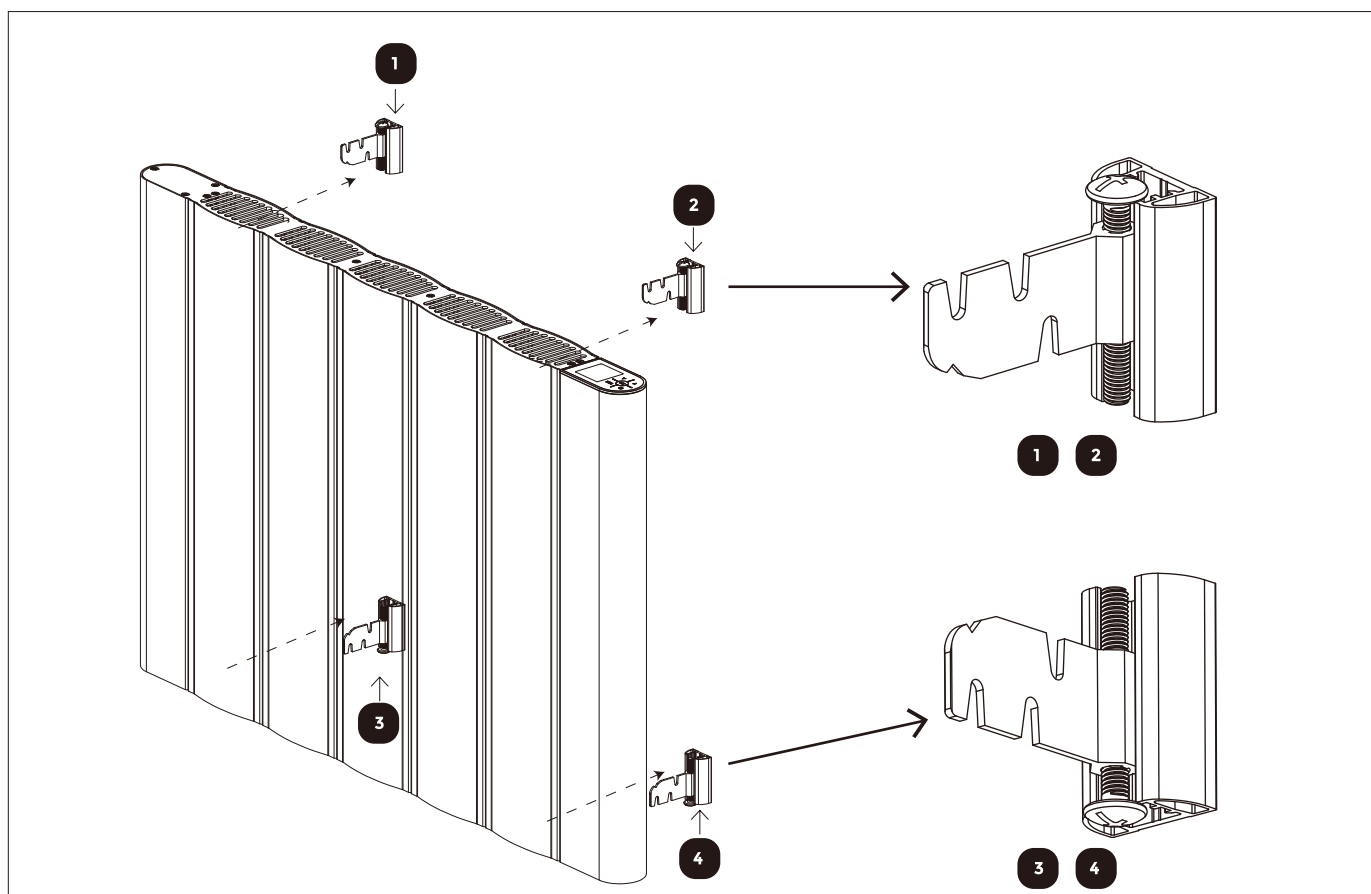

INSTALLATION AND SAFETY PRECAUTIONS (UNE-EN 60335 REGULATION)

Before starting the heater, read the "Installation and Safety Precautions" carefully to ensure proper operation of the heater.

PRECAUTIONS FOR INSTALLATION

The radiator is designed for domestic or residential use. We recommend that the radiator is installed by a distributor or an approved professional. Make sure that the heater is correctly connected to 220V-230V.

This appliance has been designed for installation in a residential room. The installation must be carried out in accordance with the standards in force in the country of installation (NFC 15100 for France).

The radiator must be directly connected to the mains after the omnipolar cut-off device with a contact opening distance of at least 3 mm without any intermediate switch (clock, mechanical and static relay, room thermostat, etc.).

AF32 operation instructions

1. Panel display:



2. Technical Features:

Voltage	220~240V AC / 50~60Hz
Power	Max 2000W
Operating temperature range	-10~40°C
Setting Temperature	7~30°C
IP rating	IP20
Appliance Rating:	Class 1
System Mode	Comfort Mode, Economy Mode, Weekly Program, Antifreeze mode, Boost Mode, LST Mode, Holiday Mode, Window Opening function

3. Display and button description:

3. 1. Display icon description

Comfort Mode	Economy Mode	Antifreeze Mode	Boost Mode	LST Mode
			PROG	
Holiday Mode	Window opening detection function	Heating State	Weekly Program	Child lock
	88.8 °C	88:88	1234567	ROOM
Wireless icon Long light when connected Flashes when not connected	Temperature display	Date and time display	Week display	Room temperature Live temperature
SET		 0h 2 4 6 8 10 12 14 16 18 20 22 24		
Setting temperature		Daily running time setting		

3.2. Button instruction

	OK	PROG		
On/Standby button	Setting button	Weekly program button	+ button	- button

4. Operating Instructions

- 4.1. **Power-on state:** Power into the standby state, display the time and week, the first power-on time is 12:00 on Monday, shown as



- 4.2. The manual setting operation of the time and date is as follows (the device time is automatically synchronized to the network time after networking) :

4. 2. 1. **Year adjustment:** In the standby state, long press **OK** button for 3S, the year flashes, short press ▲ or ▼ to adjust, the adjustment range is 2024~2099, step forward 1, long press has the acceleration function, shown as

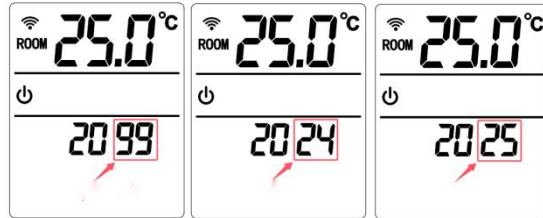

When it shows 2024, short press ▲ to jump to 2025.

When it shows 2024, short press ▼ to jump to 2099.

4.2.2. **Month adjustment:** Short press **OK** button, the month flashes, short press ▲ or ▼ to adjust, the adjustment range is 1~12, step forward 1, long press has the acceleration function, shown as

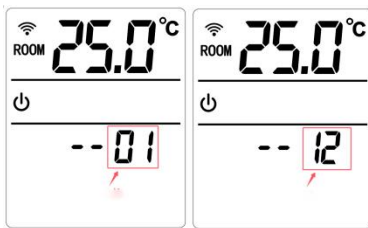

4.2.3. **Date adjustment:** Short press **OK** button, the date flashes, short press ▲ or ▼ to adjust, the adjustment range is 1~31, step forward 1H, long press has the acceleration function, shown as

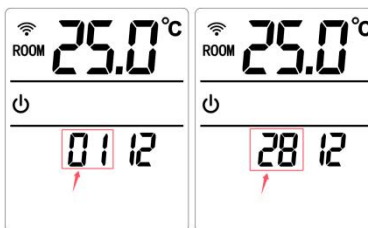

4. 2. 4. **Hour adjustment:** Short press **OK** button, the hour flashes, short press ▲ or ▼ to adjust, the adjustment range is 0~23, step forward 1H, long press has the acceleration function, shown as



4. 2. 5. **Minute adjustment:** Short press **OK** button, the minute flashes, short press ▲ or ▼ to adjust, the adjustment range is 0~59, step forward 1 min, long press has the acceleration function, shown as



4.2.6. **Week adjustment:** Short press **OK** button, the week flashes, short press ▲ or ▼ to adjust, the adjustment range is 1~7, step forward 1 day, shown as below, you can do recyclable setting.



4.3. **Power-on state:** Short press ⏻ to enter the last working mode, shown as



5. **Mode switch:** In Power-on state, short press **OK** to switch mode default order: comfort mode → economy mode → antifreeze mode → Boost mode → LST mode → holiday mode → comfort mode, cycle in turn, remember the current operating mode and settings.

When short press ⏻ to shutdown or re-power after power off, both states will be back to the last running mode. In any mode, short press **PROG** will directly start the weekly program.

5.1. **Comfort mode** ☀️ : The adjustable range is 7~30°C, the default temperature is 19°C for the first time, and the subsequent temperature is the temperature which you set last



time, shown as , short press ▲ or ▼ to set the temperature, step forward 0.5°C. Long press has the acceleration function.

When the setting is complete, the temperature displays the indoor temperature, shown as





5.1.1. **Heating work:** when it is heating, the icon is long light, shown as  .

When it is not heating, the heating icon is not displayed.

5.2. Economy Mode  : The default temperature is 15°C, the adjustment range is 7~30°C, shown as



Short press  or  to set the temperature, step forward 0.5°C, long press has the acceleration function. The setting temperature cannot be higher than the comfort temperature.

When the setting is complete, the temperature displays the indoor temperature, shown as



5.2.1. **Heating work:** when it is heating, the icon is long light, shown as  .

When it is not heating, the heating icon is not displayed.

5. 3. **Weekly program (PROG)** : Power on for the first time, the default time is 12:00 on Monday, run on economy mode, shown as



The icons at the bottom are time track, each small square represents 1 hour.

The icon  represents this period runs on Comfort Mode.

The icon  represents this period runs on Economy Mode.

5.3.1. The initial default setting is that it runs on Comfort Mode from 5: 00 to 23: 59 and it runs on Economy Mode from 00: 00 to 04: 59 for everyday, shown as



5.3.2. The operation of check every hour of every day of the week: in the running state, long press **PROG** button for 3S to enter the setting interface of week 1-7, the default setting starts from Monday each time, short press ▲ or ▼ to switch the week at will.

5.3.3. The operation of modify every hour of every day of the week: in the view state, long press

PROG button for 3S, the time track hour 0 (00:00-00:59). The icon flashes as



There are two settings at this moment:

The first setting: short press ▲ button to set the hour 0 into comfort mode, the hour and icon automatically jump to hour 1, shown as



The second setting: Short press ▼ button to set hour 0 into economy mode, the hour and icon automatically jump to hour 1, shown as



When you finish modification, it shows



After setting the hour 23, it automatically jumps to hour 0 and so on. After setting, short press **OK** button to confirm, exit and return to **PROG** button and select settings interface, shown as





5.3.4. The operation of exit the setting:

5.3.4.1. After setting week 7 according to 5.3.3 setting steps, short press **OK** will automatically exit the setting interface;

5.3.4.2. In the setting interface, no button operation for more than 15 seconds will automatically exit from the setting interface;

5.3.4.3. In any setting interface, short press  button to shut down the device and save the modified data before shutdown. After the above settings are completed, the radiator will start to work after 3 seconds of no operation with the prompt tone "Di".

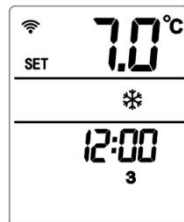

5.4. **Antifreeze mode**  : short press **OK** button to switch to  button, in antifreeze mode, the temperature is fixed at 7 °C, the temperature can't be adjusted. When the ambient temperature probe detects that the indoor temperature is below 7 °C, the radiator will start to work. The radiator will stop heating when the room temperature rises to 7 °C, which can avoid any frost risk. We recommend using this mode when there are no people at home for a long





period of time (e.g. holidays), shown as

5.4.1. **Heating work:** when it is heating, the icon is long light, shown as  .

When it is not heating, the heating icon is not displayed.

5.5. **Boost mode**  : In any other mode, short press **OK** button to switch to  button, heating at 35°C as the setting temperature, the adjustment range is 0:15-24h with 15 minutes as a step, the initial default is 15 minutes, after modification, it will remember the current setting





time, short press  or  to add or subtract the time, shown as

when it is heating, the icon is long light, shown as  .

When it is not heating, the heating icon is not displayed.

When the countdown ends, it will exit BOOST mode and return to the previous entry mode.

5.6. **LTS mode**  : Short press **OK** button to switch to  button, the temperature range is 40-55 ° C with 5° C as a step (40/45/50/55 ° C) ,shown as

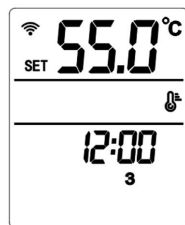
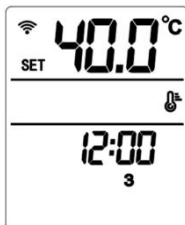

5.6.1. LTS mode refers to the radiator surface temperature is controlled at 40-55 ° C. It is touched very safely, it is suitable for schools, nurseries, hospitals and nursing homes, LCD shows the setting temperature:

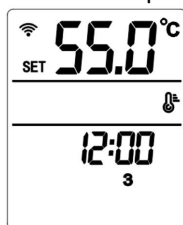

5. 7. **Holiday mode**  : short press **OK** button to switch to  button, LCD shows



5.7.1. Long press **OK** button, then short press **▲** or **▼** button to set the end date of holiday mode. Short press **OK** button to confirm the setting of the end date of holiday.

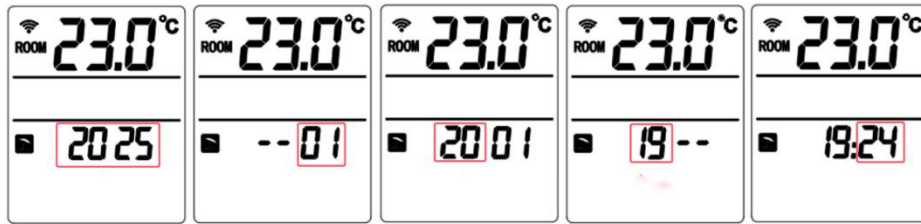

It takes 0.5 seconds to flash once for the above numbers which correspond with the year, month, day, hour, and minute during setting.

5.7.2. Short press **▲** or **▼** button to set the required temperature, temperature range: 7-15 ° C with 0.5 ° C as a step, after setting the temperature with 3 seconds' no operation, it will start to run on the holiday mode, when the holiday mode ends, it will return to standby mode, shown as (After setting the holiday mode and switch to other modes, then switch back to the holiday mode. The setting time and temperature will remember the data before the switch, no need to reset it.)



5.8. **Child lock** : In standby mode and power on working mode, long press **▲** or **▼** for 3 seconds at the same time to enable the child lock function, shown as



Note: In the child lock state of working mode, short press  button is turned off.

In addition, other buttons cannot be operated in any mode, which includes long press or short press  button are both invalid in standby mode of child lock state.

5.8.1. **Unlock the child lock** : Long press ▲ or ▼ for 3 seconds to unlock the child lock, when exit the child lock state, all buttons can be operated again.

6. Internal parameter setting:

6. 1. **Window opening function** 

6.1.1. **Description of window opening function:** In the heating state, when the ambient temperature suddenly drops by 5 ° C within five minutes, the radiator enters the starting window opening mode, the radiator enters the fixed temperature 10 ° C mode, after heating for 60 minutes, the radiator will return to the working mode which is before opening the window. If the temperature drops 5°C again within 5 minutes, then the radiator will enter the fixed temperature 10°C mode to heat for 60 minutes, and so on in

a cycle, shown as .

6. 1. 2. In standby state, long press ▼ button for 3 seconds to enter the setting, there are three options "OF", "60" and "90" (the default is "OF"), when the user sets "60", shown

as .

6.1.3. **Setting operation instructions:** short press ▲ or ▼ to switch to OF→60→90,

setting "OF" means that the function is not enabled, setting "60" and "90"

means that the window opening mode is started, this function will be started only in the working mode, this function will not be started in the standby state. The display in the working mode:

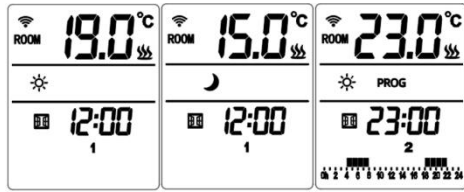

6.2. **Ambient Temperature Compensation tc:** In the standby state, long press ▲ for 3 seconds to enter the ambient temperature Compensation tc setting .

6.2.1. Setting operation: short press ▲ or ▼ to add or subtract the temperature, the adjustment range is $-8\sim 8^{\circ}\text{C}$ with 1°C as a step. The default is -2°C , it can be set by cycle, shown as



6. 2. 2. Ambient temperature compensation function description: the factory default setting is -2°C . When the user sets the comfort temperature as 25°C , when the ambient temperature around the radiator is at 23°C , the radiator will stop working. At this time, the ambient temperature compensation can be set to -4°C .

7. **Power failure memory function:**

In case of sudden power failure, the working state is locked at the moment of power failure. The setting state before power failure will be automatically restored after the call. Other Settings do not need to be reset except the time.

8. Restore factory settings:

In the case of power, long press ⏻ for 5 seconds, the system will automatically restore factory settings. Full screen display for 2 seconds, it will enter the shutdown state, then short press ⏻ to power on. It displays comfort temperature 19°C , economy temperature 15°C . The time displays "12:00" , the week displays "1", the ambient temperature compensation displays "-2", the window opening function displays "OF".

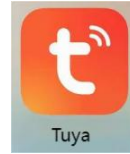

9. Connect to the Internet: Download and install the Doodle Smart App



Life from APP Store (Android) or App Store (IOS), follow the instructions in the app to create an account number.

9.1. Before connecting to the Internet, please complete steps a and b:

a. Connect the mobile phone to WiFi (the device only supports 2.4G WiFi) and turn on Bluetooth;

b. In order to speed up the pairing with the mobile phone, the thermostat supports automatic discovery of nearby devices before it is connected to the Internet. Once you open the homepage of the Doodle app, it will automatically search for the thermostat to be paired. If the app does not automatically find the thermostat or it needs to be connected to the Internet again for pairing operation: please long press  button for 5 seconds in comfort mode state, the

device will enter the state to be allocated to the network, the device will start the countdown for



99 seconds, shown as

9.2. Open the "Doodle Smart" APP, "Add Device" → "Automatically Discover Device" →

"Click And Add", shown as:

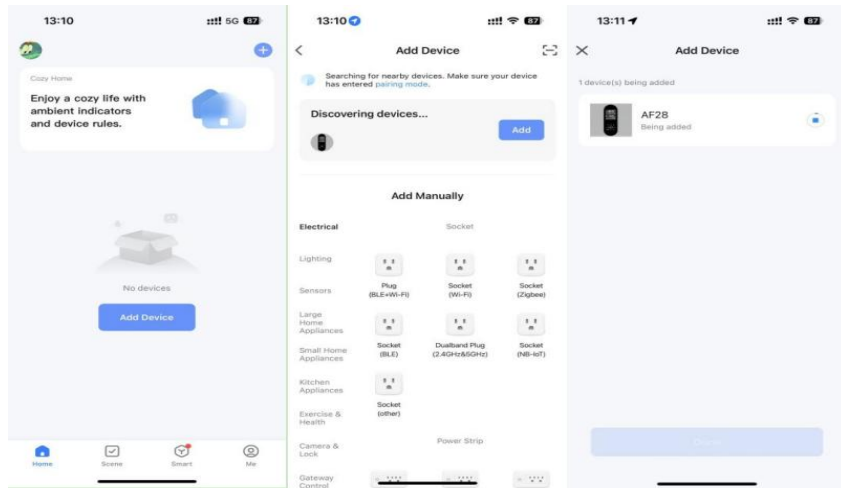

9.3. Input the connected "WiFi password" and click "Next" → "Add Completed" → "APP control page", shown as

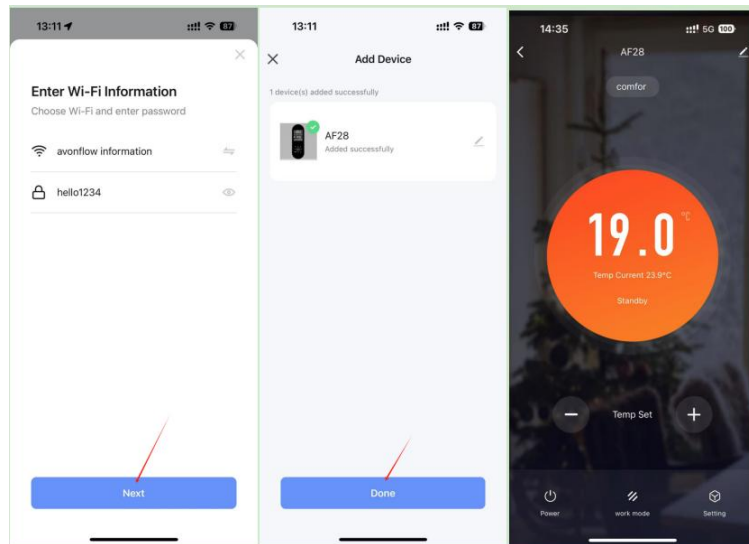

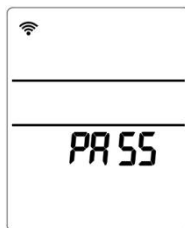

9.4. When connects to the network successfully, the LCD screen is displayed as



, After 3 seconds of display, the screen will turn off and enter the shutdown state.

When connects to the network successfully, the icon  on the screen is always bright in both shutdown and working state.



9.5. When connects to network unsuccessfully, shown as  . After 3 seconds of display, the screen will turn off and enter the shutdown state. In the case of unsuccessful network distribution or no network distribution, the icon  on the screen flashes no matter in the shutdown or working state.

9.6. week program "PROG" in the App:

9.6.1. You can switch to the weekly program from the "Doodle Smart" APP of mobile or thermostat panel.

When it is in weekly program state, the radiator is heated at the setting temperature of comfort mode and economy mode. A 24-hour timing heating period can be set in the APP.



9.6.2. After switch to the weekly timing mode in the App, the device will run according to the default setting. If you need to modify the weekly program, you should modify it in the "Weekly Program Setting" in the mobile app after the device is connected to the Internet.

9.6.3. Weekly program setting: The default program setting of the mobile APP, shown as



if you want to set the corresponding time period, you can tap the corresponding time period to change the color. (Green bar) indicates that the time period is running in comfort mode, (blue bar) indicates that the time period is running in economy mode.

10. Exception code description:

Phenomena	Instructions	Shown as
Open or short circuit of ambient temperature sensor	Temperature display Er1	
Open or short circuit Of frame temperature sensor	Temperature display Er2	

11. The record sheet of modification

NO.	Content Change	Time of change
1	Version 1 Release	2024/07/31
2	Added Year Setting	2024/10/14
3	Version 2 Release	2024/10/23
4	Version 3 Release	2025/2/28