



# Installation instructions Decking systems

Greener living with bamboo



[www.amboo.com](http://www.amboo.com)

## DECKING BOARDS ASSEMBLY INSTRUCTIONS

### Notes:

For stable and durable bamboo decking, a professionally executed substructure is of great importance. A substructure facilitates wood protection by creating a gap between the ground and the floor covering. The following specifications and instructions, including the care instructions at the end, apply to all types of installation of aMbooo® decking.

### Substrate

The nature of the ground is very important for stable and durable decking and must be carefully prepared in advance. For a professionally executed decking construction, a load-bearing substrate of soil, gravel, gravel, concrete foundations, old stone decking or floor slabs is a prerequisite. The decking load is borne by the ground.

- A supporting substrate is a basic prerequisite for aMbooo® decking. Loose substrate such as gravel and sand is not permitted and appropriate preparations must be made.
- We recommend excavation if you want to place the decking on the ground. This can be filled with gravel that then has to be compressed.
- The substrate must be permeable to water. Standing water under the decking must be avoided.
- A root mat provides additional protection.
- 30 x 30 cm concrete slabs can serve as a base for the feet, as they ideally distribute the load.

This applies both to the use of pedestals and when using rubber pads. The choice of substructure, aMbooo® bamboo or aluminium profiles, is independent of this. For the screw connections we recommend the use of stainless-steel bits. Abrasion of conventional bits can cause stains to the surface, as they are not corrosion resistant.

### Initial care and maintenance care

aMbooo® decking is pre-oiled twice at the factory. For optimal weather protection, the surface must be first treated with the appropriate aMbooo® bamboo care oil after installation. Failing to do so leaves the surface insufficiently protected against the effects of the weather and results in more pronounced changes in the natural materials. Please observe the recommended application quantity for the aMbooo® bamboo care oil and stir the container well before use. The instructions on the container and on the product data sheet must be heeded. Applying too much can lead to thick layers forming and hence problems with the drying of the care oil. It is best to practice on a test piece or what will be an underside. Any excess oil applied must be removed before drying. Even before assembly, we recommend treating the groove on the head side of the plank with aMbooo® end-edge wax.

The decking must be oiled once every spring to maintain its longevity. In highly stressed areas such as pools, by the sea, high UV radiation, in the mountains and regions with high snowfall, shorter maintenance intervals are required. If you separate the decking by length or width, the cut edges must first be oiled and then treated with our aMbooo® end-edge wax.

### Rear ventilation and spacing

It must also be ensured that decking can be ventilated from the sides. Rear ventilation can be ensured by mounting in combination with air inlets such as drains, grilles or other design solutions. For roof decking, a minimum distance of 2 cm from the parapet must be observed. The 2 cm also apply to the distance to lawns, lawn edge stones, building walls and all other permanently mounted components/ structures. If the parapet protrudes more than 10 cm above the decking, additional ventilation through drains or similar must be ensured. A complete closure is not permitted. Waterlogging and a lack of rear ventilation can lead to irreparable damage.

### Drainage

A slope of at least 1-2% is required for optimised drainage of the decking surface. aMbooo® drainage boards can be used for this. Other solutions must be implemented on site. Drainage must be used for doors or floor-to-ceiling windows.

### Installation of balconies / roof decking

aMbooo® decking can also be used for balconies and roof decking. Wind suction loads must be taken into account when designing the substructure. Guidance is provided in Eurocode 1: Impacts on load-bearing structures according to DIN EN 1991-1-4 or in BFS leaflet No. 18 „Coatings on wood and wood-based materials in outdoor areas“. In principle, roof decking and balconies must be calculated by a structural designer or engineer. Every installation has different performance requirements, for which the implementing company is responsible. Depending on the specifications, it may necessary to work with supports or connections to the floor. The technical solution is to be provided by the processor.

### Dimensions and specifications

When mounting aluminium substructures, sufficient distance to walls or other enclosing restrictions must be observed, as aluminium can expand by 1 cm per 10 m length, when temperatures rise. The plank may not extend by more than 5 cm beyond the substructure. The substructure may not exceed more than 5-fold of the distance of the substructure from the last support point. The maximum distance between the stiffeners is 1.5 m. In the next field, the bracing is shifted by a factor of 0.5 to the previous field. Decking planks must always be mounted longitudinally/ parallel to the house wall. They may not be laid transversely / perpendicularly to the house wall.

### Tools

The use of metal drills and carbide-tipped circular saw blades is recommended for processing aMbooo® boards. This prevents cracks from forming.

**The care instructions for aMbooo® decking must be observed. Failure to observe or deviating from specifications and recommendations for installation and maintenance of aMbooo® decking reduces the service life of the decking and voids the warranty.**

Further information and ideas for our decking boards, system fences and facade boards as well as installation and care instructions can be found here:

on Internet:



[www.ambooo.com](http://www.ambooo.com)

on Instagram:



[ambooo.de](https://www.instagram.com/ambooo.de)

on YouTube:



[aMbooo international](https://www.youtube.com/channel/UC...)

## DECKING BOARDS ASSEMBLY INSTRUCTIONS

### Bamboo substructure

#### Brief description :

The 40 x 40 mm cross-section of the bamboo substructure ensures high stability and corresponds to the usual dimensions for this type of use. The system is installed floating, without anchoring to the floor or a wall.

The bamboo substructure slats are untreated, which may cause mould to form. We recommend oiling the substructure before installation especially if the bamboo substructure slats are mounted in a visible area.

#### Installation with pedestals:

In the first step, the floor must be prepared for the pedestals. Then the feet with the profiles are positioned. The centre distance of the profiles is 400 mm and the distance between the feet is 50 cm. Depending on the load, a smaller distance is required.

The bamboo substructure is fastened to the pedestals with a screw through the L-adapter on the pedestal. The profiles are connected with a cross brace every 1.5 m. For this you need 2 30 x 30 x 20 mm stainless steel angles with 2 screws each. These are attached diagonally offset to the cross brace. In the area of plank joints, a double substructure must be installed.

The UK can be extended by using our connector. It is important that the connector is fixed with 4 screws, which are staggered. This is necessary so that the screws do not meet in the profile. Place the connector from the side next to the connection. Now it can be screwed. Use a 4.5 x 35 mm screw. The connection must be supported with a pedestal, rubber pad,... to prevent deflection. The connection must be supported. The cut edges must be treated with our aMbooo® end-edge wax.

For assembling the boards, the starter clip is first mounted on the head sides of the substructure. The first plank can then be inserted. Now the surface clips can be inserted into the plank and screwed. The second plank can then be inserted. This process is carried out to the end. If original aMbooo® Univeseal clips are not used, we recommend pre-drilling the substructure with a diameter of 3 mm for all other kinds of clips.

The last plank is fixed with the aMbooo® end clip. For this, the plank must extend 25 mm beyond the substructure. Alternatively, the last plank can be visibly screwed onto the substructure. The use of clamps with protective jaws is recommended.

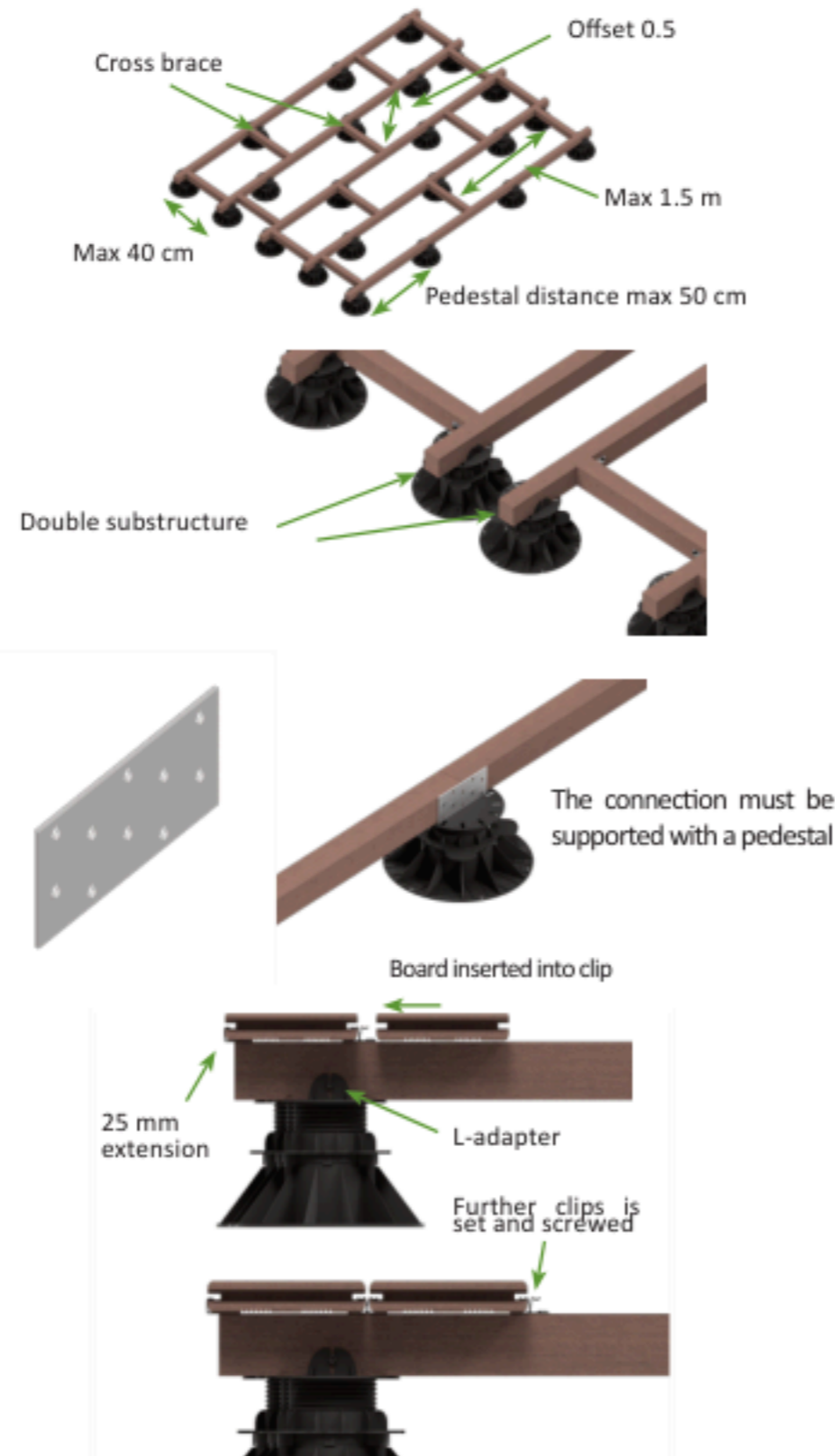

#### Assembly without pedestal:

The bamboo substructure can also be used without pedestals. In this case, pavement slabs with 50 cm spacing, starting from the centre of the slab, can be used as a base. To increase the service life of the substructure, a separation layer between the substructure and the plate should be used. For this, aMbooo® rubber pads are used.

For this type of installation, we recommend building a frame to achieve the necessary stability. A cross brace is then no longer necessary. 30 x 30 x 20 mm stainless steel angles can be used for connection to the frame. Any other on-site solution is also suitable. In addition, it is recommended to anchor the substructure either to the building wall or the ground with at least two points. For this purpose, it is advisable to use angles as piercing the substructure is not recommended. If the decking is enclosed, this is not absolutely necessary.

To assemble the boards, first mount the starter clip on the head side of the substructure and then insert the first plank.

Now the surface clips can be inserted into the plank and screwed. Subsequently, the second plank is pushed into the clip as in the installation with pedestals. The use of clamps with protective jaws is recommended. Repeat this process to the end.

The last plank is fixed with the aMbooo® end clip, which requires the plank to extend 25 mm beyond the substructure. Alternatively, the last plank can be visibly screwed onto the substructure. The use of clamps with protective jaws is recommended.

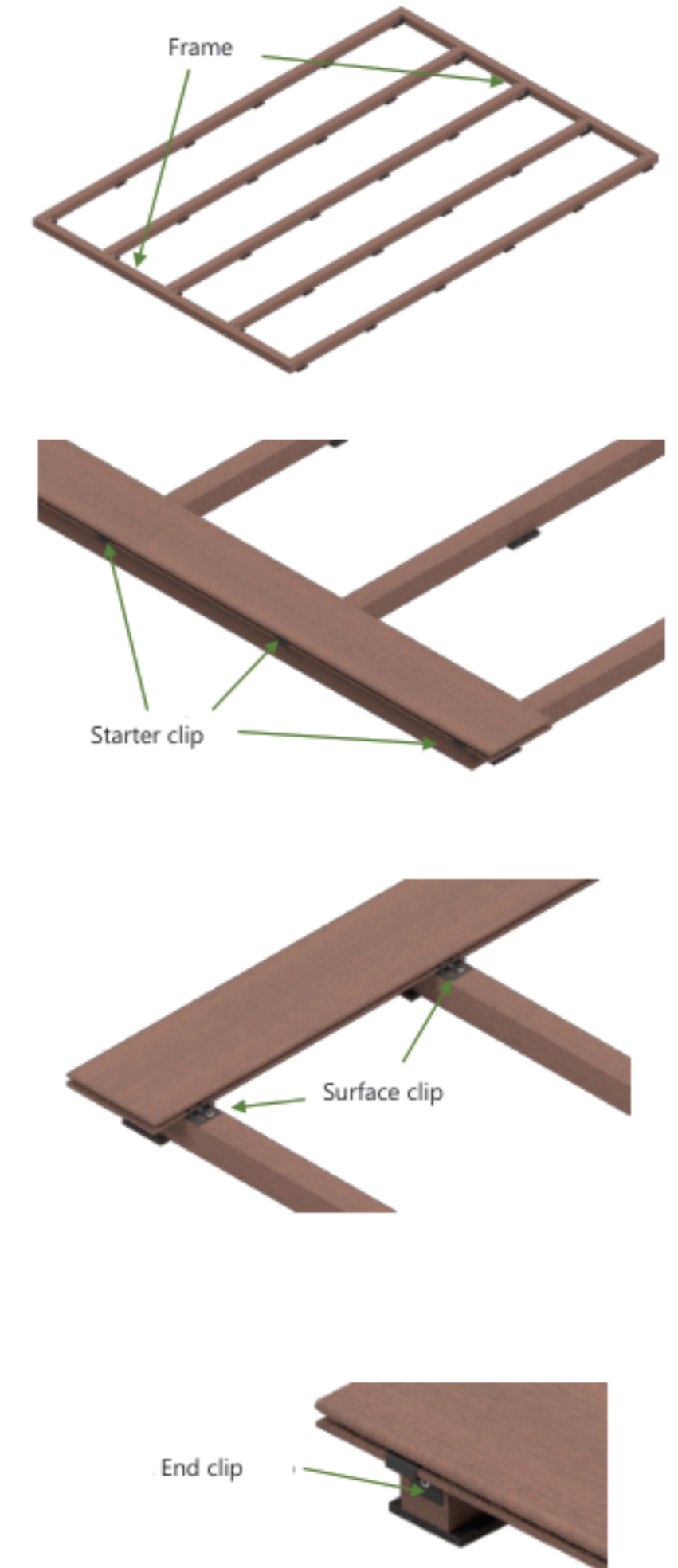

## DECKING BOARDS ASSEMBLY INSTRUCTIONS

### Bamboo with direct screw connections:

Decking can also be screwed directly to the aMbooo® Bamboo substructure. This is possible with rubber pads both with pedestals and without. To do this, align the first plank to the wall of the house and ensure sufficient rear ventilation (2 cm minimum). The first board will determine how the other boards lie; therefore, this must be done accurately. Now the board can be screwed into place. With coarsely grooved planks, do not screw in the lowest part of the groove.

For the screwing itself, the plank and the substructure must be pre-drilled with at least the outside diameter of the screw and the substructure pre-drilled with the core diameter of the screw. Use an A2 5 x 55 mm screw. A distance has to be created between the board and the substructure, for which aMbooo® rubber pads or special spacers can be used. Use 2 screws per fixing point. The distance from the outer edge of the plank to the screw must be at least 2.5 cm.

The UK can be extended by using our connector. It is important that the connector is fixed with 4 screws, which are staggered. This is necessary so that the screws do not meet in the profile. Place the connector from the side next to the connection. Now it can be screwed. Use a 4.5 x 35 mm screw. The connection must be supported with a pedestal, rubber pad,... to prevent deflection. The cut edges must be treated with our aMbooo® end-edge wax.

The second plank is aligned with the first. For this purpose, spacer blocks or spacer crosses can be used. A distance of 6 mm or more is ideal, which can be achieved by placing spacers on the first board and pushing the second board to the blocks. In this method, the plank including the blocks is fixed with a clamp with protective jaws. Now the board can be screwed. Repeat until the end.

A double substructure must be used for joints. A cross brace or frame is not necessary.

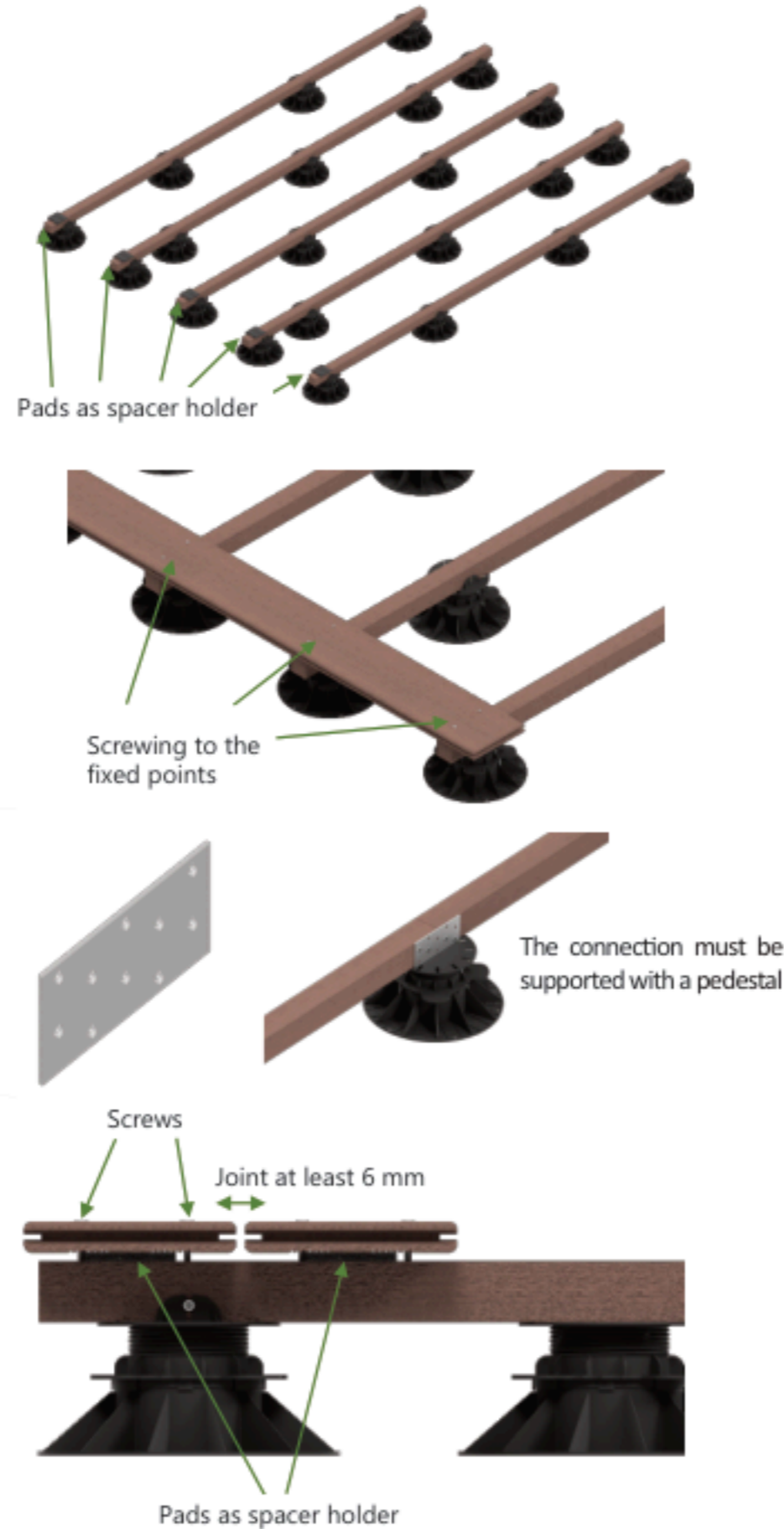

### Installation with aMbooo® Universeal Clip:

Start assembly by inserting the clip into the groove. The flexible arm holds the clip in the groove without tipping over. It also prevents falling out. The clips are positioned along the board to match the substructure.

In the second step, the next plank is placed on the other side and pushed to the clip. It is sufficient to press the plank firmly against the clip. If excess force is used, for example with screw clamps, the screw could damage the plank.

When the second plank is abutted, it can be screwed in position. We recommend using stainless steel long bits. When screwing, apply back pressure to the second plank to prevent it from slipping.

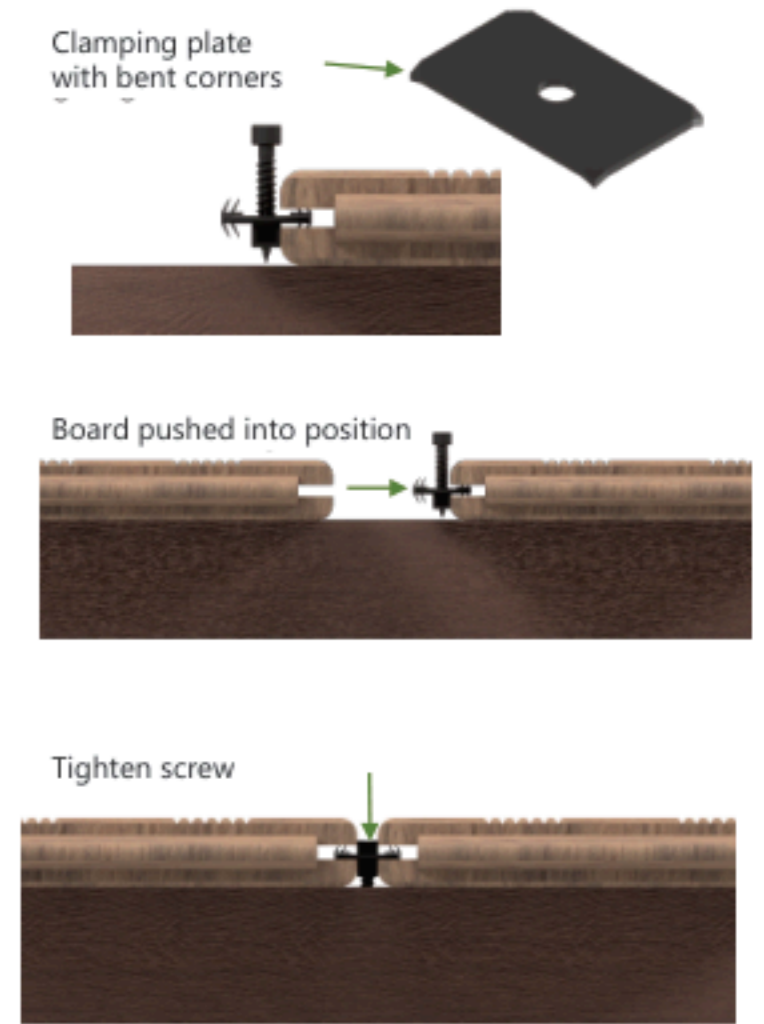

Useful accessories and other material for your decking can be found in our catalogue.

#### Drainage + ventilation element for decking

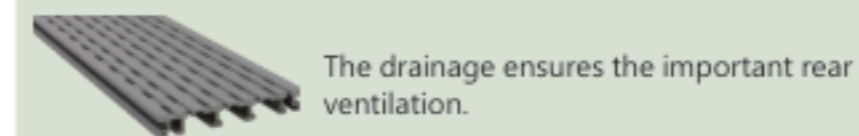

#### Weed mat 90 gr/m²

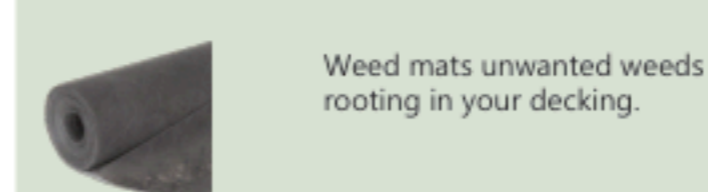

#### Pedestals including beam support



The example shows a 70 - 120 mm pedestal and beam support

The pedestals are available in different heights.

10 - 15 mm	40 - 70 mm
15 - 19 mm	70 - 120 mm
19 - 27 mm	120 - 170 mm
27 - 40 mm	

## DECKING BOARDS ASSEMBLY INSTRUCTIONS

### ALUMINIUM PROFILE 35 x 23 mm

#### Short description:

The decking system is suitable for use with invisible fastening. It can be adapted to the shape of the decking and expanded as desired. The 35 x 23 mm aluminium version is suitable for ground-level applications and should not be raised. The aluminium profiles must be fastened to the ground with a dowel or screw and pierced with a steel drill in the appropriate diameter. Anchoring in the ground makes cross braces unnecessary. Drilling in a concrete floor, tile floor or other materials, for example, is always at your own risk. Be sure to form an expansion joint with a substructure extension of about 5 mm.

#### Assembly:

In the first step, the floor must be prepared for the pads which act as underlays. Then, the pads are distributed on pavement plates, which serve as a support for the pads. Strip foundations are just as suitable as old stone decking as a substrate. A compacted substrate or an existing stone decking is also suitable. The pads provide good impact sound insulation, rear ventilation and drainage. The distance between the pads is 300 mm, the centre distance of the profiles is 40 cm **and the narrow side of the aluminium profile faces downwards.**

Even at this stage it is necessary to pay attention to where the **plank joints** are located. A double substructure must be generated for this so as to provide optimum support for the boards.

When extending the profile using a profile connector, the connection on both sides of the connector must be supported with additional pads.

To install the first plank, insert the start/end clamp into the profile using a screwdriver. The first plank is then carefully pushed into the clip. The tension is enough to hold the plank. When laying the substructure, at least 2 cm distance from the house wall or outer edge of the decking must be planned.

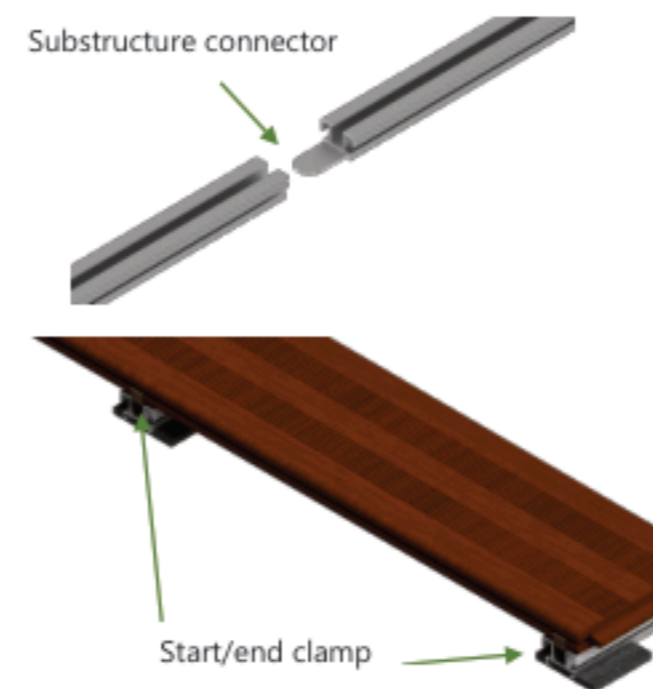
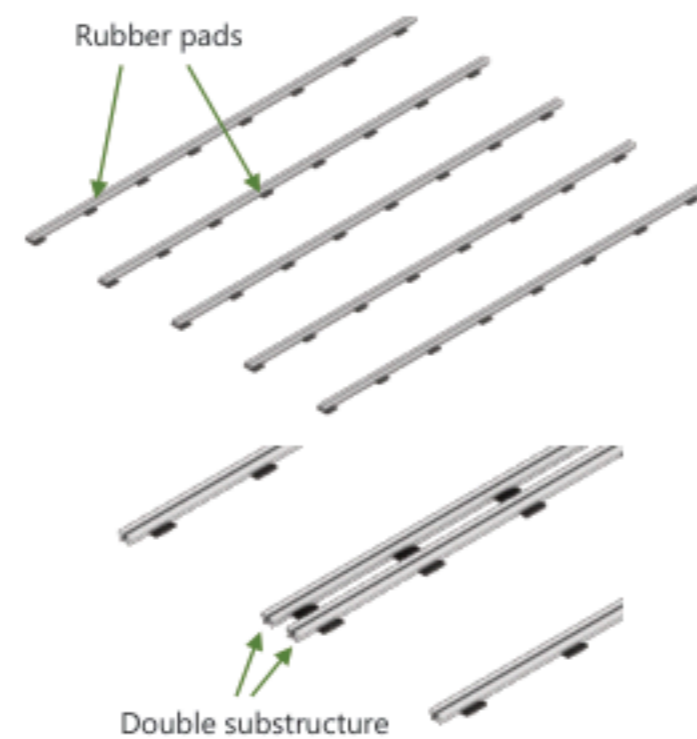

This process is repeated with all other the boards. Once the mounting clip has been placed between two decking boards in the aluminium profile, it can be screwed with a long bit. This is repeated to the last board. Care must be taken to ensure that the first two boards are aligned exactly. A poorly aligned plank cannot be corrected later.

At the end of the decking, the start/end clamp is inserted into the profile and the last plank. Now the decking is ready.

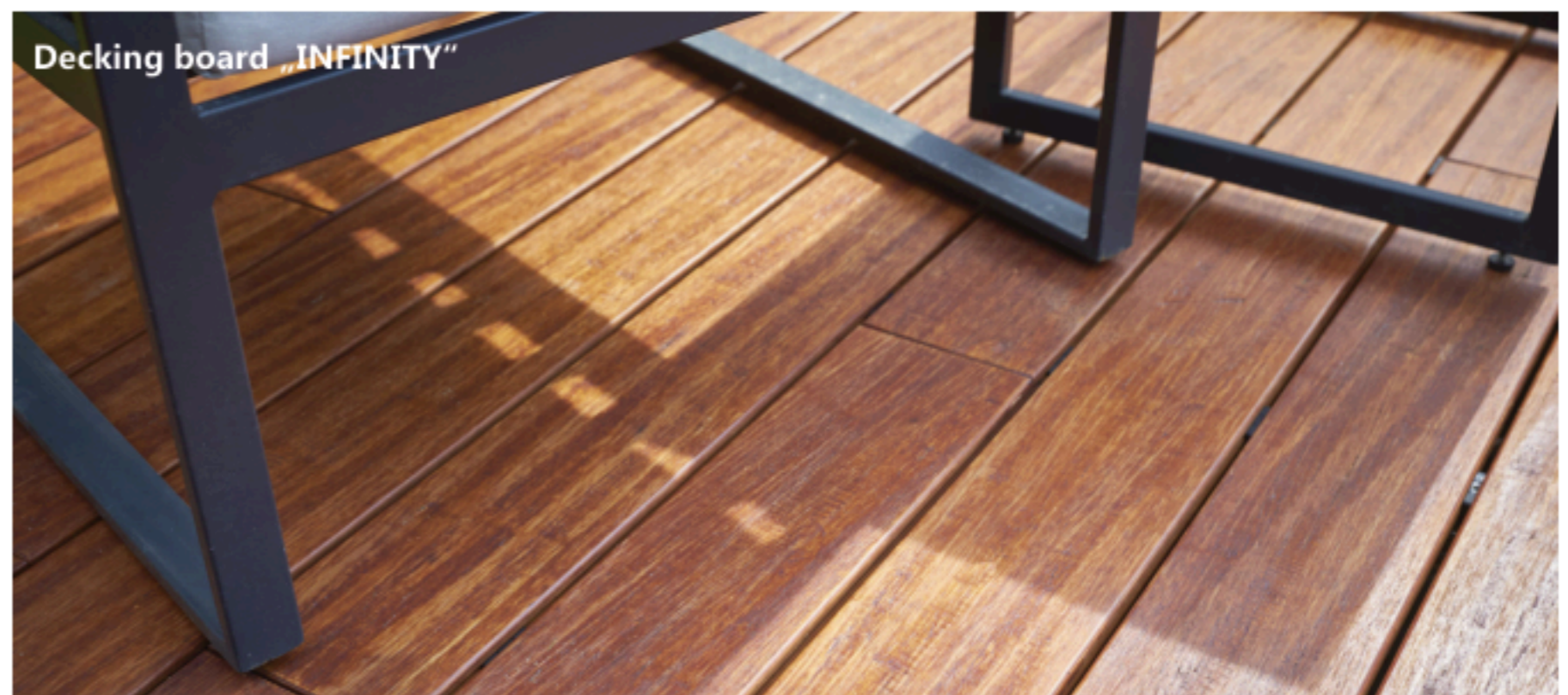
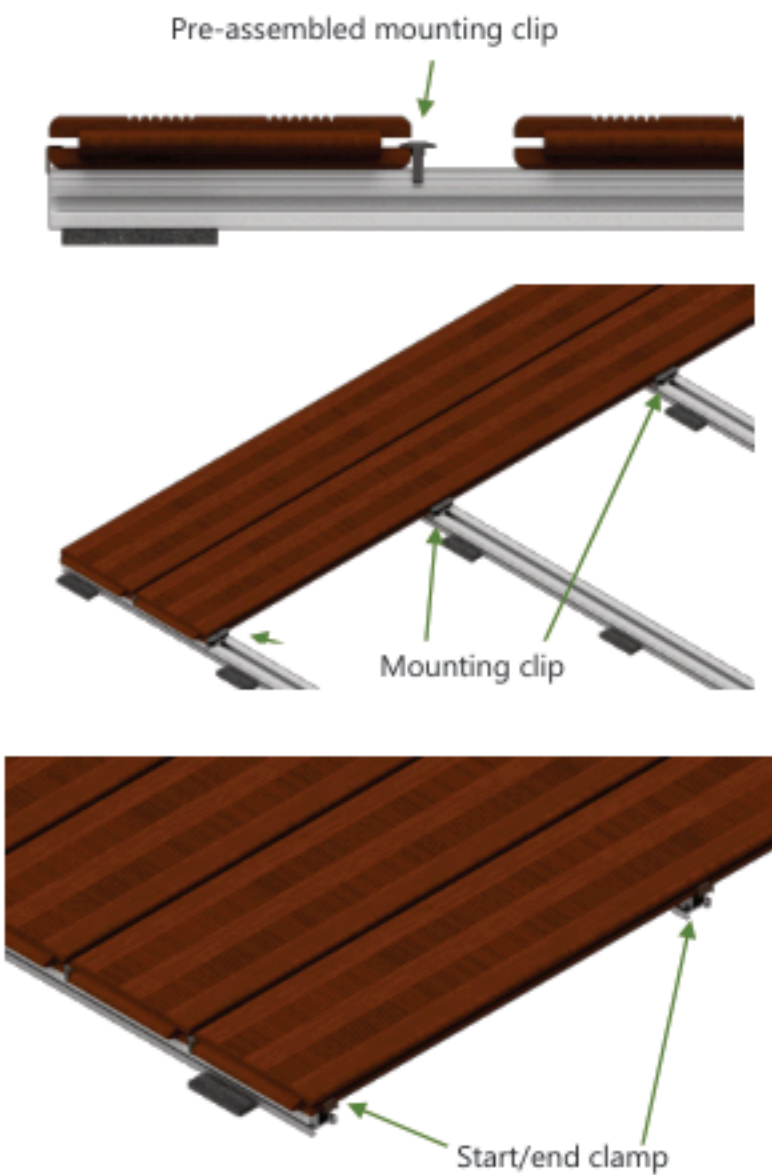

## DECKING BOARDS ASSEMBLY INSTRUCTIONS

### ALUMINIUM PROFILE 40 x 40 mm

#### Short description:

The decking system is suitable for use with invisible fastening. It can be adapted to the shape of the decking as desired. The system is installed floating without anchoring to the floor or a wall. Be sure to form an expansion joint with a substructure extension of about 5 mm. In addition to the installation with the displayed pedestal, the aluminium substructure can also be installed on our various pedestals (with different heights of 11-570 mm) or on our aMbooo® rubber pads. The pictures are shown with adjustable feet as an example. When using the displayed pedestals, make sure that the supplied metal plate is inserted. Use without a plate is not permitted.

#### Assembly:

To install the first plank, the aMbooo® start and end clamp is inserted into the profile using a screwdriver. The first plank is then carefully pushed into the aMbooo® clip. The tension is enough to hold the plank. When laying the substructure, sufficient distance to the house wall or outer edge of the decking must be planned.

In the first step, the floor must be prepared for the pedestals. Then, the pedestals with the profiles are set. The spacing of the pedestals depends on the location of the decking and the expected load. As a rule, the distance is 50 cm.

For mounting on the pedestals, the profiles are simply inserted into the foot. The incline (at least 1-2%) can be adjusted or the decking levelled using an adjustment screw on the sides of the pedestals.

The aluminium profiles are connected to a cross brace every 1.5 m. For this purpose, 2 multi-angles are attached to the sides. The profiles are cut to fit between the axes as per the centre distance.

Here it is necessary to pay attention to where the plank joints are. For this, a double substructure must be generated to optimally support the planks.

When extending the aluminium substructure using a profile connector, the connection on both sides of the profile connector must be supported with additional pedestals.

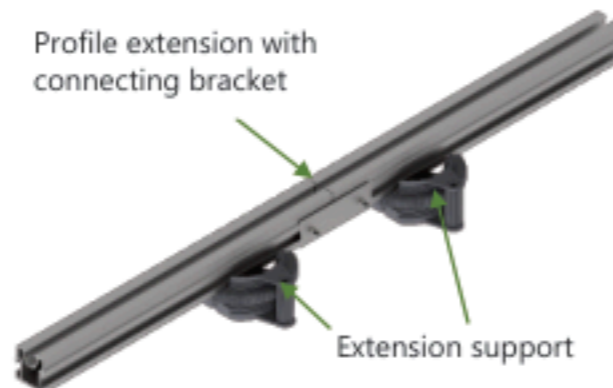
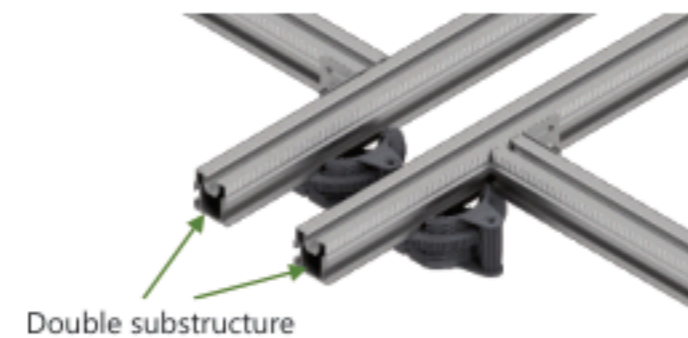
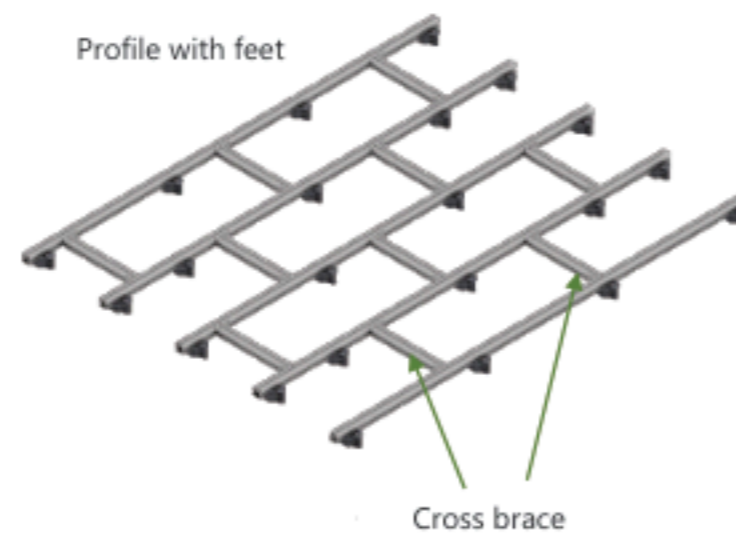

The first aMbooo® mounting clip can then be inserted into the profile. For this purpose, the slot nut of the aMbooo® mounting clip is inserted into the groove of the aluminium profile. The aMbooo® mounting clip is then pushed flush against the decking.

Once the aMbooo® mounting clip has been placed between two decking boards in the aluminium profile, the aMbooo® mounting clip can be screwed with a long bit. This is continued to the last board. Care must be taken to ensure that the first two boards are aligned exactly. A poorly aligned plank cannot be corrected later.

At the end of the decking, the aMbooo® start/end clamp is again inserted into the profile and the last plank. Now the decking is ready.

For veneering with our finishing board, an on-site solution must be found. Sufficient rear ventilation is mandatory.

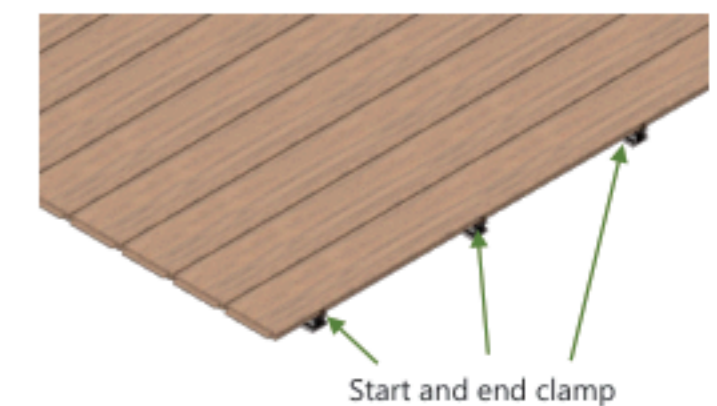
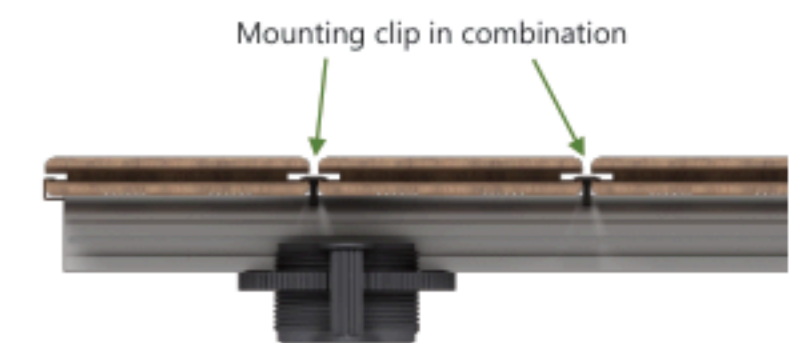
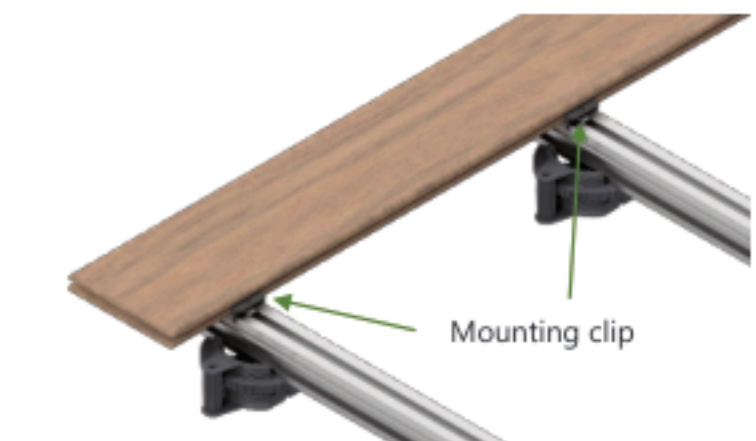
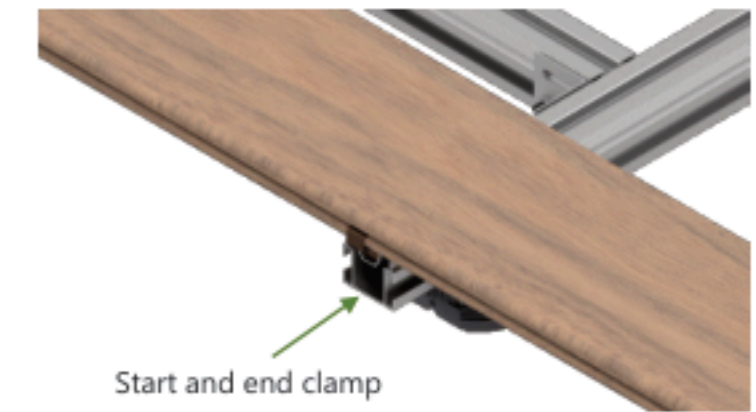

## DECKING BOARDS ASSEMBLY INSTRUCTIONS

### Assembly finishing board:

With raised decking, you can see under the decking. Provided that there is sufficient rear ventilation, the new decking can be used with a finishing board. For this purpose, the board must be pre-drilled and countersunk at the same centre distance as the substructure, so that the screw head disappears in the profile. Pre-drilling must take place as per the outer diameter of the screw - in the substructure itself with the core diameter of the screw. If two or more boards are used for facing, the gap between the end boards should be at least 2 cm for rear ventilation.

Just like the decking, the finishing board must be oiled. In addition, the cut edges must be treated with the edge wax.

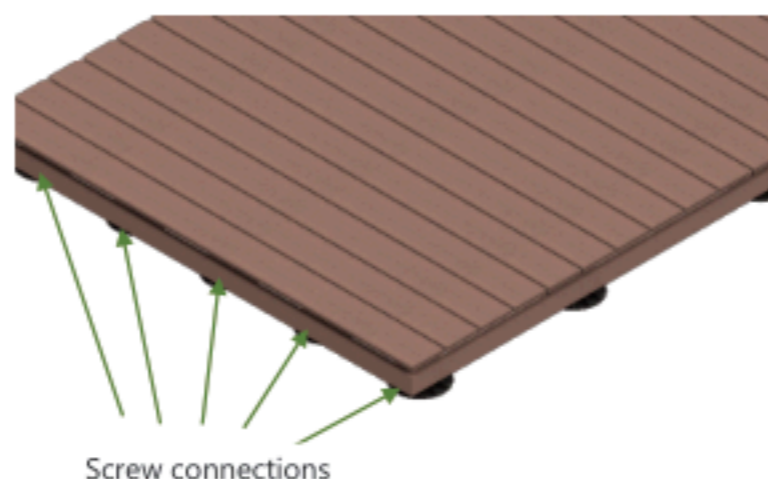

Screw connections



aMbooo®  
bamboo care oil



aMbooo®  
end-edge wax

### Natural features and care

The natural material bamboo has been a very popular building material for people in Asia for centuries. Very high strength, good processing possibilities and the unmistakable character of each individual component underline the uniqueness of this natural product.

**Tip:** For longer durability, the boards should be protected from damage. For example, the feet of tables and chairs can be covered with protective pads.

### Nodes

The natural appearance of aMbooo® decking includes so-called nodes. Nodes mark the growth boundaries between two segments of the bamboo tree. The distance between two segments varies depending on age and growing area between 10 and 50 cm. They give bamboo its special, extraordinary grain and structure.

### Natural substances

Bamboo belongs to the group of giant grasses. There are no escaping substances such as tannic acid, which can cause discolouration in adjacent components. Resin leaks as with wood are excluded.

### Greying and soiling

In the course of natural weathering and under the influence of UV radiation, the decking will fade in colour over time and maintain a natural patina. In direct comparison to commercially available decking wood (e.g. Bangkirai, Massaranduba, Cumaru, Ipe, etc.) bamboo does not turn grey. Depending on the state of care, location and ventilation situation of the decking, surface-pore soiling (e.g. verdigris, black discolouration or mildew) can develop over time. This is a natural process and can be almost completely eliminated with optimal cleaning and care schedules. For cleaning, use our aMbooo® cleaner and/or our aMbooo® anti-growth according to the instructions. An even better result can be achieved in combination with our silicon carbide brush. Then oil the cleaned surface with the appropriate aMbooo® bamboo care oil. To achieve optimal protection, we recommend treating the decking with our aMbooo® care oil at least once a year. The decking should only be treated with aMbooo® original care products. Please observe the recommended application quantity for the aMbooo® bamboo care oil and stir the container well before use.

**Tip:** For the initial care, use about 1 litre of oil per 10 square meters. Visit our website [ambooo.com](http://ambooo.com) for care tips and videos.

### Colour differences

From the nature of the material, decking surfaces can have different colours. This will adjust over time through weathering and regular oiling. If you have decided to install a profile side, the difference will be minimal. The planks are supplied pre-oiled. Initial and maintenance care will result in a uniform surface and a homogeneous overall appearance.

With the right aMbooo® cleaning and care, you can enjoy your decking. You will find the right products in our catalogue.

#### aMbooo® Special bamboo care oil



For regular treatment of your decking, for initial care or after cleaning.

#### aMbooo® anti-growth



Against green deposits.

#### aMbooo® Cleaner



Against soiling.

#### aMbooo® end edge wax



For sealing cut edges.

## DECKING BOARDS ASSEMBLY INSTRUCTIONS

### Warping, drying cracks, roughness and splinters

As soon as the decking is exposed to natural weathering, changes can occur on the surface. The decking will become rougher over time and there may be drying cracks and splinters. Due to the natural structure of the bamboo, these splinters are finer and longer compared to wood and may not be immediately visible. As with commercially available hardwoods, our decking is therefore not to be described as barefoot decking.

Depending on the location and weather-related stress, the characteristics mentioned can differ or not occur at all. Decking boards made of bamboo – as with hardwood – are not subject to DIN standards. Therefore, drying cracks, rough surfaces and splinter formation are generally permissible, do not constitute a reason for complaint and have no negative influence on static properties and durability. Warping and slight curling of up to 2 mm per 100 mm width is also permitted. These material changes can occur shortly after installation. Despite high-tech production processes, these characteristics - as with other common decking timbers - cannot be completely avoided.

Regular care (at least 1 - 2 x annual oiling and cleaning) can counteract the afore-mentioned characteristics. Please note that changes (cracks, roughness, etc.) are more noticeable or visible with a smooth surface than on a profiled one. Rough surfaces and splinters can be treated with our silicon carbide brush (i.e., smoothing the surface, removing the splinters) as required. If unevenness cannot be sufficiently corrected using the silicon carbide brush, the surface can also be sanded with a single-disc machine (80 grain recommended), provided that you have a smooth surface pro-file. After that, the surface must be treated again with the appropriate aMbooo® bamboo care oil.

### Swelling and shrinking

Bamboo is subject to typical weather and material-related swelling and shrinking of about 1% in length and approx. 0.2% across board width. Swelling and shrinking do not occur evenly due to the structure. As a result, drying cracks, dimensional changes and splintering may occur.

### Typical smell of aMbooo® decking on delivery

All our decking boards are subjected to thermal treatment, which creates the typical smell of our aMbooo® decking. This will decrease in intensity over time and is completely harmless.



**Our care oils** are available in the colours coffee, espresso, granite grey, white oak, amber and ipe.

### New tones for care!

New to our range are the aMbooo® care oils „Silver Grey” and „Midnight Black”. So you can easily recolour your decking and get a new look.

**Silver Grey**  
(only suitable for Primavera)

**Midnight Black**



### Fibres

The bamboo panels are made of long fibre bundles that extend over the entire length of the board. In rare cases, in thinner areas, such as corrugation, mechanical damage or weathering can cause the fibres to come loose, similar to a wood splinter/ chip. Clean the plank with an aMbooo® silicon brush and re-move the chip/ splinter will leave the surface smooth again.



### Cross-peeling

Due to the properties of bamboo, cross-peel can occur in places on the surface. Strong temperature changes cause fine cracks across the fibre, in rare cases a thin layer comes loose. This does not affect the dimensional stability of the decking.



### Cracks

Dry surfaces and moist undersides cause stresses in the material - one side tries to expand, the other side to shrink. These can lead to dry cracks. Such superficial cracks have no negative impact on the stability of the plank. The cracks change during the year - like the climate.

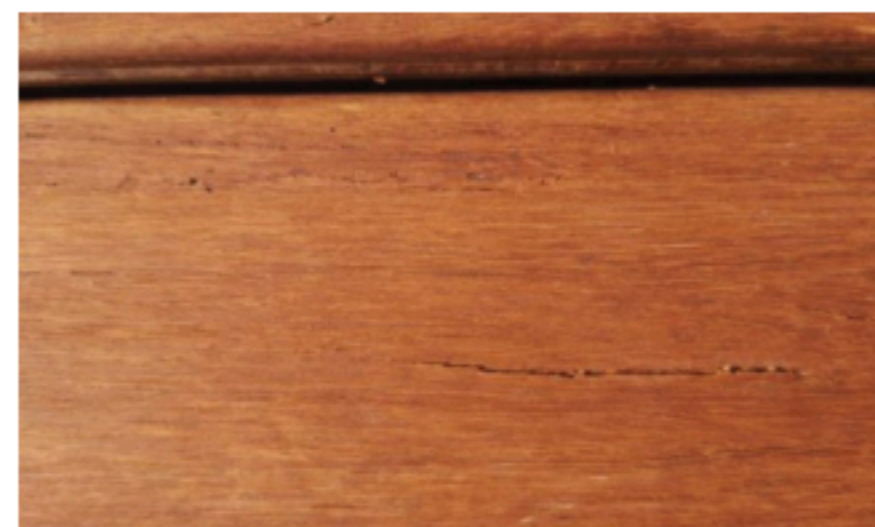

### Greying

Due to the UV radiation of the sun, all natural surfaces turn grey. This can be prevented by treating the planks once a year with an aMbooo® care oil. Very simple, very durable.





GS DECKING BOARDS ASSEMBLY INSTRUCTIONS  
VERSION 1 - 01/2023 v1

**Your specialist dealer (stamp)**



Further information and ideas for our decking boards, system fences and facade boards as well as assembly and maintenance instructions can be found on [www.amboo.com](http://www.amboo.com).

All information in the assembly instructions has been compiled to the best of our knowledge and belief. Subject to technical changes and printing errors! We apologize for any errors!