



IN230600536V02\_UK

**A71-005V00**

**A71-005\_A71-005V01**

**(ROUND FOLDABLE)**



**\*Please check the legs of the trampoline are firmly installed.**  
IMPORTANT, RETAIN FOR FUTURE REFERENCE: READ CAREFULLY

**ASSEMBLY & INSTRUCTION MANUAL**

**IN CASE OF MISSING OR BROKEN PARTS,  
PLEASE CONTACT PLACE OF PURCHASE FOR  
ASSISTANCE.**

**WE ARE NOT LIABLE FOR ANY INJURIES THAT  
MAY OCCUR WHEN USING THE TRAMPOLINE.**

Once a person on the trampoline

Max. User weight 100Kgs













## Table of contents

Parts list .....	3
Notes & Warnings .....	4
Assembly Instructions .....	5
Closing Instructions .....	6, 7
Assembly Instruction for stabilizing bar.....	8

## Parts list



Ref.No.	Part No.	Description	Unit
1	TR01	Trampoline frame with ropes & mat	1
2	TR02	Trampoline legs	6
3	TR03	Top handle T bar	1
4	TR04	Handle bar (top)	1
5	TR05	Handle bar(bottom)	1
6	TR06	Handle bar( connector)	1
7	TR07	Tool 1	1
	TR08	Tool 2	1
	TR09	Frame screws M8 x 80mm	2
	TR10	Top bar screws M8x30mm	1
	TR11	Adjust Screws M8x35mm	1
	TR12	bottom screws M8x15mm	2
8	TR13	Safety Screw	2

		
TR01 x 1pcs	TR02 x 6pcs	TR03 x 1pcs
		
TR04 x 1pcs	TR05 x 1pcs	TR06 x 1pcs
		
TR07 x 1pcs	TR08 x 1pcs	TR09 x 2pcs
		
TR10 x 1pcs	TR11 x 1pcs	TR12 x 2pcs
		
TR13 x 2pcs		

## Notes & Warnings

- The trampoline should be installed on a stable base and properly leveled.
- The legs of the trampoline are installed tightly, please make sure not to pinch your fingers or hand during assembly.
- The elastic cords can be stiff in the early stages of usage of the trampoline and will loosen with time. Please be careful while install the trampoline and do not hurt your hand.
- The handle bar when attached to the trampoline will have some movement, and is designed for aiding your balance only. It is not designed to support your entire weight.
- The product is for indoor use only. Always ensure that the trampoline is used by only one person at a time.
- The product should not be used by persons weighting more than 100kgs.
- Do not use trampoline if you have consumed alcohol or narcotic substances
- Must use the trampoline on wall to wall, carpet or a floor than is not slippery so unit does not slide when used.
- It's important to keep unsupervised children away from the trampoline when use the trampoline.
- It's important that when getting on the trampoline you shall not step on the frame as the trampoline otherwise tilts;



- The safety level of the trampoline can be maintained only if it is examination

regularly for damage and wear, e.g. elastic cords, connection points;

- Payspecial attention to components most susceptible to wear (e. g. mat, elastic cords);
- Replace defective components immediately and/or keep the equipment out of use until repair.
- Injuries to health may result from incorrect or excessive training.
- While use the product, enough free space (more than 1m from all directions) should be kept.



## WARNING

Keep others away from equipment when in use. Children under the age of 12 should be instructions before using the trampoline, as with any fitness exercise program consult with your doctor before use

### Assembly Instructions



**Please remove contents from the box and make note of the all the parts, the trampoline could be used with flat rubber tips , Always install your trampoline with 2 people.**

### OPEN INSTRUCTIONS

1. Lay the trampoline on the floor ,in its still folded position (**image 1**). Push out the ends according to the arrows on the picture, so the rebounder expands

and looks like a half moon (**image2**). Make sure the larger outside hinges are touching the floor

**WARNING: The trampoline needs to be open by two adults! And adjust the gap between the elastic ropes evenly after open.**

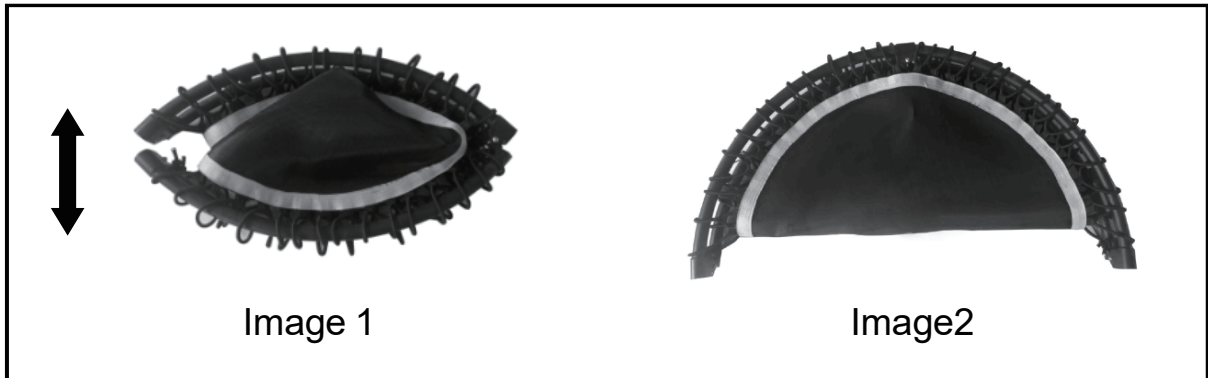

**Note: Frame will snap open so please read step No.2 carefully. Please keep all fingers away from hinge are when opening and closing.**

2. Using steady pressure with hands open and finger extended, use palm of hands to push top side of frame up, over and down to open position.(image 3)



Image 3

3. Install the safety screws on the hinge ( image4 ), for this trampoline will not fold when using .

Image4

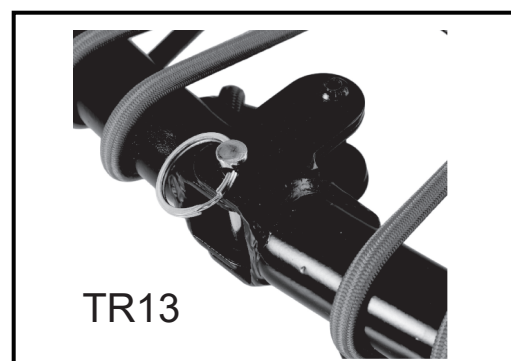

4. With the trampoline now open and still upside down, install each leg to a perpendicular position .



## CLOSING INSTRUCTIONS

**IMPORTANT SAFETY NOTE: Always close your trampoline with 2 people.**

1. Turn the unit upside down and lay it flat.
2. Take each leg out.
3. Locate the larger hinges on each side of the trampoline. Stand near the hinges on opposite sides of the trampoline facing the upper half of the frame

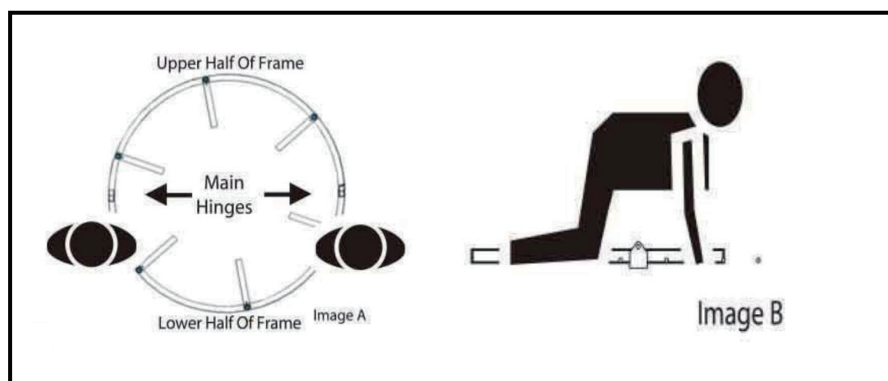

4. Both persons kneel facing the “top half” of the trampoline and place their knee closest to the trampoline on the “bottom half” of the frame approximately 2 inches below (not on) the hinge (**Image B**).

5. Both persons lean forward placing their outside hand on the ground and use their inside hand to grasp one of the spring ropes near the top of the trampoline (**image C**)

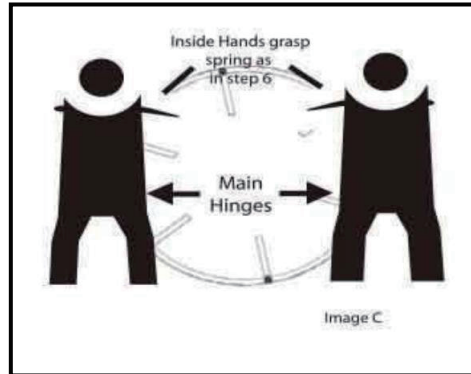

6. Together pull gently on the spring ropes and the top half of the frame will raise toward the middle. Ensure that your head is clear of moving frame

**Note: Watch out for your hands, feet body part, etc. And always take 2 people to fold the trampoline**

### Stabilizing Bar Assembly Instructions

Attention : There is a hole at center of the frame tube ,Before install the bottom connect bar , please find the hole first (as shown A).

1. Please fine out stabilizer bottom connect bar(TR06) , To install on two legs ,first remove rubber "feet" from this 2 legs ,as shown B and C, then replace rubber feet .

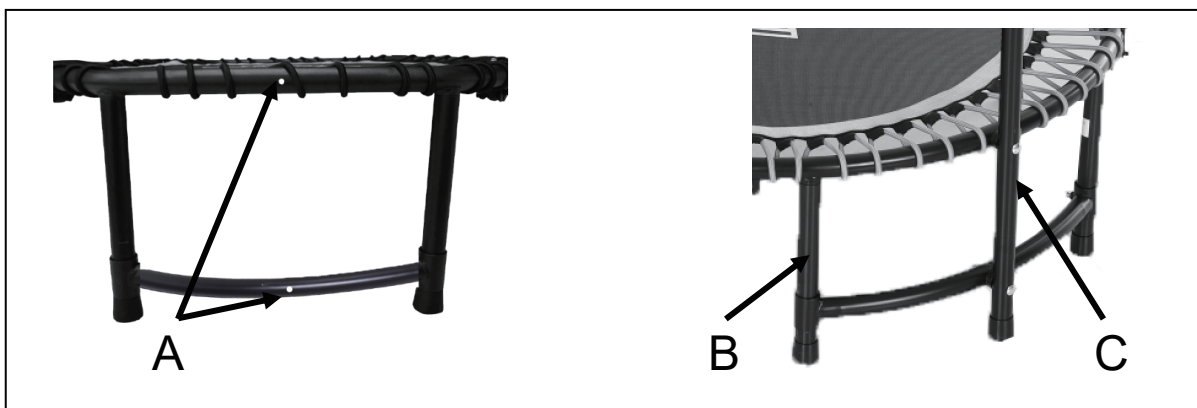

2. Now connect the trampoline frame(TR01) and connector(TR06) with the handle bar bottom (TR05) by two long screws.

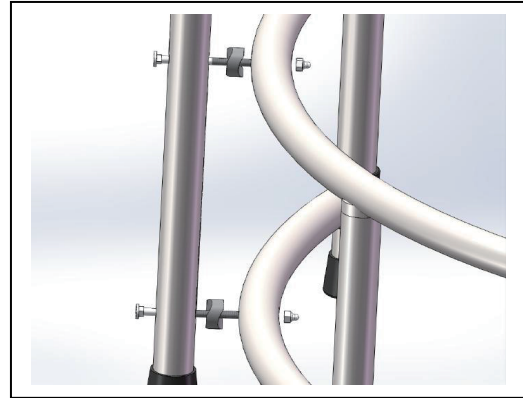

3. Then install the top bar(TR02) and adjust bar(TR03) by screws ,connect all parts as picture show



If you have any questions, please contact our customer care center.

Our contact details are below:



0044-800-240-4004



[enquiries@mhstar.co.uk](mailto:enquiries@mhstar.co.uk)

IMPORTER ADDRESS:  
MH STAR UK LTD  
Unit 27, Perivale Park,  
Horsenden lane South  
Perivale, UB6 7RH  
MADE IN CHINA