



IN221000808V02_GL

A20-232



EN_IMPORTANT, RETAIN FOR FUTURE REFERENCE: READ CAREFULLY.

FR_IMPORTANT: A LIRE ATTENTIVEMENT ET À CONSERVER POUR CONSULTATION ULTÉRIEURE.

ES_IMPORTANTE, LEA Y GUARDE PARA FUTURAS REFERENCIAS.

PT_IMPORTANTE, RETER PARA REFERÊNCIA FUTURA: LEIA ATENTAMENTE.

DE_WICHTIG! SORGFÄLTIG LESEN UND FÜR SPÄTER NACHSCHLAGEN AUFBEWAHREN.

IT_IMPORTANTE! CONSERVARE IL PRESENTE MANUALE PER FUTURO RIFERIMENTO E LEGGERLO ATTENTAMENTE.



WARNING: KEEP ALL FLAME AND HEAT SOURCES AWAY FROM THIS TENT.

This tent is not fireproof. The fabric will burn if left in continuous contact with a flame source.

Precautions

- Do NOT use candles, matches or other open flames in or near a tent.
- Fuel-powered lanterns and appliances are NOT recommended for use in or near a tent. If fuel-powered lanterns or appliances such as wood stoves or electric heaters are used, exercise extreme caution. Keep them away from the tent walls. Do NOT leave them unattended. Turn them off before going to sleep. Make sure the tent is well ventilated a tall times to avoid suffocation.
- Build campfires downwind and several metres away from a tent. Extinguish campfires before leaving a campsite or going to sleep.
- Do NOT fuel lamps, heaters or stoves in a tent.
- Do NOT smoke in a tent.
- Do NOT store flammable liquids in a tent. Keep exits clear.
- Do NOT apply any foreign substance to a tent. It may diminish the flame resistant properties of tent material(s).
- Follow manufacturer's instructions for safe appliance use.



MISE EN GARDE : TENIR CETTE TENTE LOIN DE TOUTE FLAMME ET DE TOUTE SOURCE DE CHALEUR.

Cette tente n'est pas ininflammable. Le tissu brûlera s'il est laissé en contact continu avec une source de flamme.

Précautions

- NE PAS utiliser de bougies, d'allumettes ou d'autres flammes nues à l'intérieur ou à proximité d'une tente.
- Les lanternes et les appareils utilisant un combustible NE sont PAS recommandés pour une utilisation à l'intérieur ou à proximité d'une tente. Si vous utilisez des lanternes ou des appareils à combustible, tels que des poêles à bois ou des radiateurs électriques, faites preuve d'une extrême prudence. Gardez-les loin des parois de la tente. NE les laissez PAS sans surveillance. Éteignez-les avant d'aller vous coucher. Assurez-vous que la tente est toujours bien ventilée pour éviter l'asphyxie.
- Construire les feux de camp sous le vent et à plusieurs mètres d'une tente. Éteindre les feux de camp avant de quitter un emplacement de camping ou d'aller se coucher.
- NE PAS faire le plein de lampes, d'appareils de chauffage ou de cuisinières dans une tente.
- NE PAS fumer dans une tente.
- NE PAS entreposer de liquides inflammables dans une tente.
- Garder les sorties dégagées.
- NE PAS appliquer de substances étrangères sur une tente. Cela peut diminuer les propriétés ignifuges des matériaux de la tente.
- Suivre les instructions du fabricant relatives à l'utilisation sécuritaire des appareils.



WARNUNG: HALTEN SIE ALLE FLAMMEN UND WÄRMEQUELLEN VON DIESEM ZELT FERN.

Dieses Zelt ist nicht feuerfest. Der Stoff wird brennen, wenn er in ständigem Kontakt mit einer Flamme bleibt.

Vorsichtsmaßnahmen

- Verwenden Sie KEINE Kerzen, Streichhölzer oder andere offene Flammen in oder in der Nähe eines Zeltes.
- Kraftstoffbetriebene Laternen und Geräte werden für die Verwendung in oder in der Nähe eines Zeltes NICHT empfohlen. Wenn solche Geräte wie Holzöfen oder elektrische Heizgeräte verwendet werden, ist äußerste Vorsicht geboten. Halten Sie sie von den Zeltwänden fern. Lassen Sie sie NICHT unbeaufsichtigt. Schalten Sie sie vor dem Schlafengehen aus. Stellen Sie sicher, dass das Zelt immer gut belüftet ist, um Erstickung zu vermeiden.
- Bauen Sie Lagerfeuer in Windrichtung und in mehreren Metern Entfernung vom Zelt auf. Löschen Sie Lagerfeuer, bevor Sie den Campingplatz verlassen oder schlafen gehen.
- Füllen Sie KEINE Lampen, Heizgeräte oder Öfen in einem Zelt nach.
- Rauchen Sie NICHT in einem Zelt.
- Lagern Sie KEINE brennbaren Flüssigkeiten in einem Zelt. Halten Sie die Ausgänge frei.
- Tragen Sie KEINE fremden Substanzen auf ein Zelt auf. Diese können die flammenhemmenden Eigenschaften des Zeltmaterials beeinträchtigen.
- Befolgen Sie die Anweisungen des Herstellers für die sichere Verwendung von Geräten.



ADVERTENCIA: MANTENGA TODAS LAS FUENTES DE LLAMA Y CALOR LEJOS DE ESTA TIENDA.

Esta tienda no es a prueba de fuego. La tela se quemará si se deja en contacto continuo con una fuente de llama.

Precauciones

- NO use velas, fósforos u otras llamas abiertas en o cerca de una tienda.
- Las linternas y los aparatos que funcionan con combustible NO se recomiendan para usar en o cerca de una tienda. Si utilizan linternas o aparatos como estufas de leña o calentadores eléctricos, tenga extrema precaución. Manténgalos alejados de las paredes de la tienda. NO los deje desatendidos. Apáguelos antes de ir a dormir. Asegúrese de que la tienda esté bien ventilada en todo momento para evitar la sofocación.
- Haga fogatas a favor del viento y a varios metros de distancia de una tienda. Apague las fogatas antes de abandonar el campamento o ir a dormir.
- NO recargue lámparas, calentadores o estufas en una tienda.
- NO fume en una tienda.
- NO almacene líquidos inflamables en una tienda. Mantenga las salidas despejadas.
- NO aplique ninguna sustancia extraña a una tienda. Podría disminuir las propiedades resistentes al fuego del material de la tienda.
- Siga las instrucciones del fabricante para un uso seguro de los aparatos.



ADVERTÊNCIA: MANTENHA TODAS AS FONTES DE CHAMA E CALOR LONGE DESTA TENDA.

Esta tenda não é à prova de fogo. O tecido queimará se mantido em contato contínuo com uma fonte de chama.

Precauções

- NÃO use velas, fósforos ou outras chamas abertas dentro ou perto de uma tenda.
- Lanternas e aparelhos movidos a combustível NÃO são recomendados para uso dentro ou perto de uma tenda. Se utilizarem lanternas ou aparelhos como fogões a lenha ou aquecedores elétricos, tenha extrema cautela. Mantenha-os afastados das paredes da tenda. NÃO os deixe sem supervisão. Desligue-os antes de dormir. Certifique-se de que a tenda esteja bem ventilada em todos os momentos para evitar asfixia.
- Faça fogueiras a favor do vento e a vários metros de distância de uma tenda. Apague as fogueiras antes de deixar o acampamento ou dormir.
- NÃO abasteça lâmpadas, aquecedores ou fogões dentro de uma tenda.
- NÃO fume dentro de uma tenda.
- NÃO armazene líquidos inflamáveis dentro de uma tenda. Mantenha as saídas desobstruídas.
- NÃO aplique nenhuma substância estranha a uma tenda. Pode diminuir as propriedades resistentes ao fogo do material da tenda.
- Siga as instruções do fabricante para o uso seguro dos aparelhos.



AVVERTENZA: TENERE TUTTE LE FONTI DI FIAMMA E CALORE LONTANO DA QUESTA TENDA.

Questa tenda non è ignifuga. Il tessuto brucerà se lasciato a contatto continuo con una fonte di fiamma.

Precauzioni

- NON utilizzare candele, fiammiferi o altre fiamme libere dentro o vicino a una tenda.
- Le lanterne e gli apparecchi a combustibile NON sono raccomandati per l'uso dentro o vicino a una tenda. Se si utilizzano lanterne o apparecchi come stufe a legna o riscaldatori elettrici, esercitare estrema cautela. Tenerli lontani dalle pareti della tenda. NON lasciarli incustoditi. Spegnerli prima di andare a dormire. Assicurarsi che la tenda sia sempre ben ventilata per evitare il soffocamento.
- Costruire i falò sottovento e a diversi metri di distanza da una tenda. Spegnerli prima di lasciare il campeggio o andare a dormire.
- NON riempire lampade, riscaldatori o stufe all'interno di una tenda.
- NON fumare all'interno di una tenda.
- NON conservare liquidi infiammabili all'interno di una tenda. Mantenere le uscite libere.
- NON applicare nessuna sostanza estranea a una tenda. Potrebbe diminuire le proprietà di resistenza alla fiamma del materiale della tenda.
- Seguire le istruzioni del produttore per l'utilizzo sicuro degli apparecchi.

A x2



B x4

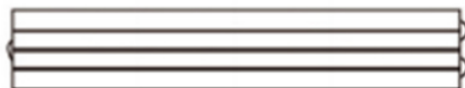

C x2

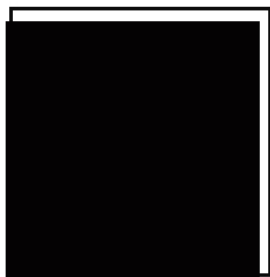

D x12



F x4

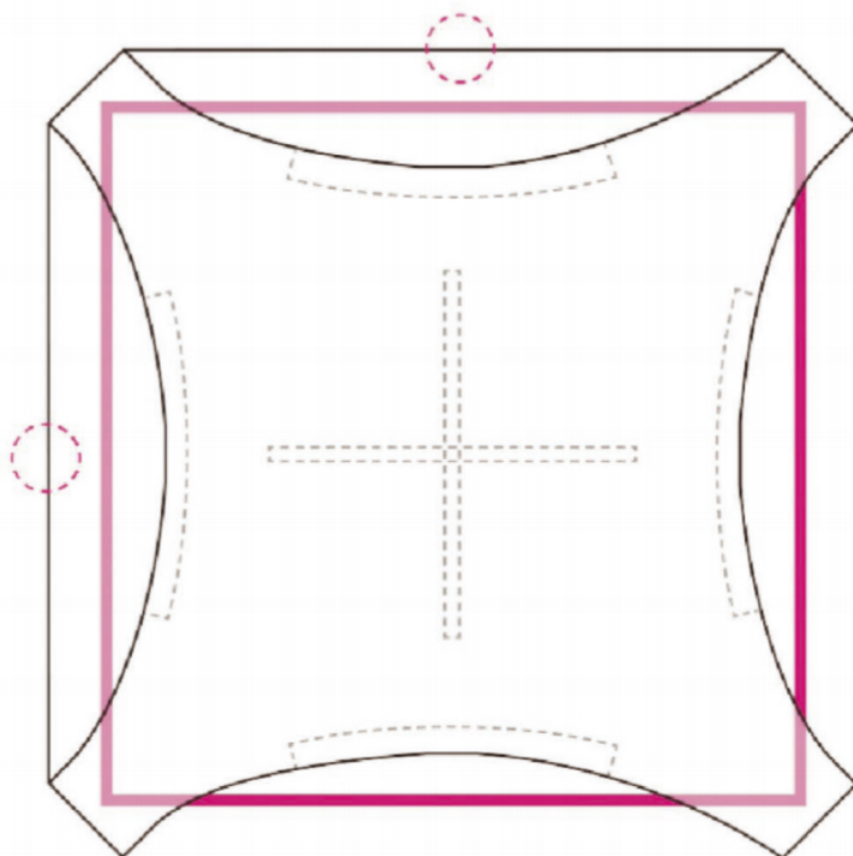

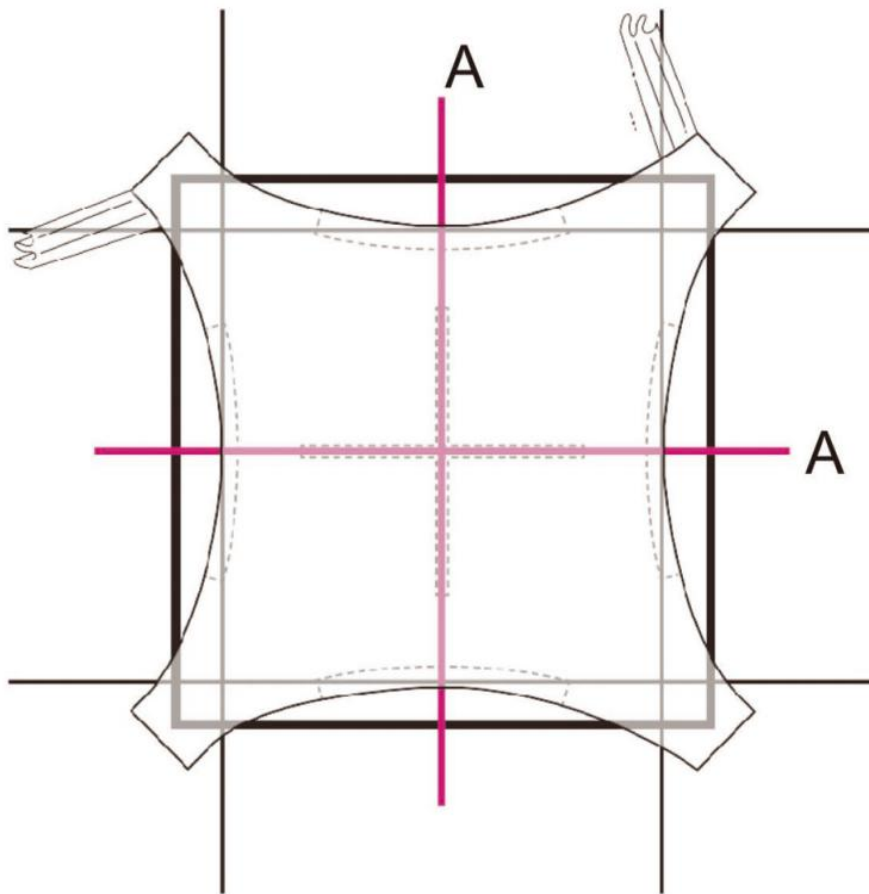
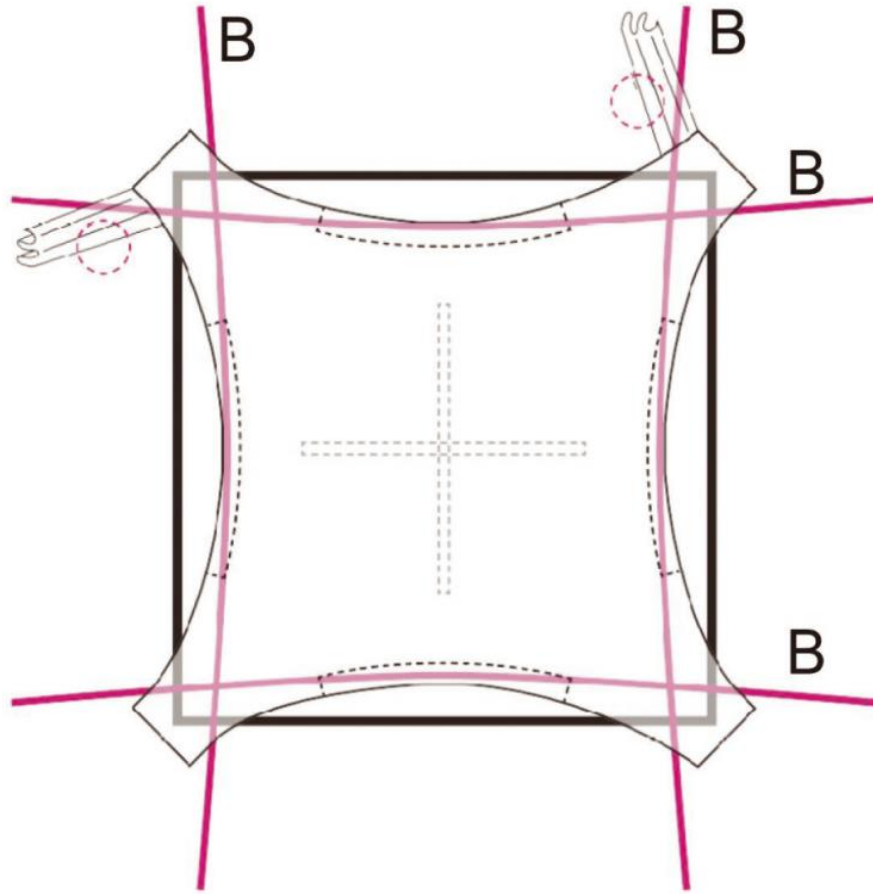

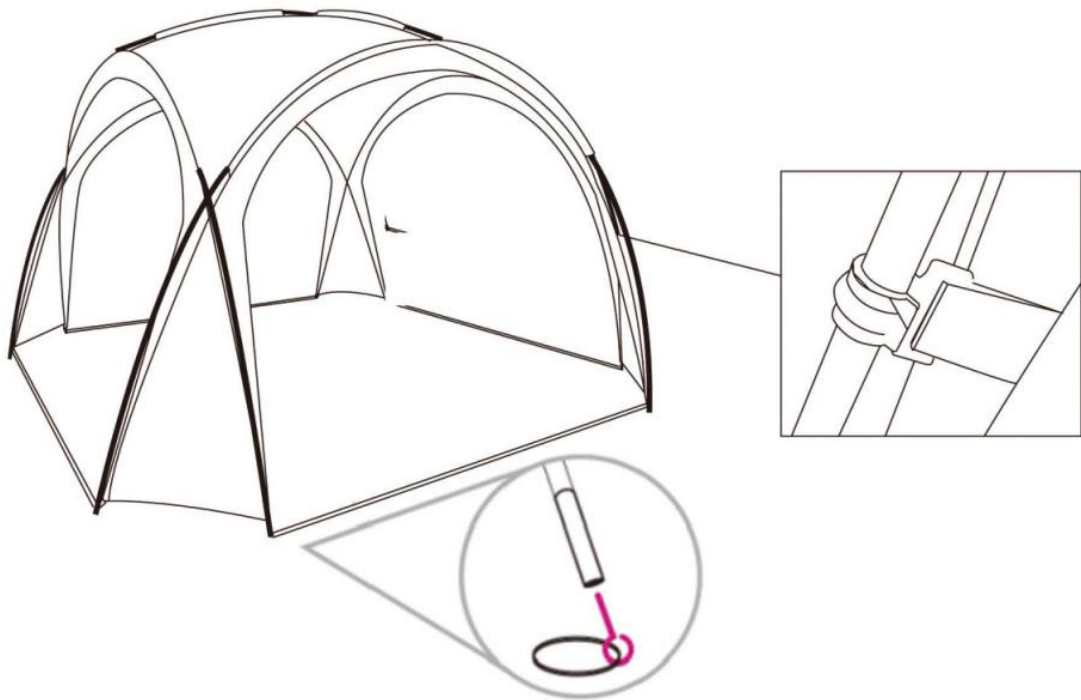
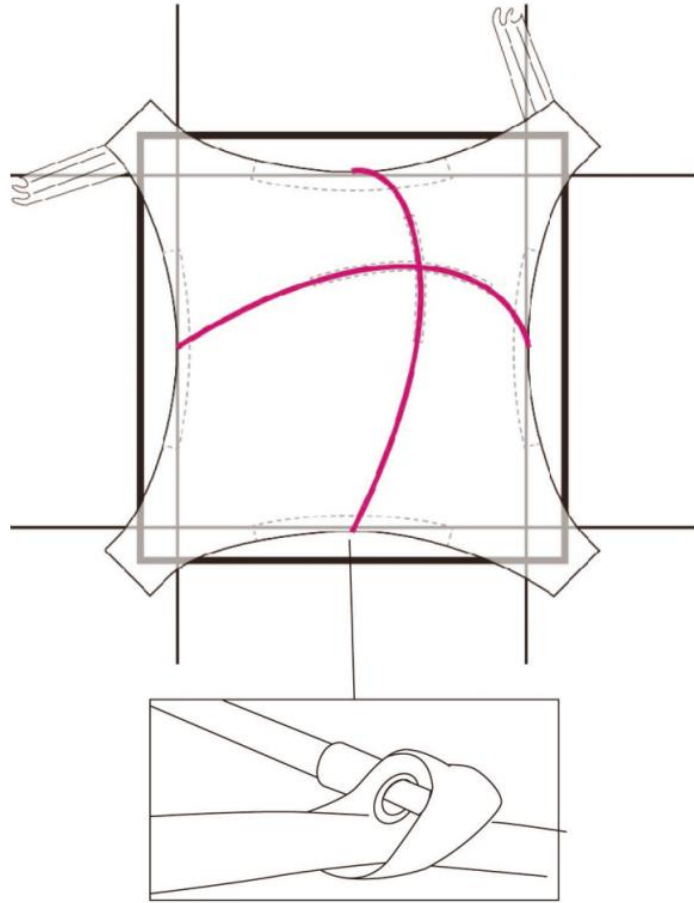

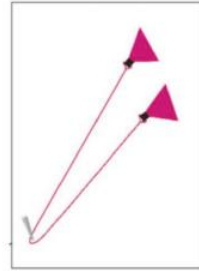

If you have any questions, please contact our customer care center, Our contact details are below:

US

 001-877-644-9366

 customerservice@aosom.com

Imported by Aosom LLC
27150 SW Kinsman Rd Wilsonville, OR 97070 USA
MADE IN CHINA

If you have any questions, please contact our customer care center, Our contact details are below:

CA

 416-792-6088

 customerservice@aosom.ca

Imported by Aosom Canada Inc.
7270 Woodbine Avenue, Unit 307, Markham,
Ontario Canada L3R 4B9
MADE IN CHINA

Si vous avez la moindre question, veuillez contacter notre centre d'assistance à la clientèle, Nos coordonnées sont les suivantes:

 416-792-6088

 customerservice@aosom.ca

Importé par Aosom Canada Inc.
7270 Woodbine Avenue, unité 307,
Markham, Ontario Canada L3R 4B9
FABRIQUÉ EN CHINE

If you have any questions, please contact our customer care center, Our contact details are below:

UK

 0044-800-240-4004

 enquiries@mhstar.co.uk

IMPORTER ADDRESS:
MH STAR UK LTD
Unit 27, Perivale Park,
Horsenden lane South
Perivale, UB6 7RH
MADE IN CHINA

Si vous avez la moindre question, veuillez contacter notre centre d'assistance à la clientèle, Nos coordonnées sont les suivantes:

FR

 0033-1-84166106

 aosom@mhfrance.fr

Importé par/Fabricant/REP:
MH FRANCE
2 Rue Maurice Hartmann
92130 Issy Les Moulineaux
France
FABRIQUÉ EN CHINE

Wenn Sie Fragen haben, wenden Sie sich bitte an unser Kundendienstzentrum, Unsere Kontaktdaten stehen unten:

DE

 0049-0(40)-87408465

 service@aosom.de

ADRESSE DES IMPORTEURE/Hersteller/REP:
MH Handel GmbH
Wendenstraße 309
D-20537 Hamburg
Germany
IN CHINA HERGESTELLT

In caso di dubbio, si prega di contattare il nostro centro assistenza clienti, I nostri dettagli di contatto sono di seguito:

IT

 0039-0249471447

 clienti@aosom.it

IMPORTATO DA/Produttore/REP:
AOSOM Italy srl
Centro Direzionale Milanofiori
Strada 1 Palazzo F1
20057 Assago (MI)
P.I.: 08567220960
FATTO IN CINA

Si tiene alguna pregunta, comuníquese con nuestro Centro de Atención al Cliente, Nuestros datos de contacto son los siguientes:

ES

 0034-931294512

 atencioncliente@aosom.es

IMPORTADOR/Fabricante/REP:
SPANISH AOSOM, S.L.
C/ROC GROS, N°15.08550, ELS HOSTALETES DE
BALENYÀ, SPAIN.
B66295775
HECHO EN CHINA

Se tiver alguma dúvida, por favor contacte o nosso Centro de Atendimento ao Cliente, Os nossos dados de contacto são os seguintes:

 0034-931294512

 info@aosom.pt.

IMPORTADOR/Fabricante/REP:
SPANISH AOSOM, S.L.
C.ROC GROS N.15, 08550. ELS HOSTALETES DE
BALENYÀ
FEITO NA CHINA



FR

**DONNEZ
OU
RECYCLEZ**



ASSOCIATION

OU



LIVRAISON

OU



DÉCHÈTERIE

Adresses sur quefairedemesdechets.fr