

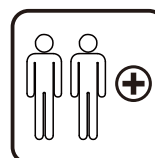

IN221000525V03_GL

84G-045V00



EN_IMPORTANT, RETAIN FOR FUTURE REFERENCE: READ CAREFULLY.

FR_IMPORTANT: A LIRE ATTENTIVEMENT ET À CONSERVER POUR CONSULTATION ULTÉRIEURE.

ES_IMPORTANTE, LEA Y GUARDE PARA FUTURAS REFERENCIAS.

PT_IMPORTANTE, RETER PARA REFERÊNCIA FUTURA: LEIA ATENTAMENTE.

DE_WICHTIG! SORGFÄLTIG LESEN UND FÜR SPÄTER NACHSCHLAGEN AUFBEWAHREN.

IT_IMPORTANTE! CONSERVARE IL PRESENTE MANUALE PER FUTURO RIFERIMENTO E LEGGERLO ATTENTAMENTE.

IMPORTANT, RETAIN FOR FUTURE REFERENCE: READ CAREFULLY.

Only for domestic use

Assembly Instructions (If Applicable):

- Unpack all components and check against the parts list: [e.g., tabletop, legs, screws, etc.].
- Attach the legs to the tabletop using the provided screws and tools, following the numbered steps in the enclosed diagram.
- Ensure all connections are secure and stable before use.
- Do not overtighten screws to avoid damaging the frame.

Care and Maintenance Instructions:

- Clean the table with a soft, damp cloth and mild soap. Avoid abrasive cleaners or harsh chemicals that may damage the surface.
- Store in a dry, shaded area when not in use to prevent weather-related wear.
- Inspect regularly for signs of damage or wear; do not use if structural integrity is compromised.

Warning (If Applicable):

For tables with a parasol hole: This table includes a hole for a parasol. However, it is not designed to support a parasol on its own. Always use a parasol with a suitable weighted base to ensure stability and prevent tipping. Failure to do so may result in damage or injury.

IMPORTANT, À CONSERVER POUR RÉFÉRENCE FUTURE : LIRE ATTENTIVEMENT

Uniquement pour un usage domestique

Instructions de montage (si applicable) :

- Déballez tous les composants et vérifiez-les par rapport à la liste des pièces : [par ex., plateau, pieds, vis, etc.].
- Fixez les pieds au plateau à l'aide des vis et outils fournis, en suivant les étapes numérotées du schéma inclus.
- Assurez-vous que toutes les connexions sont sécurisées et stables avant utilisation.
- Ne vissez pas trop fort pour éviter d'endommager le cadre.

Instructions d'entretien et de maintenance :

- Nettoyez la table avec un chiffon doux et humide et du savon doux. Évitez les nettoyeurs abrasifs ou les produits chimiques agressifs qui pourraient endommager la surface.
- Rangez-la dans un endroit sec et ombragé lorsqu'elle n'est pas utilisée pour éviter l'usure liée aux intempéries.
- Inspectez régulièrement pour détecter tout signe de dommage ou d'usure ; n'utilisez pas la table si son intégrité structurelle est compromise.

ATTENTION (si applicable) :

Pour les tables avec un trou pour parasol : Cette table comporte un trou pour un parasol. Cependant, elle n'est pas conçue pour supporter un parasol seule. Utilisez toujours un parasol avec une base lestée appropriée pour garantir la stabilité et éviter qu'il ne bascule. Ne pas respecter cette consigne peut entraîner des dommages ou des blessures.

IMPORTANTE, CONSERVE PARA REFERENCIA FUTURA: LEA CUIDADOSAMENTE

Solo para uso doméstico

Instrucciones de montaje (si aplica):

- Desembale todos los componentes y verifíquelos con la lista de piezas: [por ejemplo, tablero, patas, tornillos, etc.].
- Fije las patas al tablero utilizando los tornillos y herramientas proporcionados, siguiendo los pasos numerados del diagrama adjunto.
- Asegúrese de que todas las conexiones estén seguras y estables antes de usar.
- No apriete los tornillos en exceso para evitar dañar el marco.

Instrucciones de cuidado y mantenimiento:

- Limpie la mesa con un paño suave y húmedo y jabón suave. Evite limpiadores abrasivos o productos químicos agresivos que puedan dañar la superficie.
- Guárdela en un lugar seco y sombreado cuando no esté en uso para prevenir el desgaste relacionado con el clima.
- Inspeccione regularmente en busca de signos de daño o desgaste; no la use si la integridad estructural está comprometida.

Advertencia (si aplica):

Para mesas con orificio para sombrilla: Esta mesa incluye un orificio para una sombrilla. Sin embargo, no está diseñada para soportar una sombrilla por sí sola. Siempre use una sombrilla con una base pesada adecuada para garantizar la estabilidad y evitar que se vuelque. No seguir esta indicación puede resultar en daños o lesiones.

IMPORTANTE, GARDE PARA REFERÊNCIA FUTURA: LEIA COM ATENÇÃO

Apenas para uso doméstico

Instruções de montagem (se aplicável):

- Desembale todos os componentes e verifique-os com a lista de peças: [por exemplo, tampo, pernas, parafusos, etc.].
- Fixe as pernas ao tampo usando os parafusos e ferramentas fornecidos, seguindo os passos numerados no diagrama anexado.
- Certifique-se de que todas as conexões estejam seguras e estáveis antes de usar.
- Não aperte os parafusos excessivamente para evitar danificar a estrutura.

Instruções de cuidado e manutenção:

- Limpe a mesa com um pano macio e úmido e sabão neutro. Evite limpadores abrasivos ou produtos químicos agressivos que possam danificar a superfície.
- Guarde-a em um local seco e sombreado quando não estiver em uso para evitar desgaste relacionado ao clima.
- Inspeccione regularmente em busca de sinais de danos ou desgaste; não use a mesa se a integridade estrutural estiver comprometida.

Aviso (se aplicável):

Para mesas com orifício para guarda-sol: Esta mesa inclui um orifício para um guarda-sol. No entanto, não foi projetada para suportar um guarda-sol sozinha. Sempre use um guarda-sol com uma base pesada adequada para garantir estabilidade e evitar que tombe. Não seguir essa instrução pode resultar em danos ou ferimentos.

WICHTIG, FÜR ZUKÜNFTIGE REFERENZ AUFBEWAHREN: SORGFÄLTIG LESEN

Nur für den Hausgebrauch

Montageanleitung (falls zutreffend):

- Packen Sie alle Komponenten aus und überprüfen Sie sie anhand der Teilleiste: [z. B. Tischplatte, Beine, Schrauben usw.].
- Befestigen Sie die Beine an der Tischplatte mit den mitgelieferten Schrauben und Werkzeugen, indem Sie den nummerierten Schritten im beiliegenden Diagramm folgen.
- Stellen Sie sicher, dass alle Verbindungen sicher und stabil sind, bevor Sie den Tisch verwenden.
- Ziehen Sie die Schrauben nicht zu fest an, um Schäden am Rahmen zu vermeiden.

Pflege- und Wartungsanweisungen:

- Reinigen Sie den Tisch mit einem weichen, feuchten Tuch und milder Seife. Vermeiden Sie abrasive Reiniger oder aggressive Chemikalien, die die Oberfläche beschädigen könnten.
- Lagern Sie ihn bei Nichtgebrauch an einem trockenen, schattigen Ort, um witterungsbedingten Verschleiß zu verhindern.
- Überprüfen Sie regelmäßig auf Anzeichen von Schäden oder Verschleiß; verwenden Sie den Tisch nicht, wenn die strukturelle Integrität beeinträchtigt ist.

ACHTUNG (falls zutreffend):

Für Tische mit einem Sonnenschirmloch: Dieser Tisch hat ein Loch für einen Sonnenschirm. Er ist jedoch nicht dafür ausgelegt, einen Sonnenschirm allein zu tragen. Verwenden Sie immer einen Sonnenschirm mit einer geeigneten, beschwerten Basis, um Stabilität zu gewährleisten und ein Umkippen zu verhindern. Bei Nichtbeachtung kann es zu Schäden oder Verletzungen kommen.

IMPORTANTE, CONSERVARE PER FUTURO RIFERIMENTO: LEGGERE ATTENTAMENTE

Solo per uso domestico

Istruzioni di montaggio (se applicabile):

- Disimballare tutti i componenti e controllarli rispetto alla lista delle parti: [ad es. piano del tavolo, gambe, viti, ecc.].
- Fissare le gambe al piano del tavolo utilizzando le viti e gli strumenti forniti, seguendo i passaggi numerati nel diagramma allegato.
- Assicurarsi che tutte le connessioni siano sicure e stabili prima dell'uso.
- Non stringere eccessivamente le viti per evitare di danneggiare la struttura.

Istruzioni per la cura e la manutenzione:

- Pulire il tavolo con un panno morbido e umido e sapone delicato. Evitare detergenti abrasivi o prodotti chimici aggressivi che potrebbero danneggiare la superficie.
- Conservarlo in un luogo asciutto e ombreggiato quando non in uso per prevenire l'usura dovuta alle intemperie.
- Ispezionare regolarmente per rilevare segni di danni o usura; non utilizzare il tavolo se l'integrità strutturale è compromessa.

Avvertenza (se applicabile):

Per tavoli con foro per ombrellone: Questo tavolo include un foro per un ombrellone. Tuttavia, non è progettato per sostenere un ombrellone da solo. Utilizzare sempre un ombrellone con una base adeguatamente zavorrata per garantire stabilità e prevenire ribaltamenti. La mancata osservanza di questa indicazione può causare danni o lesioni.

① x01



② x04



③ x01



HARDWARE

A x08
M8
+1(spare)

B x08
M8
+1(spare)

C x08
M8
+1(spare)

D x08
M8
+1(spare)

E x08
M8
+1(spare)

④ x01



⑤ x01



EN Do not confuse similar screws. Do not tighten bolts fully until all parts are connected!
FR Ne pas confondre des vis similaires. Ne serrez pas les boulons à fond tant que toutes les pièces ne sont pas connectées!

ES No confunda tornillos similares. No apriete los tornillos completamente hasta que todas las partes están conectadas!

PT Não confundir parafusos semelhantes. Não apertar completamente os parafusos até que todas as peças estejam encaixadas!

DE Verwechseln Sie ähnliche Schrauben nicht. Ziehen Sie die Schrauben erst fest an, wenn alle Teile verbunden sind!

IT Non confondere le viti simili. non serrare completamente i bulloni fino a tutte le parti non sono ancora collegate!

NOTE

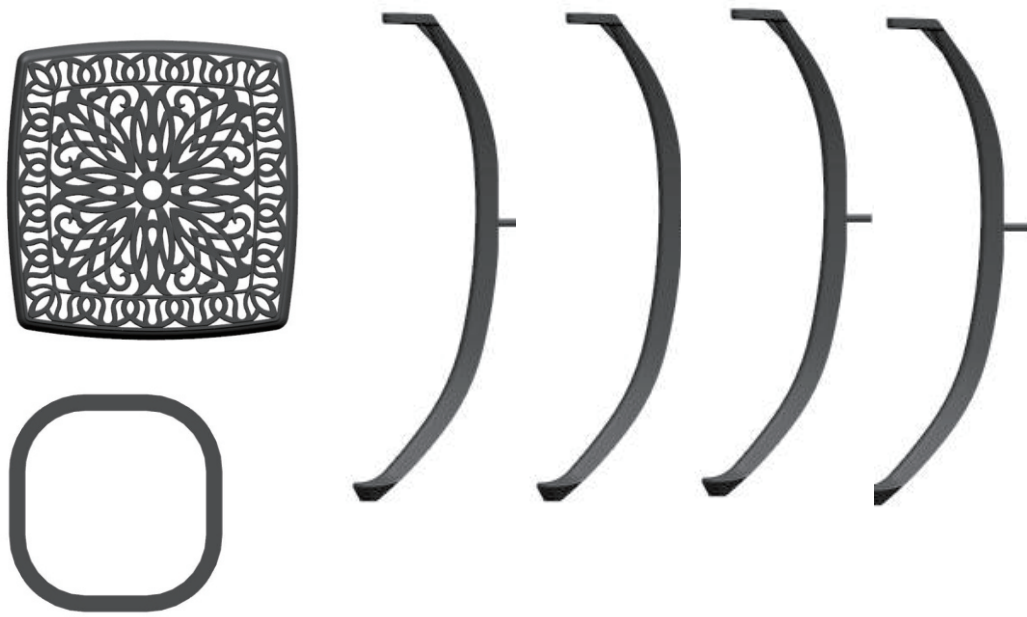

- A** x04
M8
- B** x04
M8
- C** x04
M8
- E** x04
M8



A x04

M8

**B** x04

M8

**C** x04

M8

**E** x04

M8



A



B



C



E

**D** x08

M8



D

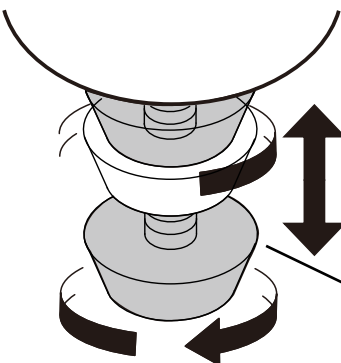

EN Adjust up and down for balance
FR Ajuster l'équilibre vers le haut et le bas
ES Ajuste hacia arriba y abajo para equilibrar
PT Ajustar para cima e para baixo para obter equilíbrio
DE Nach oben und unten für das Gleichgewicht einstellen
IT Regolare il bilanciamento verso l'alto e verso il basso

Done

If you have any questions, please contact our customer care center, Our contact details are below:

US

 001-877-644-9366

 customerservice@aosom.com

Imported by Aosom LLC
27150 SW Kinsman Rd Wilsonville, OR 97070 USA
MADE IN CHINA

If you have any questions, please contact our customer care center, Our contact details are below:

CA

 416-792-6088

 customerservice@aosom.ca

Imported by Aosom Canada Inc.
7270 Woodbine Avenue, Unit 307, Markham,
Ontario Canada L3R 4B9
MADE IN CHINA

Si vous avez la moindre question, veuillez contacter notre centre d'assistance à la clientèle, Nos coordonnées sont les suivantes:

 416-792-6088

 customerservice@aosom.ca

Importé par Aosom Canada Inc.
7270 Woodbine Avenue, unité 307,
Markham, Ontario Canada L3R 4B9
FABRIQUÉ EN CHINE

If you have any questions, please contact our customer care center, Our contact details are below:

UK

 0044-800-240-4004

 enquiries@mhstar.co.uk

IMPORTER ADDRESS:
MH STAR UK LTD
Unit 27, Perivale Park,
Horsenden lane South
Perivale, UB6 7RH
MADE IN CHINA

Si vous avez la moindre question, veuillez contacter notre centre d'assistance à la clientèle, Nos coordonnées sont les suivantes:

FR

 0033-1-84166106

 aosom@mhfrance.fr

Importé par/Fabricant/REP:
MH FRANCE
2 Rue Maurice Hartmann
92130 Issy Les Moulineaux
France
FABRIQUÉ EN CHINE

Wenn Sie Fragen haben, wenden Sie sich bitte an unser Kundendienstzentrum, Unsere Kontaktdaten stehen unten:

DE

 0049-0(40)-87408465

 service@aosom.de

ADRESSE DES IMPORTEURE/Hersteller/REP:
MH Handel GmbH
Wendenstraße 309
D-20537 Hamburg
Germany
IN CHINA HERGESTELLT

In caso di dubbio, si prega di contattare il nostro centro assistenza clienti, I nostri dettagli di contatto sono di seguito:

IT

 0039-0249471447

 clienti@aosom.it

IMPORTATO DA/Produttore/REP:
AOSOM Italy srl
Centro Direzionale Milanofiori
Strada 1 Palazzo F1
20057 Assago (MI)
P.I.: 08567220960
FATTO IN CINA

Si tiene alguna pregunta, comuníquese con nuestro Centro de Atención al Cliente, Nuestros datos de contacto son los siguientes:

ES

 0034-931294512

 atencioncliente@aosom.es

IMPORTADOR/Fabricante/REP:
SPANISH AOSOM, S.L.
C/ROC GROS, N°15.08550, ELS HOSTALETES DE
BALENYÀ, SPAIN.
B66295775
HECHO EN CHINA

Se tiver alguma dúvida, por favor contacte o nosso Centro de Atendimento ao Cliente, Os nossos dados de contacto são os seguintes:

 0034-931294512

 info@aosom.pt.

IMPORTADOR/Fabricante/REP:
SPANISH AOSOM, S.L.
C.ROC GROS N.15, 08550. ELS HOSTALETES DE
BALENYÀ
FEITO NA CHINA



FR

**DONNEZ
OU
RECYCLEZ**



ASSOCIATION

OU



LIVRAISON

OU



DÉCHÈTERIE

Adresses sur quefairedemesdechets.fr