

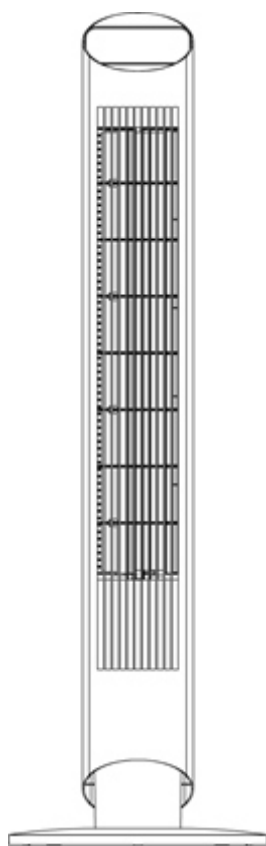

IN251000379V01_UK

824-146V70



Tower Fan

220-240V~50-60Hz 45W

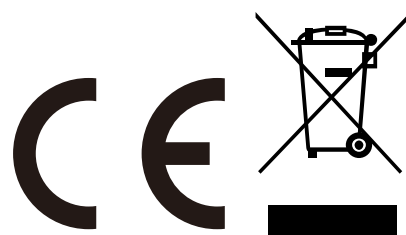

IMPORTANT, RETAIN FOR FUTURE REFERENCE: READ CAREFULLY.

READ CAREFULLY BEFORE ATTEMPTING TO ASSEMBLE, INSTALL, OPERATE OR MAINTAIN THE PRODUCT DESCRIBED. PROTECT YOURSELF AND OTHER BY OBSERVING ALL SAFETY INFORMATION. FAILURE TO COMPLY WITH INSTRUCTIONS COULD RESULT IN PERSONAL INJURY AND/OR PROPERTY DAMAGE !

IMPORTANT SAFETY INSTRUCTIONS

- Read all instructions carefully before using the FAN.
- This appliance can be used by children aged from 8 years and above and persons with reduced physical, sensory or mental capabilities or lack of experience and knowledge if they have been given supervision or instruction concerning use of the appliance in a safe way and understand the hazards involved.
- Children shall not play with the appliance.
- Cleaning and user maintenance shall not be made by children without supervision.
- If the supply cord is damaged, it must be replaced by the manufacturer, its service agent or similarly qualified persons in order to avoid a hazard.
- Use this FAN only as described in this manual. Any other use not recommended by the manufacturer may cause fire, electrical shock, or injury to persons.
- Remove the package and ensure that the FAN is undamaged. In case of doubt do not use FAN and contact with your supplier.
- Do not let children play parts of package.
- Before use the FAN, check if the voltage marked on the rating label corresponds to the mains in your home.
- Extreme caution is necessary when the FAN is used by or near children or Invalids and whenever the FAN is left operating unattended.
- Avoid using extension cord as the extension cord may overheat and cause a risk of fire.
- Do not pull the power cord to disconnect with power source. Always grasp the plug to pull out.
- Do not insert any objects into the FAN as it may cause an electric shock or injure or damage to the FAN. Do not block or tamper with the FAN in any manner while it is in operation.
- Do not leave the FAN unattended.
- This FAN is not intended for use in wet or damp locations. Never locate a FAN where it may fall into a bathtub or other water container.
- Do not use FAN outdoors.
- Disconnect the fan from the mains power when not in use, and before servicing or performing any maintenance.
- **WARNING:** The Main Power Switch and the On/Off switch should not be used as the sole means of disconnecting power. Always unplug the power cord before servicing or moving the unit.
- Keep the fan clean and maintain in good condition (use an authorized service agent).

- Use recommended parts only (non genuine parts may be dangerous, and will invalidate your warranty).
- When not in use store in a safe, dry, childproof location.
- The back housing shall not dismantle, removal will be dangerous .
- **WARNING:** To avoid danger of electric shock, unplug from outlet when not in use and before cleaning.

PARTS NAME

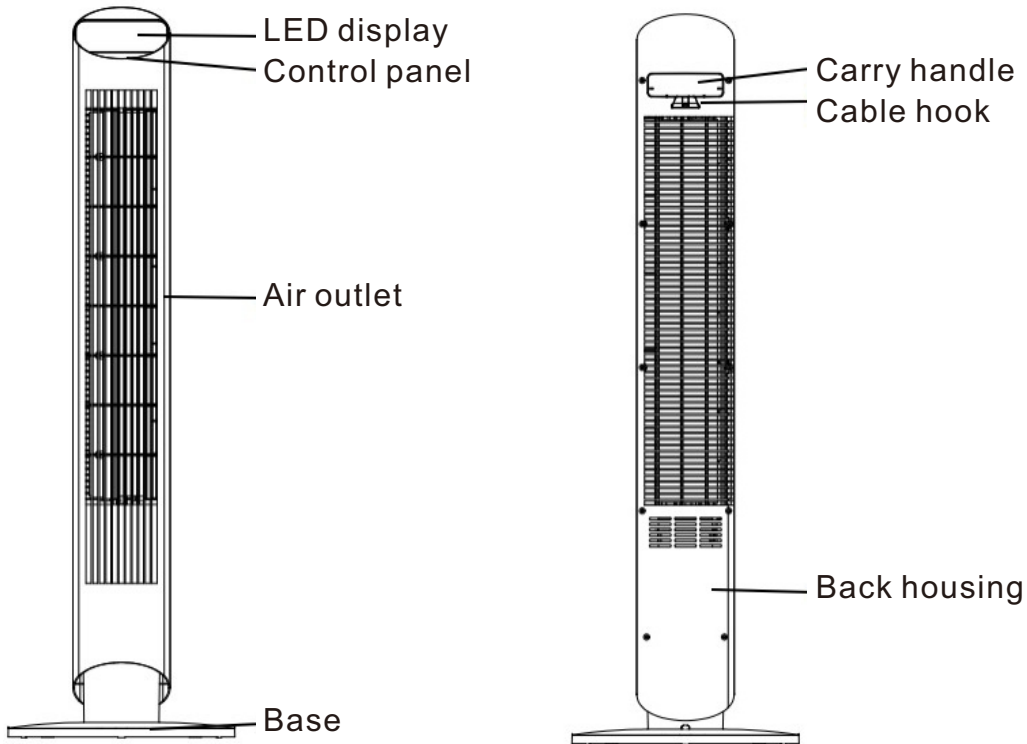

FAN BASE ASSEMBLY

1. Take out the two parts of the base from packing box. Then, align the centers of the two parts of the base and place them in a crossed form. Rotate one of the two bases to align its hole site and make it stuck correctly. (Fig 1)

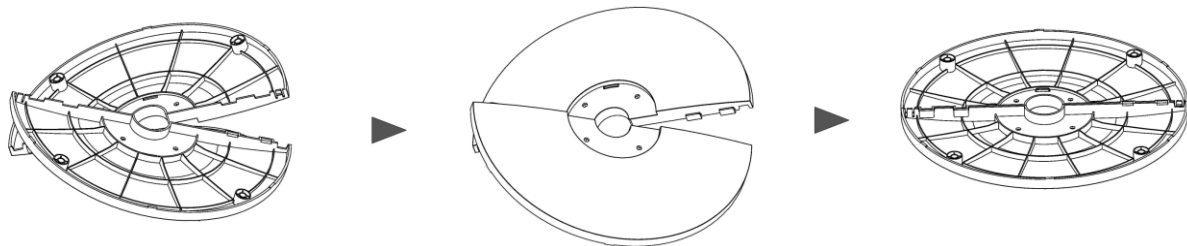

(Fig 1)

- Put the wire in the recess, then fix the base on the fan body with four screws (included), and turn the screws clockwise. (Fig 2)

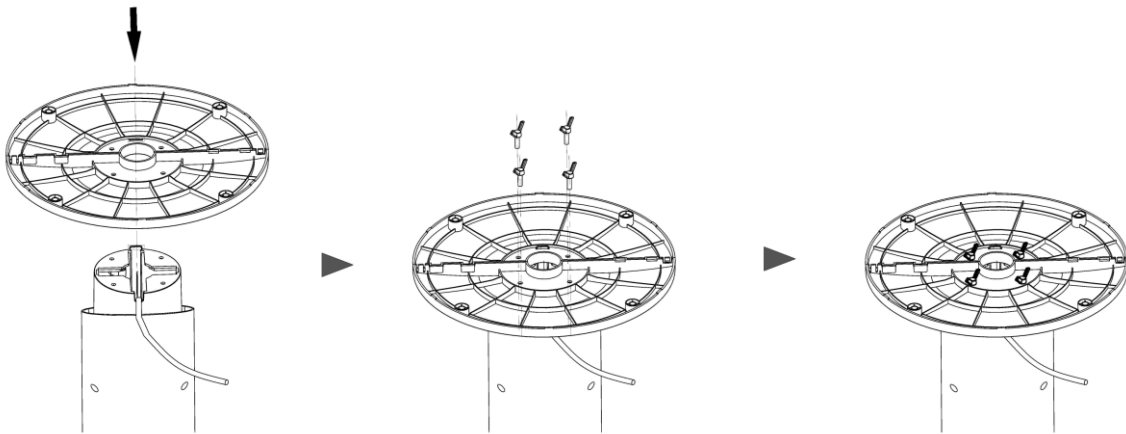

(Fig 2)

REMOTE CONTROL

- Install 2*AAA batteries (Not included) into the remote.
- The remote control button are labeled as such(Fig 3). All the functions performed with the remote control work identically to the manual controls.

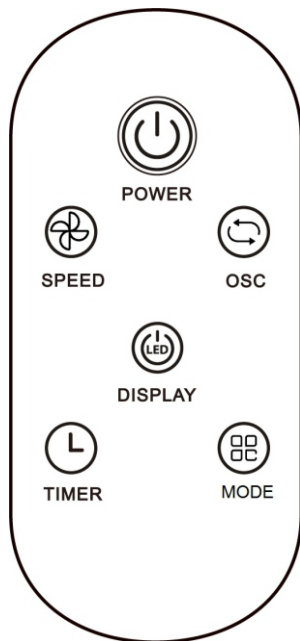



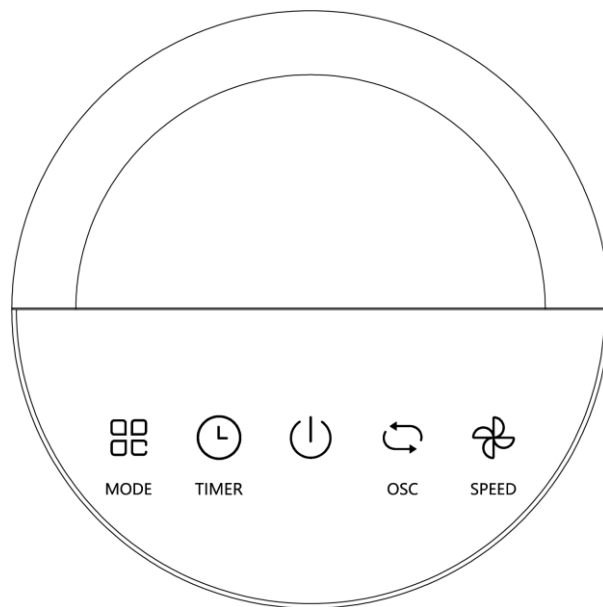













Remote control (Fig 3)



Top Control Panel (Fig 4)

OPERATION

The FAN may be operated by the manual controls located on the FAN (Fig 4) or by your remote control. (Fig 3)

1. Place the FAN on a stable flat surface. Plug the cord set into a 220-240V~ electrical outlet. Plug on the FAN, existing room temperature will be displayed at LED display.
2. **POWER**  : Turn the FAN on by pressing the  button; Turn the FAN off by pressing the  button again.
3. **SPEED**  : You can adjust the fan speed to the desired level: low, medium, or high by pressing 'SPEED'. The speed setting is displayed on the LED display. (Fig 5)
4. **MODE**  : Pressing the  button will set the FAN into NORMAL, NATURAL, SLEEP and CHILD mode.
 - **NORMAL Mode**  : The default mode is normal mode. Fan will start work at any speed you set up.
 - **NATURAL Mode**  : Fan will start work at speed 3(5s)→speed 4(5s)→speed 5(5s)→speed 6(5s)→speed 5(5s)→speed 4(5s), it works as per this recycle.
 - **SLEEP Mode**  : 1) If the fan is set at speed 4, 5 or 6, fan will work at the set speed for 30 mins, then fan speed will transfer to next lower level and work for 30 mins. If it comes to speed 3, it will keep working at speed 3 until you turn off the fan. If it is set in speed 3, it will only work at speed 3 until it is turned off. 2) If you set the speed at speed 1, 2 or 3, fan will work at speed 3 until the fan is turned off. The LED display will turn off if you don't control the fan in 30 seconds, touch any button to turn on the display.
 - **CHILD Mode**  : Fan will auto. set up timer at 3 hours and oscillation function and ionizer function will start. The fan will work at speed 6 for 15 minutes, and it will transfer to speed 4 for 15 minutes, then it will transfer to speed 2 for the rest 2.5 hours. You can turn off oscillation function and ionizer function manually. The LED display will turn off if you don't control the fan in 30 seconds, touch any button to turn on the display.
5. **TIMER**  : The fan is equipped with a timer that allows you to set its length of operation from 1 hour to 12 hours. The LED display will turn off if you don't control the fan in 30 seconds, touch any button to turn on the display.
6. **OSCILLATION**  : Pressing the  button will start and stop the oscillation function. The symbol is displayed on the LED display.
7. **DISPLAY**  : Can be switched off temporarily by pressing the  button on the remote or by pressing and holding the  button on the control panel for more than 3 seconds, the display will light up again once any control button is activated.

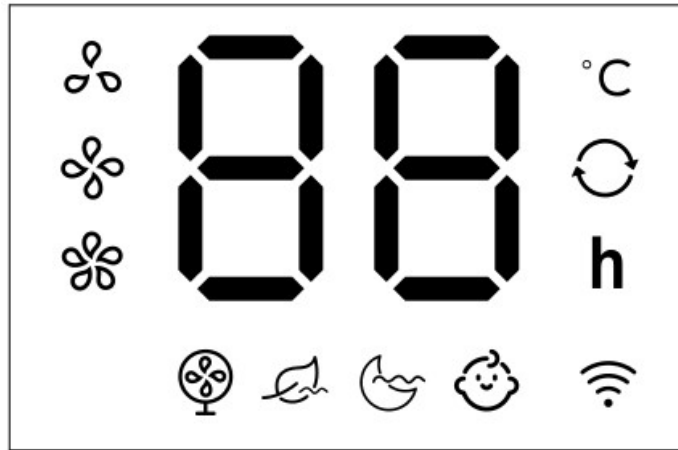

8. **CABLE HOOK:** The cable hook is packed in the user manual, take it out and install on the back side of the fan. The power cord can be hung at the cable hook when the fan is not used. (Fig 6)

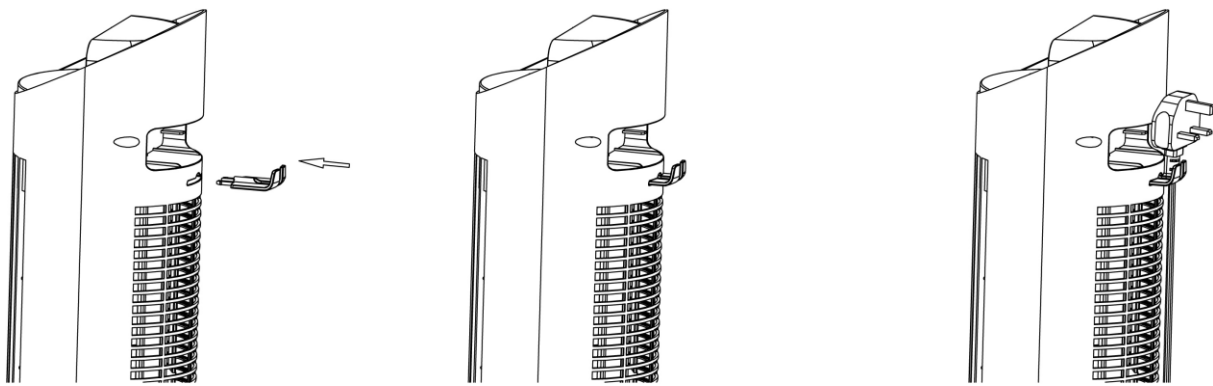

(Fig 6)

MAINTENANCE

1. This can only be done by an authorized service agent such as your local dealer or any agent qualified to undertake electrical repairs.
2. If the unit requires external cleaning make sure it is switched off and unplugged from the mains supply. Use a soft tissue or cloth for general cleaning. To remove more persistent dirt or grime wipe down with a cloth that has been dampened with warm soapy water. Do not use any solvents (such as thinners) as these may damage the plastic casing.

Correct Disposal of this product

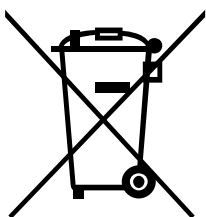

This marking indicates that this product should not be disposed with other household wastes throughout the EU. To prevent possible harm to the environment or human health from uncontrolled waste disposal, recycle it responsibly to promote the sustainable reuse of material resources. To return your used device, please use the return and collection systems or contact the retailer where the product was purchased. They can take this product for environmental safe recycling.

WiFi Operation manual-TuyaSmart App

1. Download “TuyaSmart” APP from the APP Store from your mobile phone or scan the right QR code to download.



2. After installation, click “Sign up”. Then, agree the privacy policy and user agreement.

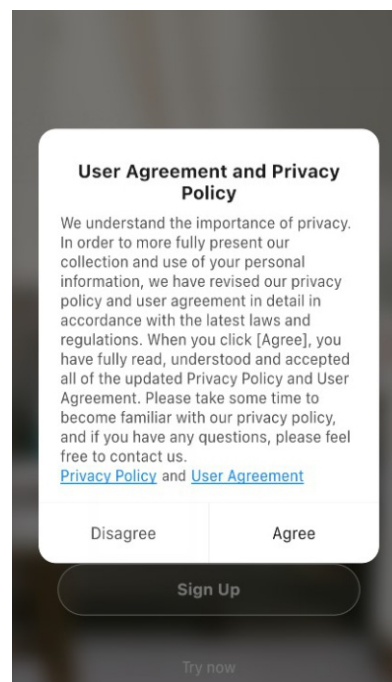
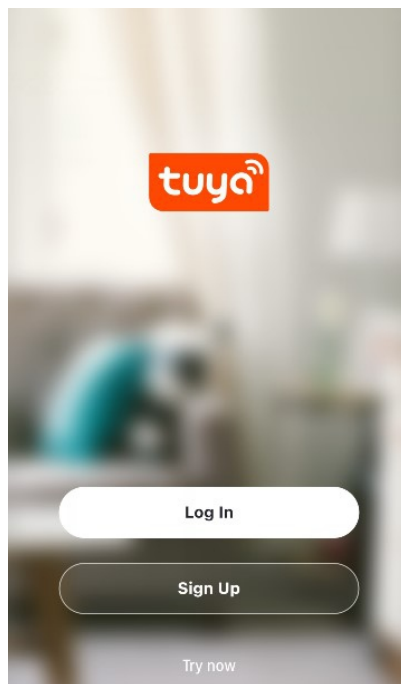

3. Register by entering the mobile number or email, then press "get verification code". Enter the verification code you receive, then you will need to Set Password. Click "Done" to complete it.

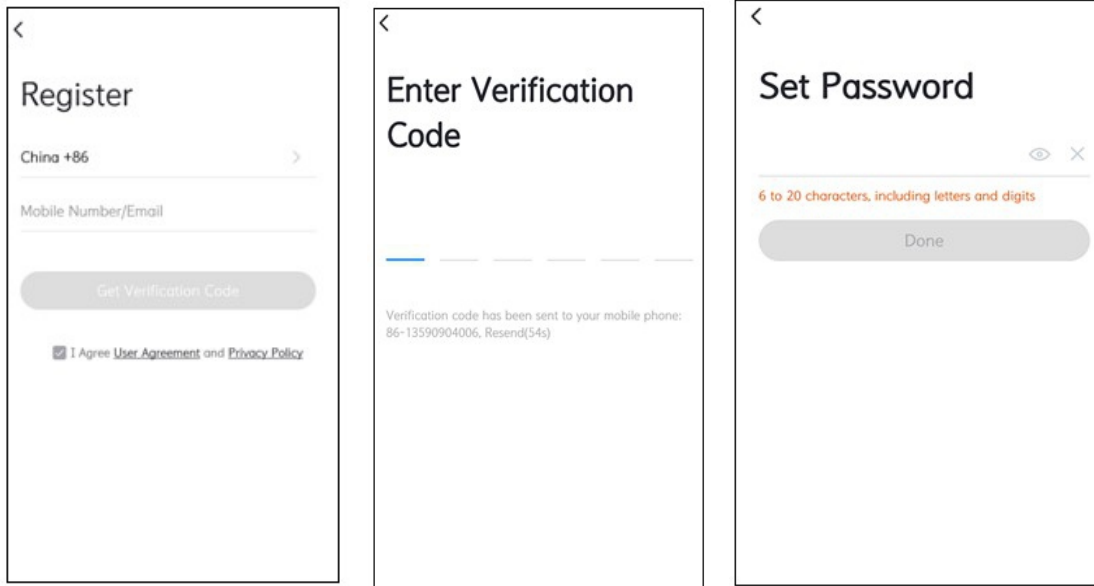

5. After login, it may remind you to add the fan, click "Go to add" and add the device automatically as the following left picture. (If the APP does not remind to add the fan, it can be added manually by clicking "Add Device" icon or clicking + icon at the top right corner. Go to "Small Home Appliances" and select "Fan".)

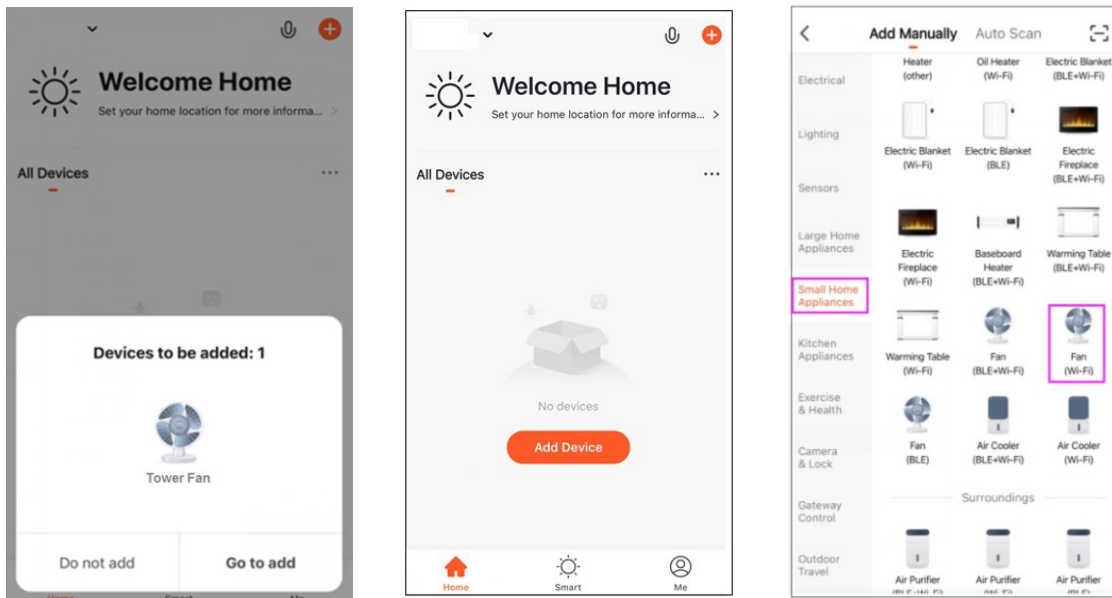

NOTE:When the WiFi Symbol  flashes on the LED display. The fan will be ready to connect. If no WiFi icon appears, hold and long press the oscillation button on the control panel for 5 seconds in standby mode.

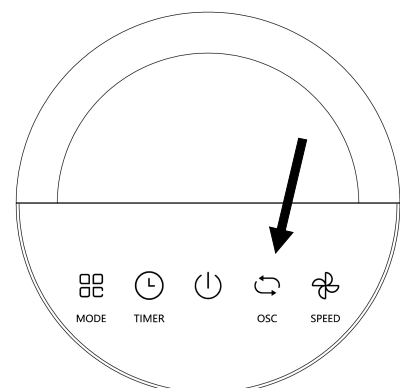

5. This APP is supported only on 2.4GHz Wi-Fi network. Please ensure your phone is 2.4GHz capable. (Note: this device will only work within your home WiFi system. This does not operate on 3G, 4G or 5G internet connections.)

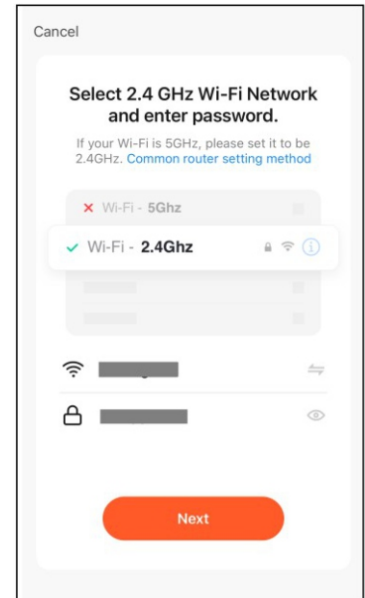

6. Select the correct option at the right top corner. WiFi symbol can be changed to blink fast or slowly by hold and long press the OSCILLATION button on control panel of the fan.

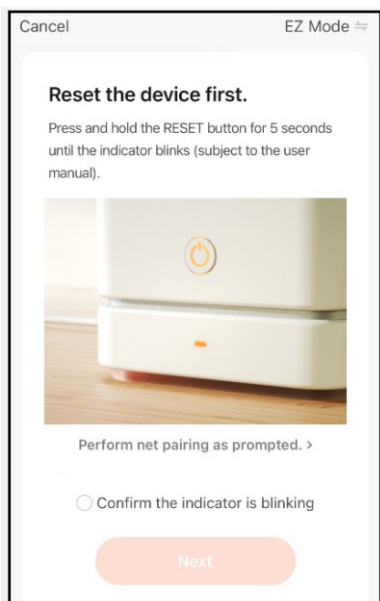

WiFi symbol blinks fast

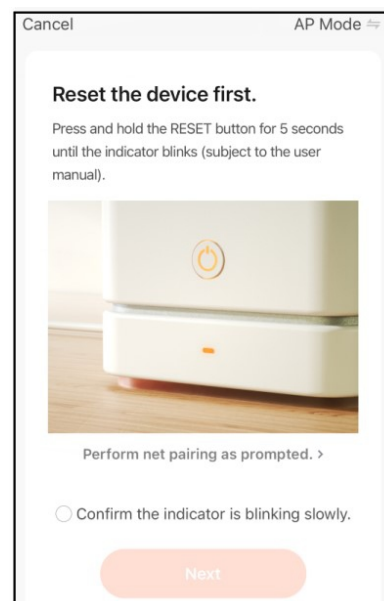

WiFi symbol blinks slowly

7. After adding successfully, go “Next”.

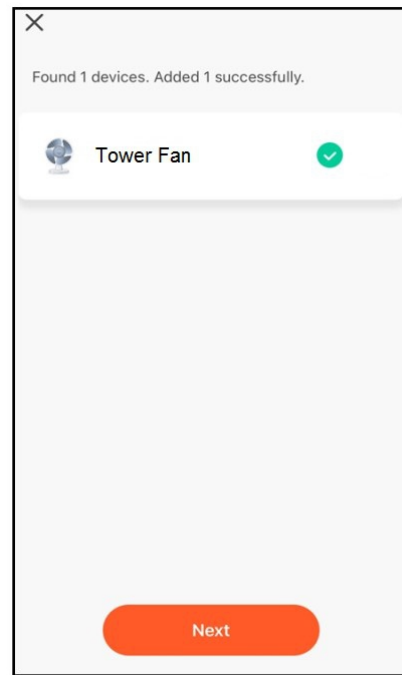
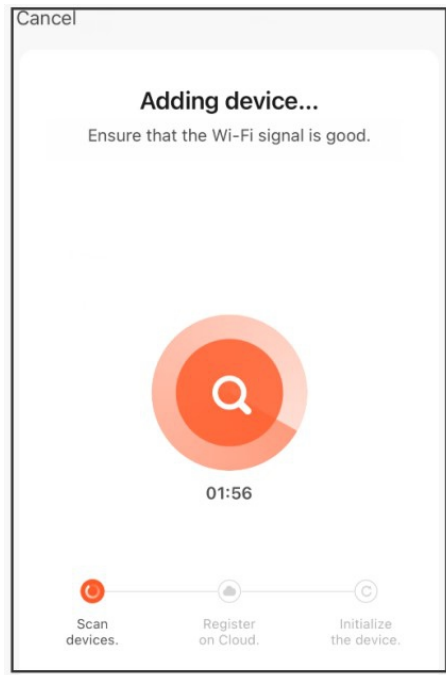

8. After connecting successfully, the WiFi symbol on the LED display will stop blinking. It may disappear for a second, and then will be always on.

9. Tap “Switch” at the left bottom, the fan Fig. 1 will be turned on as Fig. 2. Fan speed can be adjusted to Speed 1 to Speed 6 by touching the bar. Oscillation function will be started or stopped by pressing the Oscillation icon in Fig. 3.

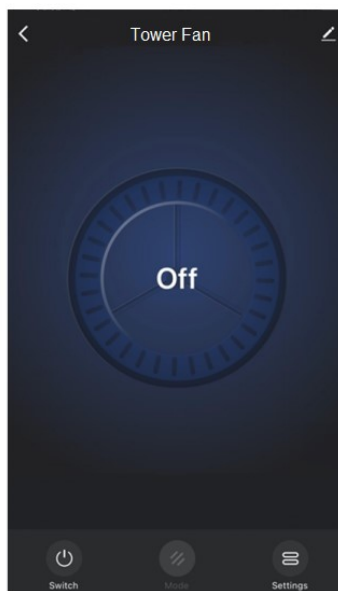

(Figure 1)

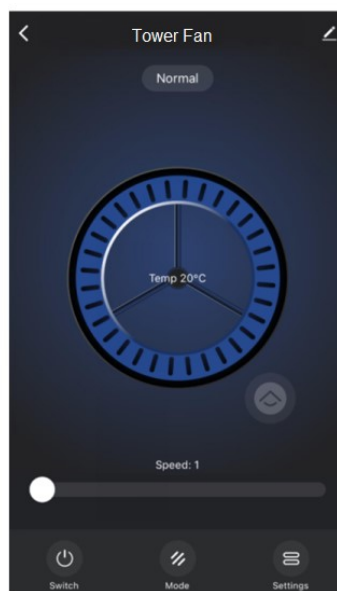

(Figure 2)



(Figure 3)

10. Press “Mode”, you will be able to choose Normal, Natural, Sleep and Child mode, and it will be shown accordingly at the top. Touch “Setting” in the right bottom, Timer and Display functions can be operated.

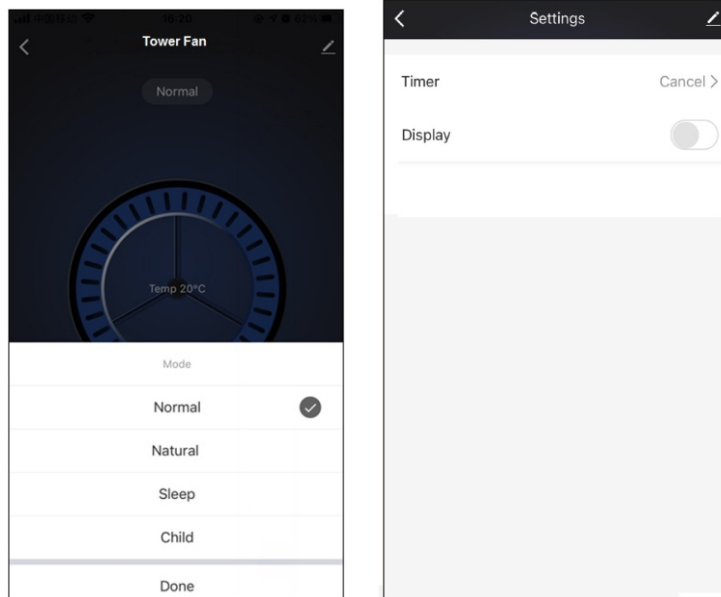

If you have any questions, please contact our customer care center.
Our contact details are below:



0044-800-240-4004



enquiries@mhstar.co.uk

IMPORTER ADDRESS:
MH STAR UK LTD
Unit 27, Perivale Park,
Horsenden lane South
Perivale, UB6 7RH
MADE IN CHINA

