

EN_IMPORTANT, RETAIN FOR FUTURE REFERENCE: READ CAREFULLY.
 FR_IMPORTANT: A LIRE ATTENTIVEMENT ET A CONSERVER POUR VOUS Y REFRERER
 ULTERIEUREMENT
 ES_IMPORTANTE, LEA DETENIDAMENTE Y GUARDE PARA FUTURAS REFERENCIAS.
 PT_IMPORTANTE, GUARDE PARA FUTURA REFERÊNCIA, LEIA ATENTAMENTE.
 DE_WICHTIG! SORFGFÄLTIG LESEN UND FÜR SPÄTERES NACHSCHLAGEN AUFBEWAHREN.
 IT_IMPORTANTE, LEGGERE E CONSERVARE QUESTO MANUALE D'ISTRUZIONE PER UN USO
 FUTURO.

EN Operation Instructions

- Please confirm that all components are present before beginning assembly.
- Place all parts on a clean and smooth surface to prevent any damage.
- Do not fully tighten any screws until all screws have been initially tightened. This could cause the frame to warp.
- If wobbling persists or screw holes fail to align, loosen the screws and tighten them sequentially.

FR Instructions pratiques

- Avant de commencer l'assemblage, veuillez confirmer que tous les composants sont présents.
- Placez toutes les pièces sur une surface propre et lisse de manière à éviter tout dommage.
- Ne serrez complètement aucune vis tant que toutes les vis n'ont pas été serrées initialement. Cela pourrait déformer le cadre.
- Si des oscillations persistent ou si les trous de vis ne s'alignent pas, desserrez les vis et serrez-les séquentiellement.

ES Instrucciones de operación

- Por favor, confirme que todos los componentes están presentes antes de comenzar el ensamblaje.
- Coloque todas las piezas sobre una superficie limpia y lisa para evitar daños.
- No apriete completamente ningún tornillo hasta que todos los tornillos hayan sido apretados inicialmente. Esto podría deformar el armazón.
- Si persisten balanceos o los orificios de los tornillos no se alinean, afloje los tornillos y apriéte-los secuencialmente.

PT Instruções de funcionamento

- Por favor, confirme que todos os componentes estão presentes antes de começar a montagem.
- Coloque todas as peças numa superfície limpa e lisa para evitar danos.
- Não aperte completamente nenhum parafuso até que todos os parafusos tenham sido apertados inicialmente. Isso pode deformar a estrutura.
- Se houver oscilações persistentes ou os furos dos parafusos não se alinharem, afrouxe os parafusos e aperte-os sequencialmente.

DE Betriebsanleitung

- Bitte bestätigen Sie, dass alle Komponenten vor Beginn der Montage vorhanden sind.
- Legen Sie alle Teile auf eine saubere und ebene Fläche, um Beschädigungen zu vermeiden.
- Ziehen Sie keine Schrauben vollständig an, bis alle Schrauben zunächst angezogen wurden. Dies könnte den Rahmen verziehen.
- Falls Wackeln anhält oder Schraubenlöcher nicht ausgerichtet sind, lockern Sie die Schrauben und ziehen Sie sie nacheinander an.

IT Istruzioni per l'uso

- Prima di iniziare l'assemblaggio, confermare che tutti i componenti siano presenti.
- Posiziona tutte le parti su una superficie pulita e liscia per evitare danni.
- Non stringere completamente alcuna vite finché tutte le viti non sono state avvitate inizialmente. Ciò potrebbe deformare il telaio.
- Se persistono oscillazioni o i fori delle viti non si allineano, allentare le viti e stringerle sequenzialmente.

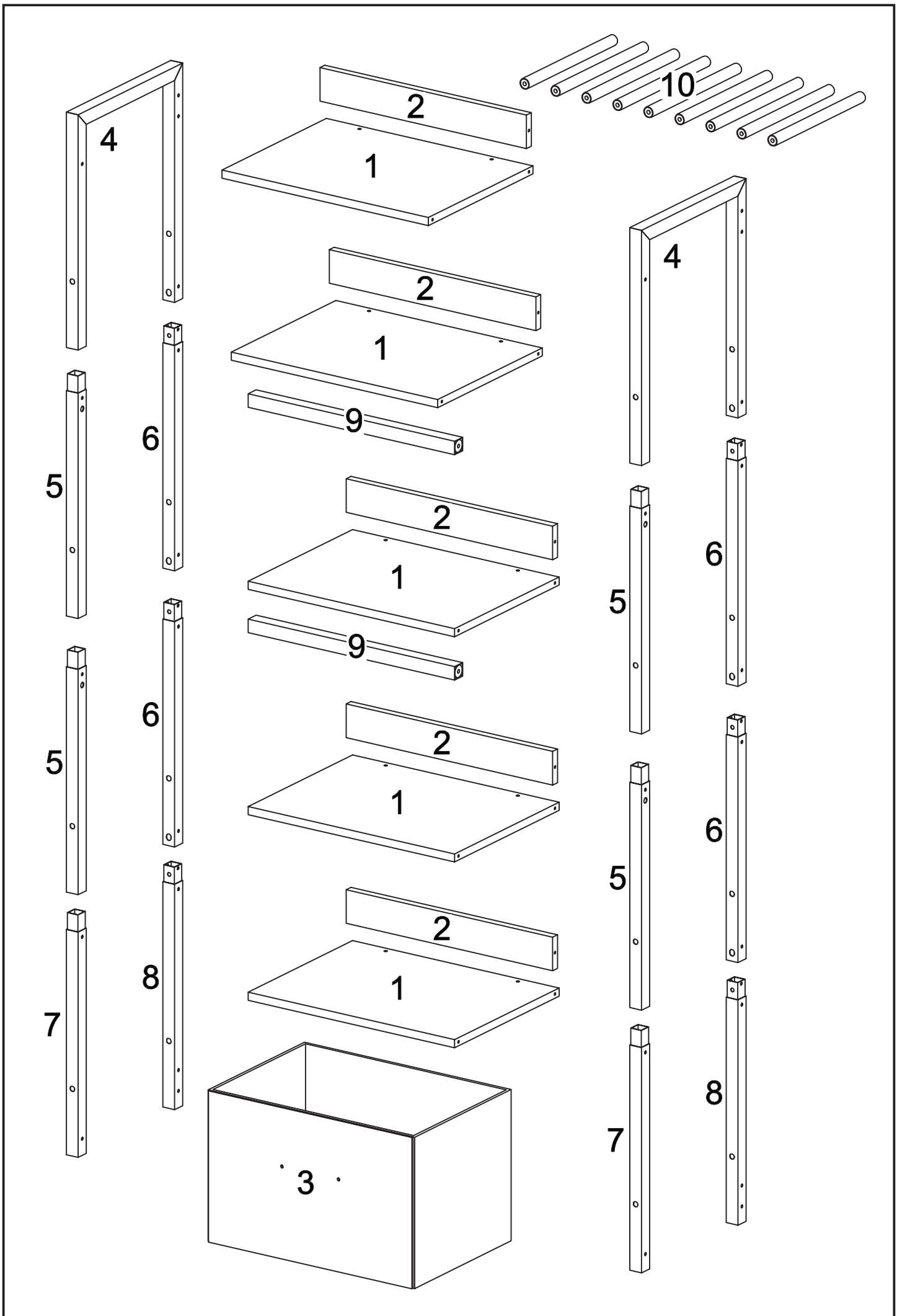

1

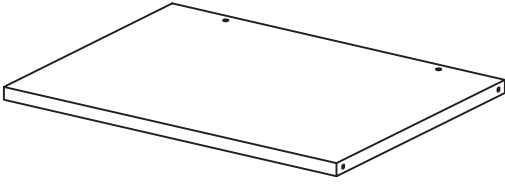

x5

350×260×12mm

2

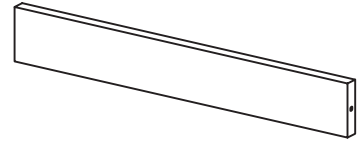

x5

350×50×12mm

3

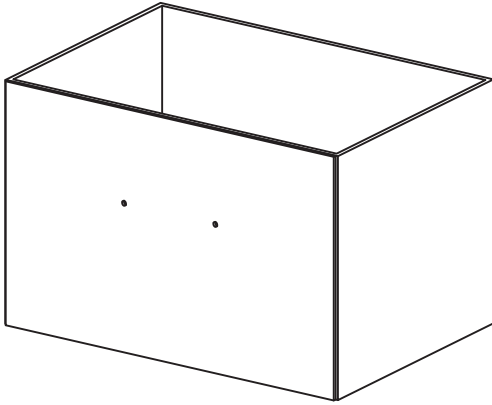

340×245×275mm

4

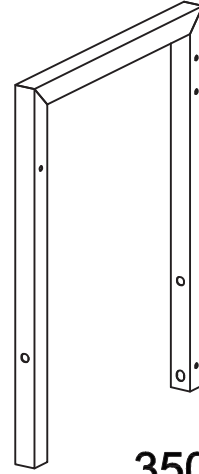

x2

350×260×20mm

5



x4

360×20×20mm

6



x4

360×20×20mm

7



x2

360×20×20mm

8



x2

360×20×20mm

9

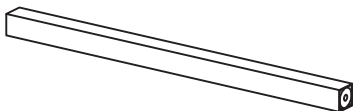

x2







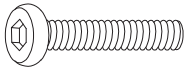
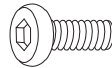
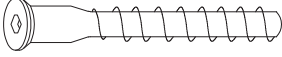

350×20×20mm

10

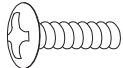

x8

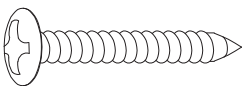
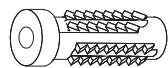
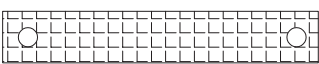
Ø $\frac{5}{8}$ "×0.7×220mm

<p>A x20 +2(spare)</p>  <p style="text-align: center;">M6x30mm</p>	<p>B x12 +1(spare)</p>  <p style="text-align: center;">M6x12mm</p>
<p>C x40 +4(spare)</p>  <p style="text-align: center;">Ø5.0x40mm</p>	<p>D x4</p>  <p style="text-align: center;">Ø20mm</p>
<p>E x2</p>  <p style="text-align: center;">M4x12mm</p>	<p>F x2</p>  <p style="text-align: center;">Ø10xØ5.2x0.8mm</p>
<p>G x1</p>  <p style="text-align: center;">M4x55mm M3x55mm</p>	<p>H x8</p> 
<p>J x2</p>  <p style="text-align: center;">Ø4x30mm</p>	<p>K x2</p>  <p style="text-align: center;">Ø6x30mm</p>
<p>L x2</p>  <p style="text-align: center;">25x120mm</p>	<p>M x1</p> 

x2Pcs

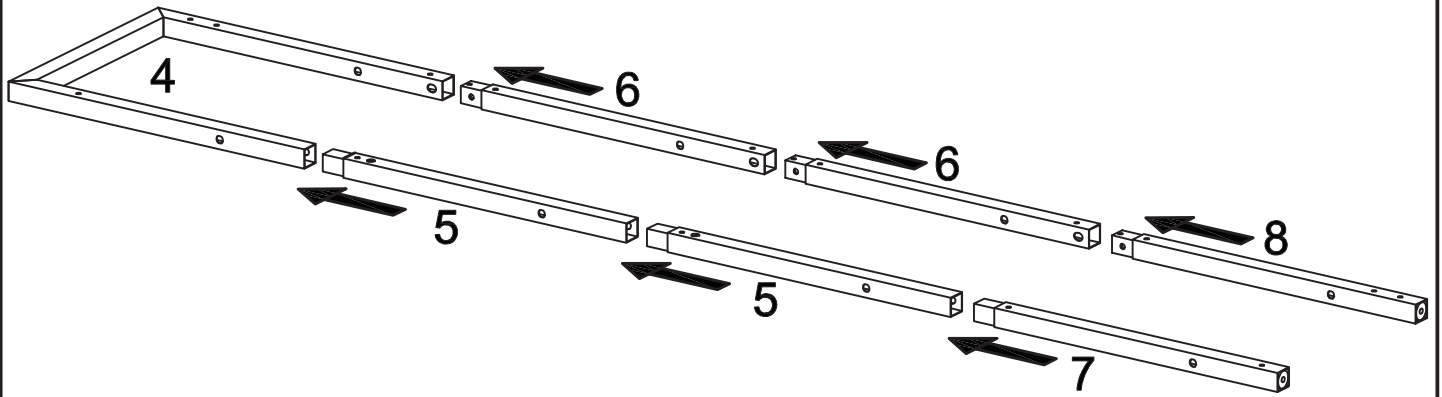

x2Pcs

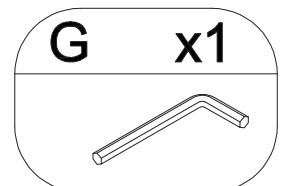
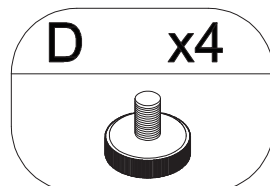
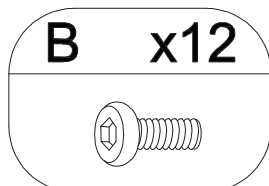
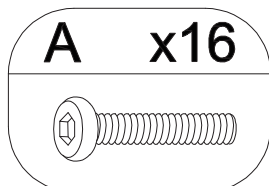
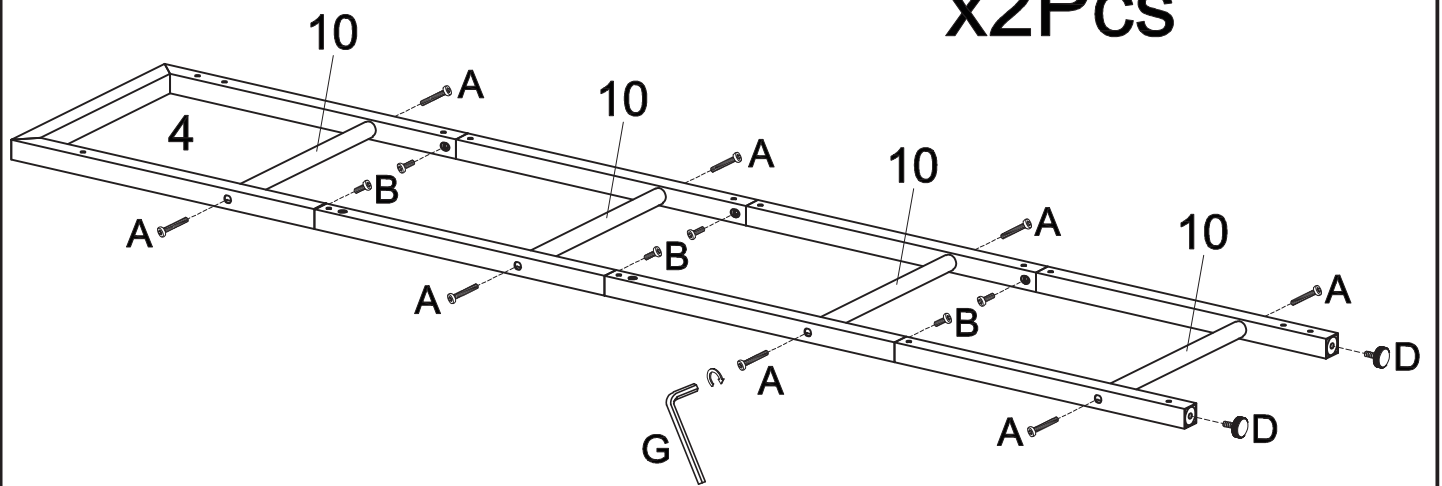

x5Pcs

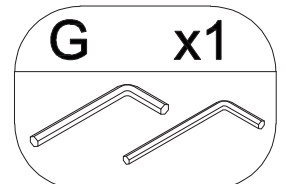
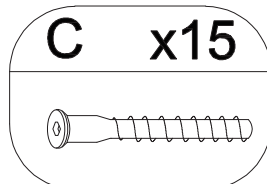
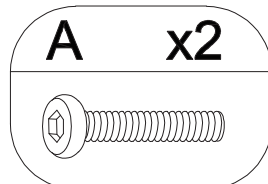
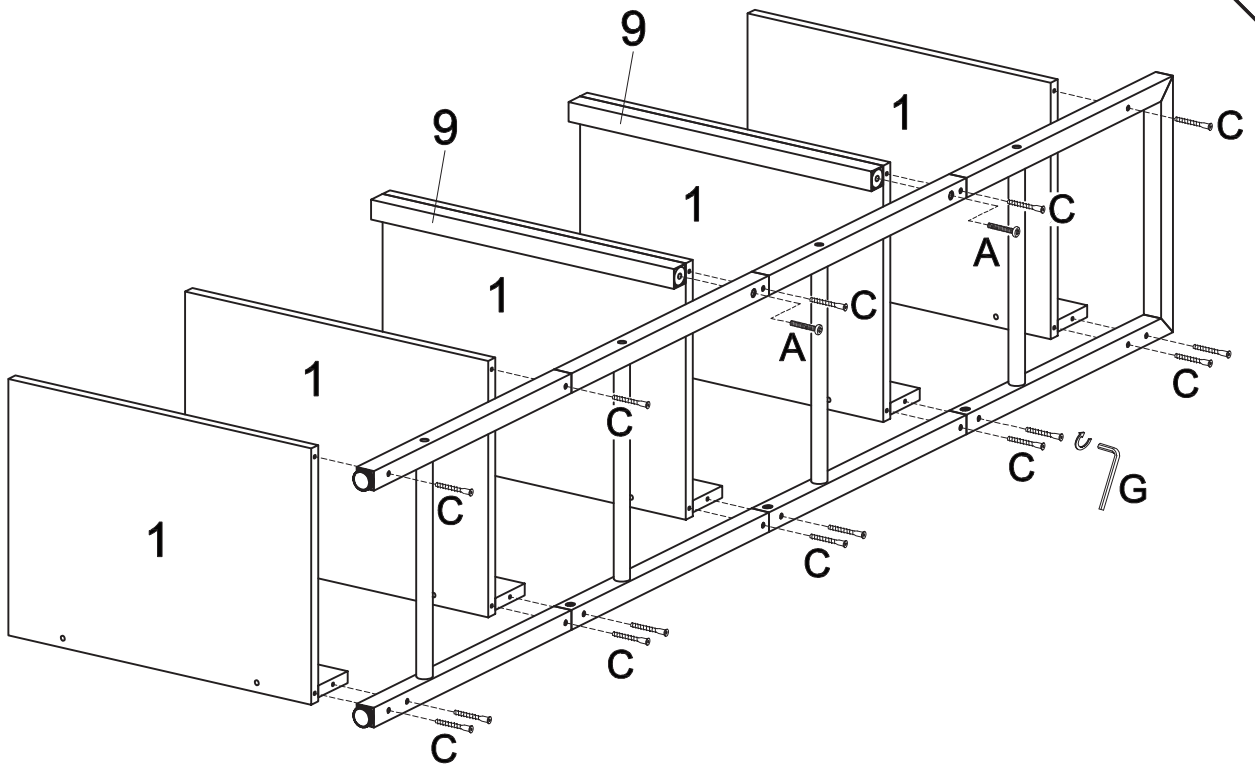
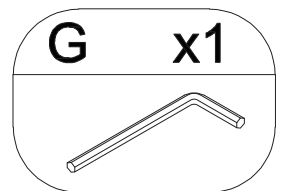
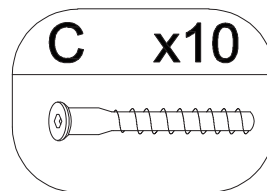
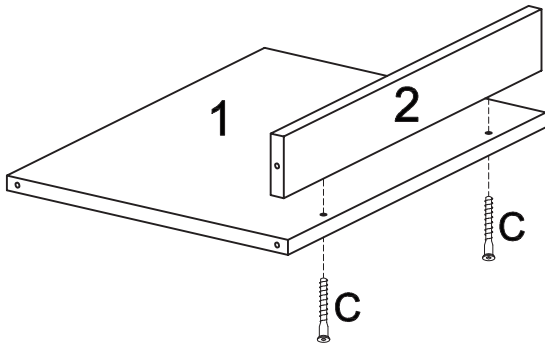

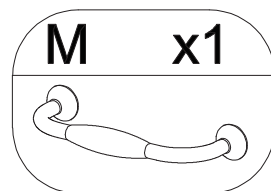
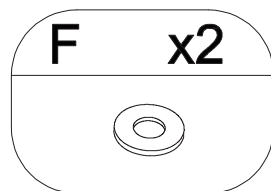
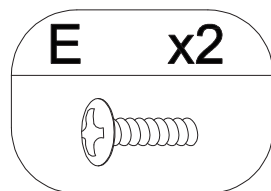
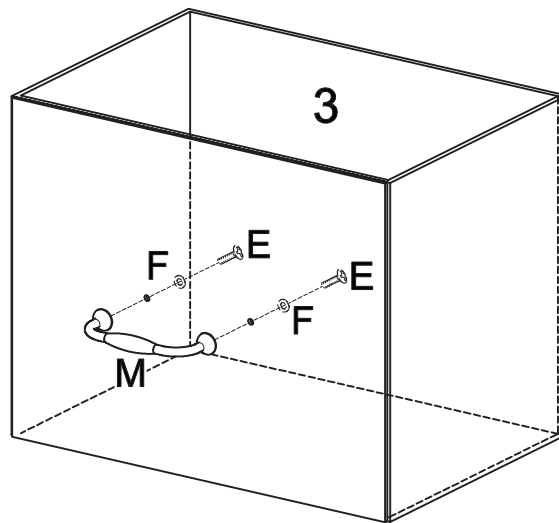
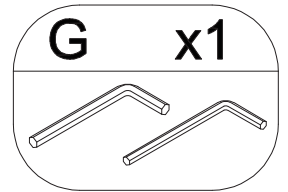
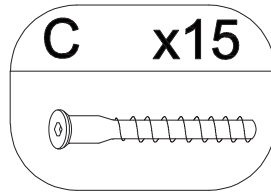
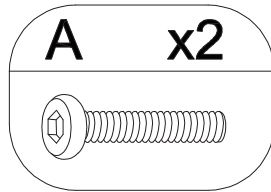
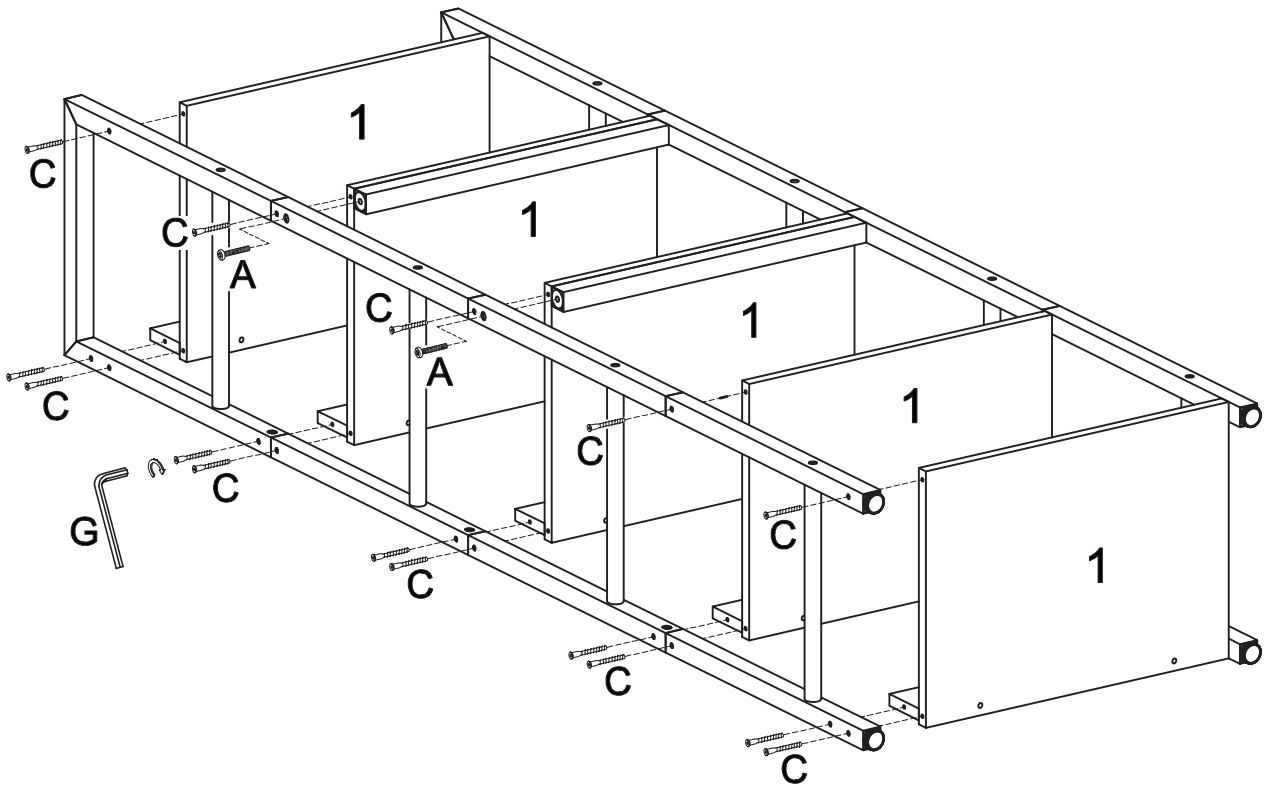

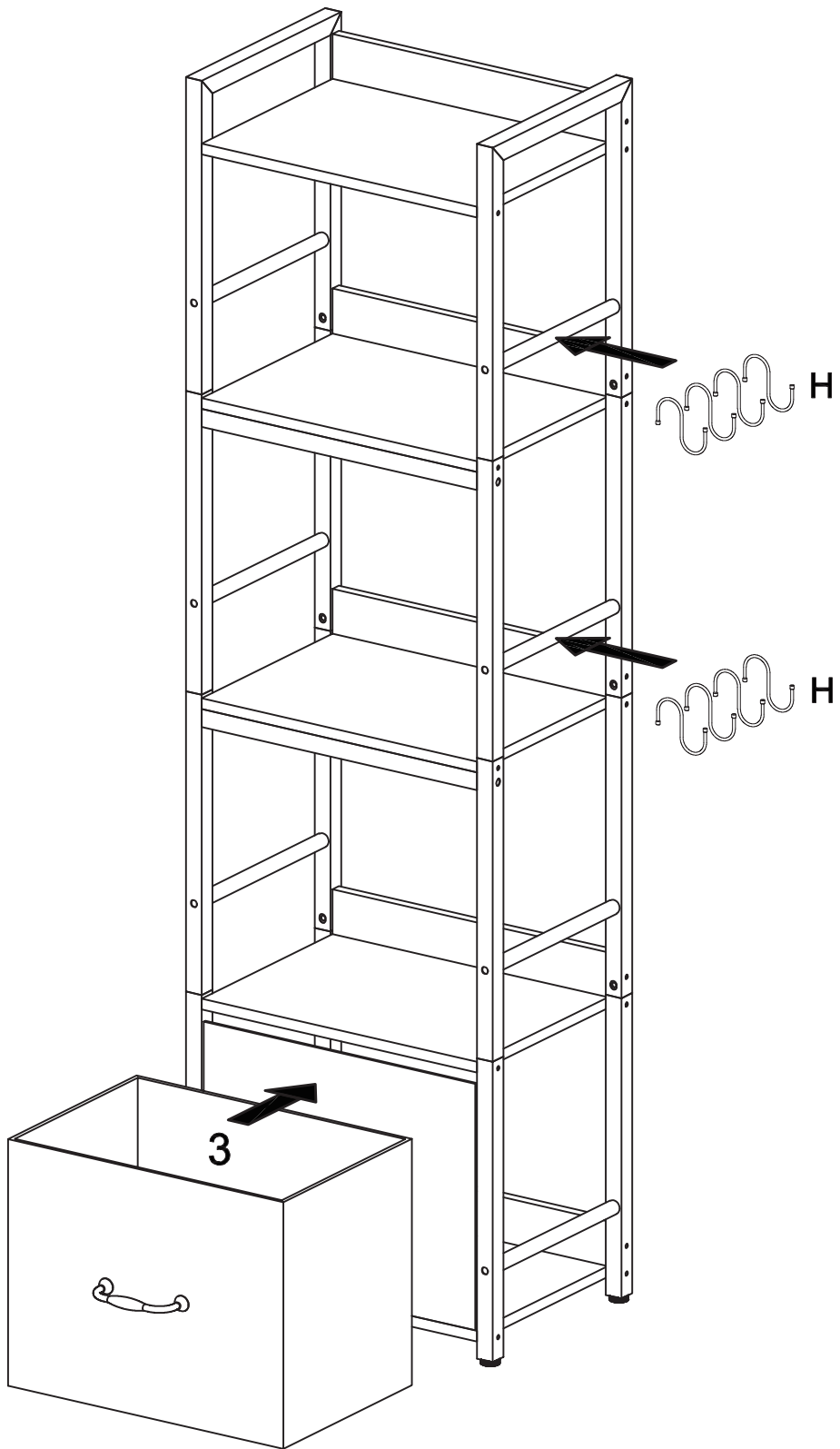

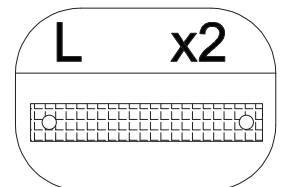
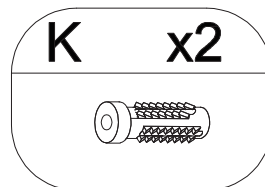
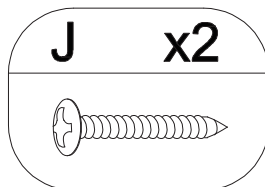
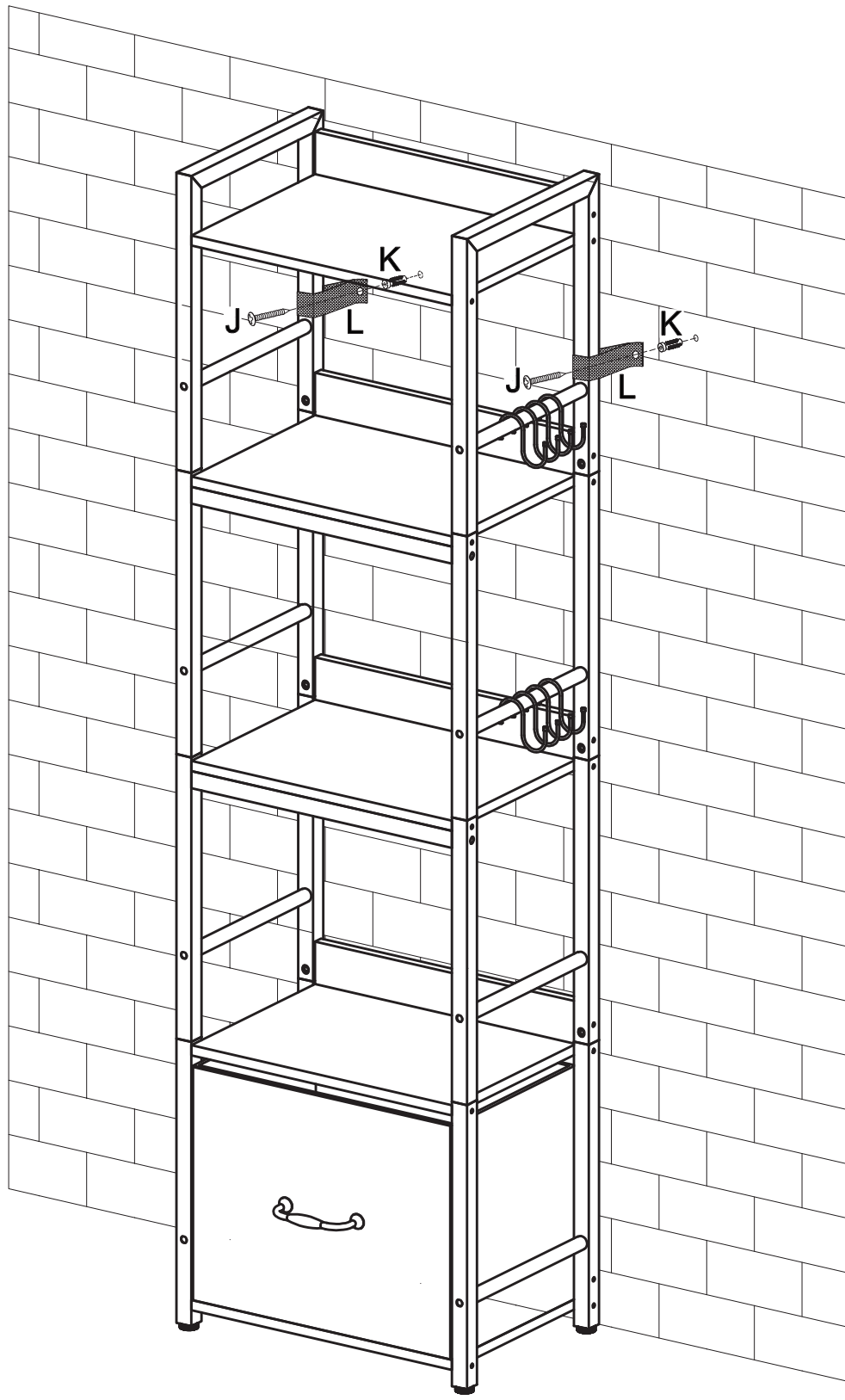

H x8

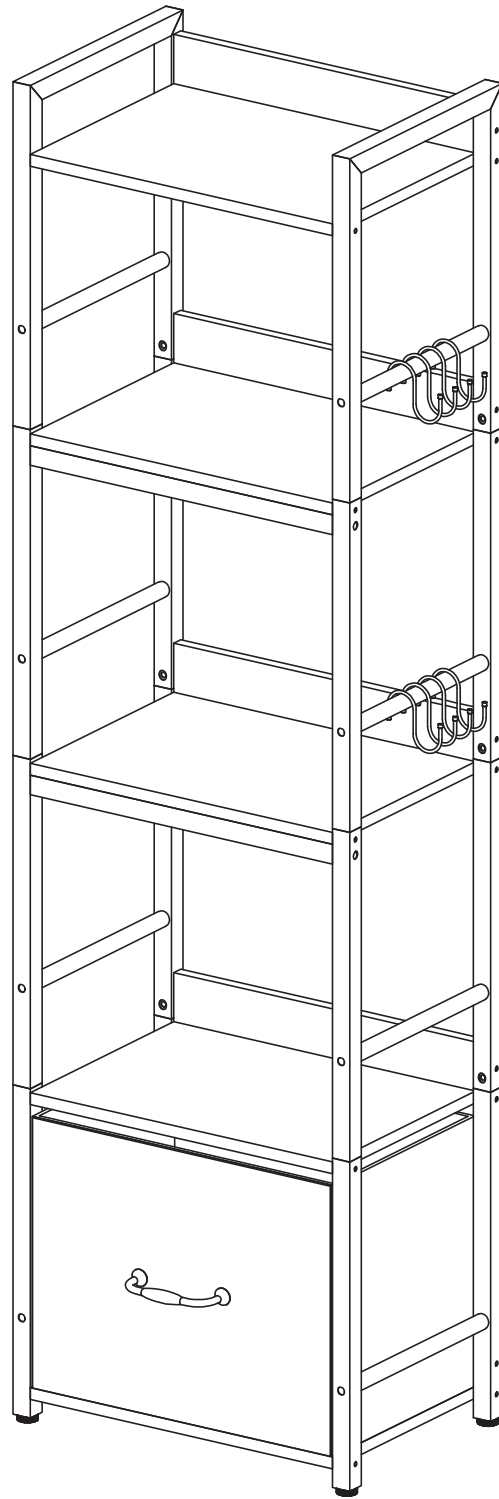



If you have any questions, please contact our customer care center, Our contact details are below:

US

 001-877-644-9366

 customerservice@aosom.com

Imported by Aosom LLC
27150 SW Kinsman Rd Wilsonville, OR 97070 USA
MADE IN CHINA

If you have any questions, please contact our customer care center, Our contact details are below:

CA

 416-792-6088

 customerservice@aosom.ca

Imported by Aosom Canada Inc.
7270 Woodbine Avenue, Unit 307, Markham,
Ontario Canada L3R 4B9
MADE IN CHINA

Si vous avez la moindre question, veuillez contacter notre centre d'assistance à la clientèle, Nos coordonnées sont les suivantes:

 416-792-6088

 customerservice@aosom.ca

Importé par Aosom Canada Inc.
7270 Woodbine Avenue, unité 307,
Markham, Ontario Canada L3R 4B9
FABRIQUÉ EN CHINE

If you have any questions, please contact our customer care center, Our contact details are below:

UK

 0044-800-240-4004

 enquiries@mhstar.co.uk

IMPORTER ADDRESS:
MH STAR UK Ltd
1 Northampton Cross Logistics Park
Northampton Cross Road
Northampton
NN4 9FH
MADE IN CHINA

Si vous avez la moindre question, veuillez contacter notre centre d'assistance à la clientèle, Nos coordonnées sont les suivantes:

FR

 0033-1-84166106

 aosom@mhfrance.fr

Importé par/Fabricant/REP:
MH FRANCE
2 Rue Maurice Hartmann
92130 Issy Les Moulineaux
France
FABRIQUÉ EN CHINE

Wenn Sie Fragen haben, wenden Sie sich bitte an unser Kundendienstzentrum, Unsere Kontaktdaten stehen unten:

DE

 +49 40 87408465

 service@aosom.de

ADRESSE DES IMPORTEUR/Hersteller/REP:
MH Handel GmbH
Wendenstraße 309
D-20537 Hamburg
Germany
IN CHINA HERGESTELLT

In caso di dubbio, si prega di contattare il nostro centro assistenza clienti, I nostri dettagli di contatto sono di seguito:

IT

 0039-0249471447

 clienti@aosom.it

IMPORTATO DA/Produttore/REP:
AOSOM Italy srl
Centro Direzionale Milanofiori
Strada 1 Palazzo F1
20057 Assago (MI)
P.I.: 08567220960
FATTO IN CINA

Si tiene alguna pregunta, comuníquese con nuestro Centro de Atención al Cliente, Nuestros datos de contacto son los siguientes:

ES

 0034-931294512

 atencioncliente@aosom.es

IMPORTADOR/Fabricante/REP:
SPANISH AOSOM, S.L.
C/ROC GROS, N°15.08550, ELS HOSTALETES DE
BALENYÀ, SPAIN.
B66295775
HECHO EN CHINA

Se tiver alguma dúvida, por favor contacte o nosso Centro de Atendimento ao Cliente, Os nossos dados de contacto são os seguintes:

 0034-931294512

 info@aosom.pt.

IMPORTADOR/Fabricante/REP:
SPANISH AOSOM, S.L.
C.ROC GROS N.15, 08550. ELS HOSTALETES DE
BALENYÀ
FEITO NA CHINA



FR

**DONNEZ
OU
RECYCLEZ**



ASSOCIATION

OU



LIVRAISON

OU



DÉCHÈTERIE

Adresses sur quefairedemesdechets.fr