

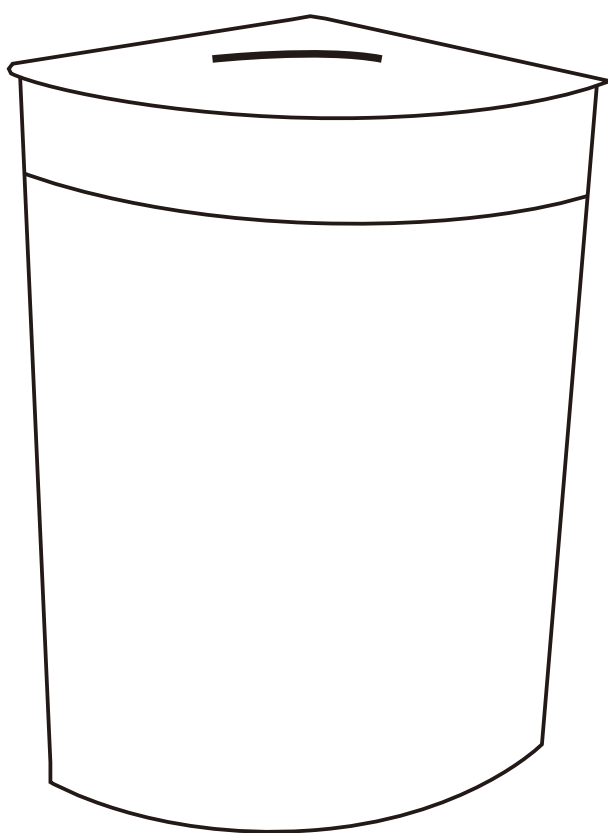

IN241200220V01_GL

850-346V00



EN_ IMPORTANT, RETAIN FOR FUTURE REFERENCE: READ CAREFULLY.

**FR_ IMPORTANT: A LIRE ATTENTIVEMENT ET À CONSERVER POUR CONSULTATION
ULTÉRIEURE.**

ES_ IMPORTANTE, LEA Y GUARDE PARA FUTURAS REFERENCIAS.

PT_ IMPORTANTE, RETER PARA REFERÊNCIA FUTURA: LEIA ATENTAMENTE.

DE_ WICHTIG! SORGFÄLTIG LESEN UND FÜR SPÄTER NACHSCHLAGEN AUFBEWAHREN.

**IT_ IMPORTANTE! CONSERVARE IL PRESENTE MANUALE PER FUTURO RIFERIMENTO E
LEggerlo ATTENTAMENTE.**

EN_Assembly steps:

- Please check whether all accessories are in good condition.
- Get hold of the handles and unfold the basket sheet into cuboid shape.
- Hold the cardboard base with the clasps of the bottom.
- Insert the metal ring and fasten it to stabilize the top.
- Place the liner bag and pull it around the outside.
- Get the lid on.

Notes:

- The handles are symmetrical at the center of both shorter sides.
- Pull the metal ring from the bottom to top.
- Do not store wet clothes inside, and keep the laundry basket away from humid place.

FR_Étapes d'assemblage :

- Vérifiez si tous les accessoires sont en bon état.
- Saisissez les poignées et dépliez la feuille du panier en forme de cube.
- Maintenez la base en carton à l'aide des fermoirs du fond.
- Insérez l'anneau métallique et fixez-le pour stabiliser le haut.
- Placez le sac de doublure et tirez-le autour de l'extérieur.
- Fixez le couvercle.

Notes :

- Les poignées sont symétriques au centre des deux côtés les plus courts.
- Tirez l'anneau métallique de bas en haut.
- Ne rangez pas de vêtements mouillés à l'intérieur, et gardez le panier à linge à l'écart des endroits humides.

ES_Pasos de montaje:

- Compruebe si todos los accesorios están en buen estado.
- Agarre las asas y despliegue la hoja de la cesta en forma de cubo.
- Sujete la base de cartón con los cierres de la parte inferior.
- Inserte el anillo metálico y sujételo para estabilizar la parte superior.
- Coloca la bolsa de forro y tira de ella alrededor del exterior.
- Coloca la tapa.

Notas:

- Las asas son simétricas en el centro de ambos lados más cortos.
- Tire de la anilla metálica desde abajo hacia arriba.
- No guarde ropa mojada dentro, y mantenga el cesto de la ropa lejos de lugares húmedos.

PT_Passos de montagem:

- Verificar se todos os acessórios estão em boas condições.
- Segure as pegas e desdobre a folha do cesto em forma de cuboide.
Segure a base de cartão com os fechos do fundo.
Inserir o anel de metal e fixá-lo para estabilizar a parte superior.
Colocar o saco de revestimento e puxá-lo à volta do exterior.
Colocar a tampa.

Notas:

- As pegas são simétricas no centro de ambos os lados mais curtos.
- Puxar o anel de metal de baixo para cima.
Não guarde roupa molhada no interior e mantenha o cesto da roupa longe de locais húmidos.

DE_Montageschritte:

- Bitte prüfen Sie, ob alle Zubehörteile in gutem Zustand sind.
Fassen Sie die Griffe an und klappen Sie den Korbbogen in Quaderform auf.
- Halten Sie den Kartonboden mit den Klammern des Bodens.
 - Setzen Sie den Metallring ein und befestigen Sie ihn, um den Deckel zu stabilisieren.
 - Den Innensack einlegen und außen herumziehen.
 - Den Deckel aufsetzen.

Hinweise:

- Die Griffe sind symmetrisch in der Mitte der beiden kürzeren Seiten.
 - Ziehen Sie den Metallring von unten nach oben.
- Bewahren Sie keine nassen Kleidungsstücke darin auf, und halten Sie den Wäschekorb von feuchten Orten fern.

IT_Fasi di montaggio:

- Controllare che tutti gli accessori siano in buone condizioni.
Afferrare le maniglie e dispiegare il foglio del cestino a forma di cubo.
Tenere la base di cartone con i ganci del fondo.
Inserire l'anello di metallo e fissarlo per stabilizzare la parte superiore.
Inserire il sacchetto di fodera e tirarlo intorno all'esterno.
Mettere il coperchio.

Note:

- I manici sono simmetrici al centro di entrambi i lati corti.
Tirare l'anello metallico dal basso verso l'alto.
Non riporre i capi bagnati all'interno e tenere il cesto della biancheria lontano da luoghi umidi.

A x 1

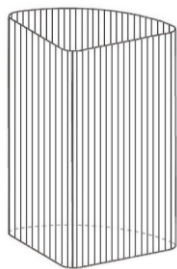

B x 1



C x 1



D x 1

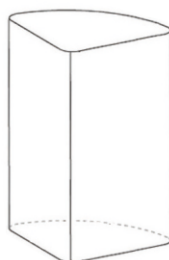

E x 1

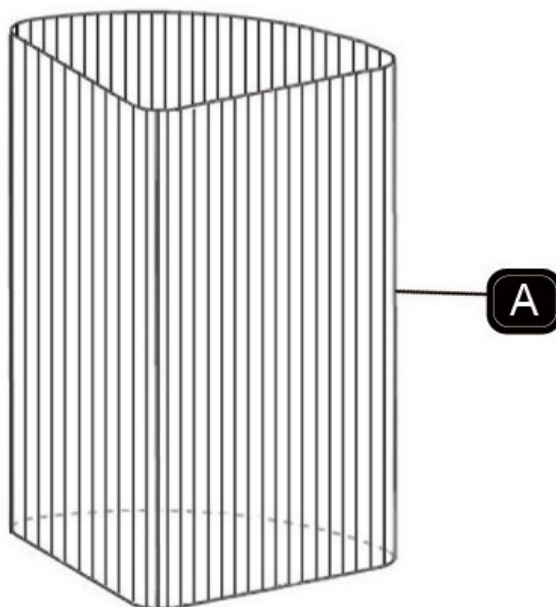
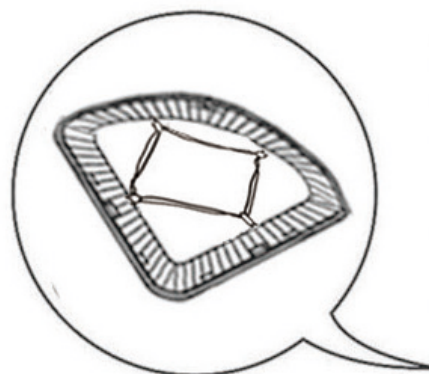
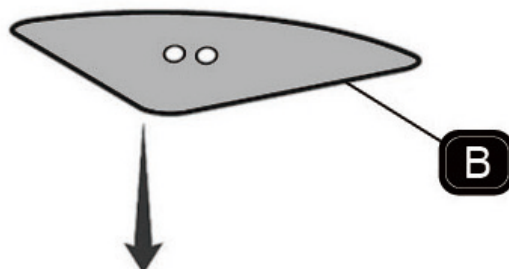

02

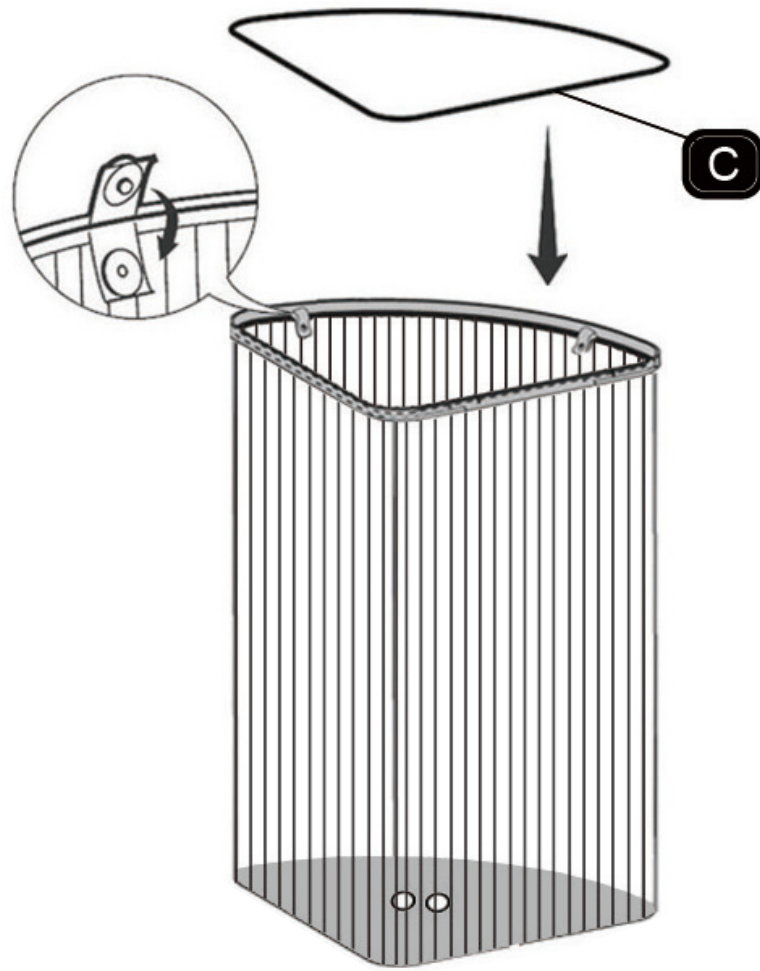

03

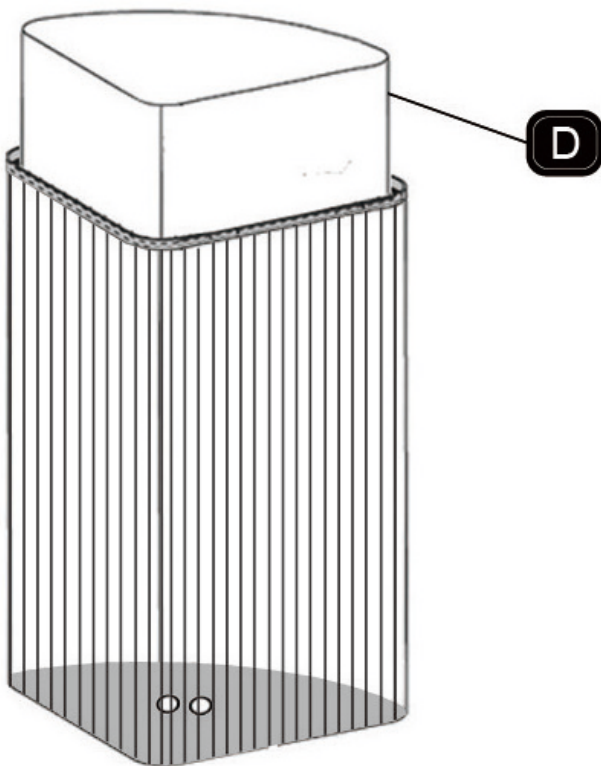

Done

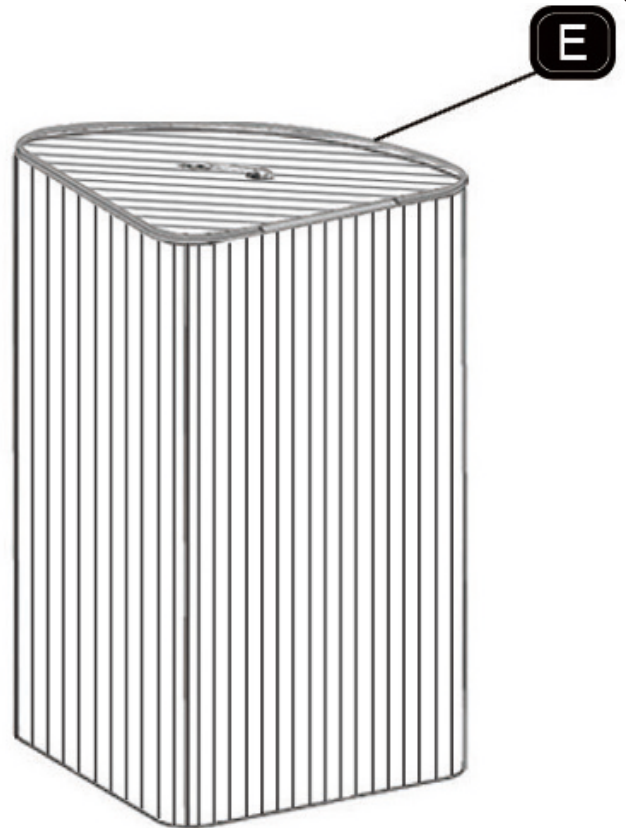

If you have any questions, please contact our customer care center, Our contact details are below:

US

 001-877-644-9366

 customerservice@aosom.com

Imported by Aosom LLC
27150 SW Kinsman Rd Wilsonville, OR 97070 USA
MADE IN CHINA

Wenn Sie Fragen haben, wenden Sie sich bitte an unser Kundendienstzentrum, Unsere Kontaktdaten stehen unten:

DE

 0049-0(40)-88307530

 service@aosom.de

ADRESSE DES IMPORTEURE/Hersteller/REP:
MH Handel GmbH
Wendenstraße 309
D-20537 Hamburg
Germany
IN CHINA HERGESTELLT

If you have any questions, please contact our customer care center, Our contact details are below:

CA

 416-792-6088

 customerservice@aosom.ca

Imported by Aosom Canada Inc.
7270 Woodbine Avenue, Unit 307, Markham,
Ontario Canada L3R 4B9
MADE IN CHINA

Si vous avez la moindre question, veuillez contacter notre centre d'assistance à la clientèle, Nos coordonnées sont les suivantes:

 416-792-6088

 customerservice@aosom.ca

Importé par Aosom Canada Inc.
7270 Woodbine Avenue, unité 307,
Markham, Ontario Canada L3R 4B9
FABRIQUÉ EN CHINE

In caso di dubbio, si prega di contattare il nostro centro assistenza clienti, I nostri dettagli di contatto sono di seguito:

IT

 0039-0249471447

 clienti@aosom.it

IMPORTATO DA/Produttore/REP:
AOSOM Italy srl
Centro Direzionale Milanofiori
Strada 1 Palazzo F1
20057 Assago (MI)
P.I.: 08567220960
FATTO IN CINA

Si tiene alguna pregunta, comuníquese con nuestro Centro de Atención al Cliente, Nuestros datos de contacto son los siguientes:

ES

 0034-931294512

 atencioncliente@aosom.es

IMPORTADOR/Fabricante/REP:
SPANISH AOSOM, S.L.
C/ROC GROS, N°15.08550, ELS HOSTALETS DE
BALENYÀ, SPAIN.
B66295775
HECHO EN CHINA

If you have any questions, please contact our customer care center, Our contact details are below:

UK

 0044-800-240-4004

 enquiries@mhstar.co.uk

IMPORTER ADDRESS:
MH STAR UK LTD
Unit 27, Perivale Park,
Horsenden lane South
Perivale, UB6 7RH
MADE IN CHINA

Se tiver alguma dúvida, por favor contacte o nosso Centro de Atendimento ao Cliente, Os nossos dados de contacto são os seguintes:

PT

 0034-931294512

 info@aosom.pt.

IMPORTADOR/Fabricante/REP:
SPANISH AOSOM, S.L.
C.ROC GROS N.15, 08550. ELS HOSTALETS DE
BALENYÀ
FEITO NA CHINA

Si vous avez la moindre question, veuillez contacter notre centre d'assistance à la clientèle, Nos coordonnées sont les suivantes:

FR

 0033-1-84166106

 aosom@mhfrance.fr

Importé par/Fabricant/REP:
MH FRANCE
2 Rue Maurice Hartmann
92130 Issy Les Moulineaux
France
FABRIQUÉ EN CHINE



FR

**DONNEZ
OU
RECYCLEZ**



ASSOCIATION

OU



LIVRAISON

OU



DÉCHÈTERIE

Adresses sur quefairedemesdechets.fr