

21
STEPS

2 HR



EN_IMPORTANT, RETAIN FOR FUTURE REFERENCE: READ CAREFULLY.

FR_IMPORTANT: A LIRE ATTENTIVEMENT ET À CONSERVER POUR CONSULTATION ULTÉRIEURE.

ES_IMPORTANTE, LEA Y GUARDE PARA FUTURAS REFERENCIAS.

PT_IMPORTANTE, RETER PARA REFERÊNCIA FUTURA: LEIA ATENTAMENTE.

DE_WICHTIG! SORFGFÄLTIG LESEN UND FÜR SPÄTERES NACHSCHLAGEN AUFBEWAHREN.

IT_IMPORTANTE! CONSERVARE IL PRESENTE MANUALE PER FUTURO RIFERIMENTO E LEGGERLO ATTENTAMENTE.

IF HAVE THIS ACCESSORY

NOTE DIFFERENT MODELS

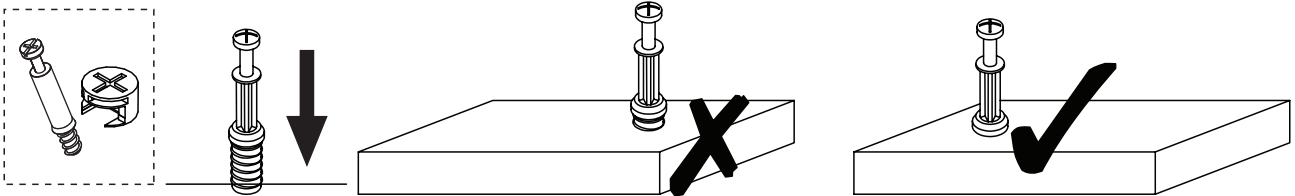

EN_QUICKFIT: Tighten quickfit until shoulder is flush with panel. Do not overtighten or undertighten.

FR_RACCORD RAPIDE: Faites serrer le raccord rapide jusqu'à ce que l'épaulement soit parfaitement encastré dans le panneau. Il ne faut ni trop serrer ni insuffisamment serrer.

ES_QUICKFIT: Apriete quickfit hasta que el hombro se descargue con el panel. NO lo sobreapriete ni lo apriete poco.

PT_AJUSTE RÁPIDO: Aperte o ajuste rápido até estar nivelada com o painel. Não apertar demasiado ou excessivamente.

DE_QUICKFIT: Ziehen Sie den Quickfit fest, bis die Schulter mit der Platte bündig ist. Bitte nicht zu fest oder zu schwach anziehen.

IT_MONTAGGIO RAPIDO: Stringere il montaggio rapido fino a quando la spalla è a filo con il pannello, non stringere troppo o troppo poco.

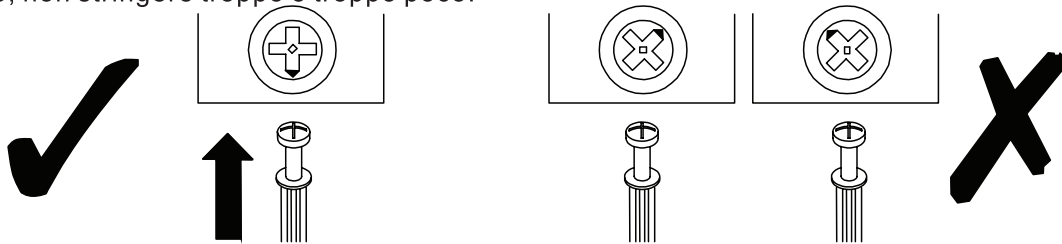

EN_CAM LOCK: When fitting cam lock, ensure starting position is correct before you insert connecting quickfit.

FR_SERRURE BATTEUSE: Avant d'insérer la serrure batteuse, veillez à la bonne orientation avant d'insérer le raccord rapide.

ES_CIERRE DE LA CÁMARA: Cuando instale el cierre de la cámara, asegúrese de que la posición de inicio es correcta antes de que inserte el quickfit conector.

PT_BLOQUEIO: Ao instalar o bloqueio, assegurar-se de que a posição inicial está correcta antes de inserir o encaixe de ligação rápida.

DE_CAM-LOCK: Achten Sie bei der Montage des Cam-Locks auf die richtige Ausgangsposition, bevor Sie den Quickfit einsetzen.

IT_BLOCCAGGIO A CAMMA: Quando si monta il bloccaggio a camma, assicurarsi che la posizione iniziale sia corretta prima di inserire il montaggio rapido di collegamento.

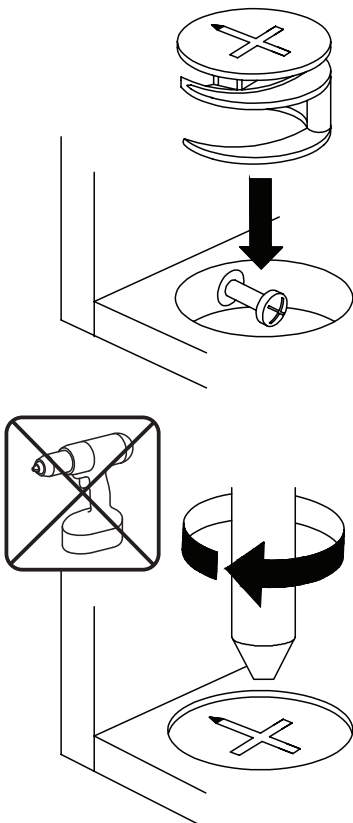

EN_Quickfit head should be in the centre of the cam lock when the two panels are joined.

Cam lock should be inserted before quickfit.

FR_Lorsque les deux panneaux sont assemblés, la tête du raccord rapide doit reposer au centre de la serrure batteuse.

Il faut insérer la serrure batteuse avant le raccord rapide.

ES_El cabezal del quickfit debe estar en el centro del cierre de la cámara cuando se unan los dos paneles.

Se debe insertar el cierre de la cámara antes que el quickfit.

PT_A cabeça de ajuste rápido deve estar no centro da fechadura quando os dois painéis estão unidos.

A fechadura de cames deve ser inserida antes de ser rápida.

DE_Der Quickfit-Kopf sollte sich in der Mitte des Cam-Locks befinden, wenn die beiden Platten zusammengefügt sind.

Der Cam-Lock sollte vor dem Quickfit eingesetzt werden.

IT_La testa del montaggio rapido deve trovarsi al centro del bloccaggio a camma quando i due pannelli sono uniti.

Il Bloccaggio a Camma deve essere inserito prima del montaggio rapido.

EN_Turn cam lock clockwise to tighten.

FR_Faites tourner la serrure batteuse dans le sens des aiguilles d'une montre pour la resserrer.

ES_Gire el cierre de la cámara en sentido horario para apretarlo.

PT_Rodar o bloqueio no sentido dos ponteiros do relógio para o apertar.

DE_Drehen Sie den Cam-Lock im Uhrzeigersinn, um ihn festzuziehen.

IT_Ruotare il bloccaggio a camma in senso orario per stringere.

IF HAVE THIS ACCESSORY

NOTE DIFFERENT MODELS

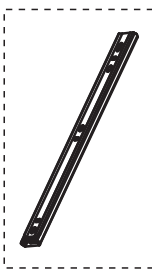

EN_NOTE: Pull inner and outer drawer runners apart before fixing them to panels.

FR_REMARQUE: Avant de fixer les glissières de tiroir aux panneaux, tirez vers l'extérieur et poussez vers l'intérieur de chacun des tiroirs.

ES_NOTA: retire los rieles interiores y exteriores antes de fijarlos a los paneles.

PT_NOTA: Separar as corrediças das gavetas interiores e exteriores antes de fixar para os painéis.

DE_HINWEIS: Ziehen Sie die inneren und äußeren Schubladenführung auseinander, bevor Sie sie an den Platten befestigen.

IT_NOTA: Separare le guide interne ed esterne del cassetto prima di fissarle ai pannelli.

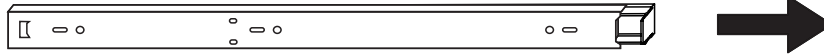

EN Slide drawer runners apart until the drawer lock can be seen, as shown.

FR Les glissières de tiroir doivent être ouvertes jusqu'à ce que la serrure du tiroir soit visible, comme indiqué.

ES Deslice a un lado los rieles del cajón hasta que se pueda ver el cierre del armario, tal y como se muestra.

PT Deslizam-se as gavetas até se poder ver o fecho da gaveta, como se mostra.

DE Schieben Sie die Schubladenführungen auseinander, bis das Schubladenschloss sichtbar ist, gemäß der Abbildung.

IT Far scorrere le guide del cassetto fino a quando non sia visibile il blocco di scorrimento, come mostrato.

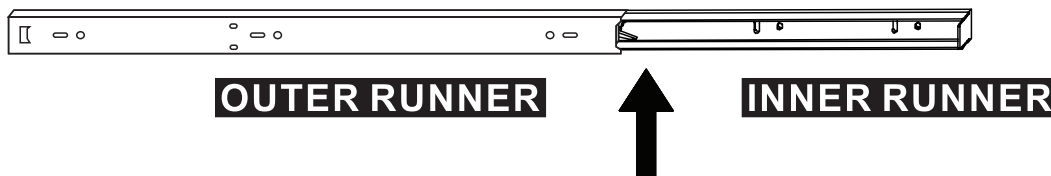

EN Press and hold the drawer runner lock and then continue to slide drawer runners apart, as shown.

FR En appuyant et en maintenant le verrouillage des glissières de tiroir, vous pouvez continuer à les écarter l'une de l'autre, comme indiqué.

ES Mantenga presionado el cierre del riel del cajón y después continúe deslizando a un lado los rieles de los cajones, tal y como se muestra.

PT Manter pressionado o fecho de gaveta e depois continuar a deslizar as corrediças da gaveta, como mostrado.

DE Drücken und halten Sie die Verriegelung der Schubladenführung und schieben Sie die Schubladenführungen wie abgebildet weiter auseinander.

IT Tenere premuto il blocco di scorrimento e quindi continuare a far scorrere la guida, come mostrato.

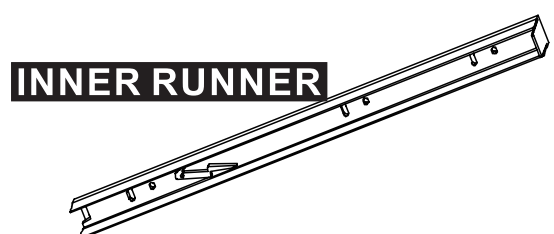
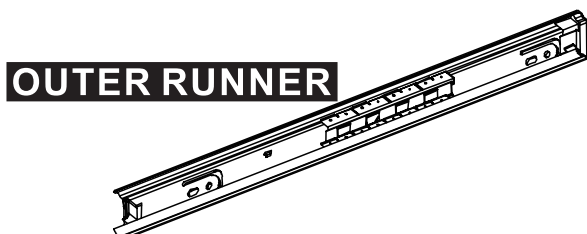
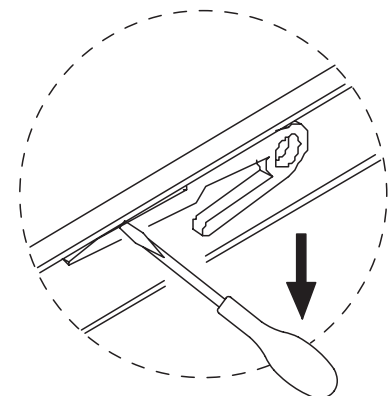

EN Your inner and outer drawer runners are ready to be fixed to panels.

FR Il est possible, à présent, de fixer les glissières intérieures et extérieures de vos tiroirs sur des panneaux.

ES Los rieles interiores y exteriores del cajón están listos para fijarse a los paneles.







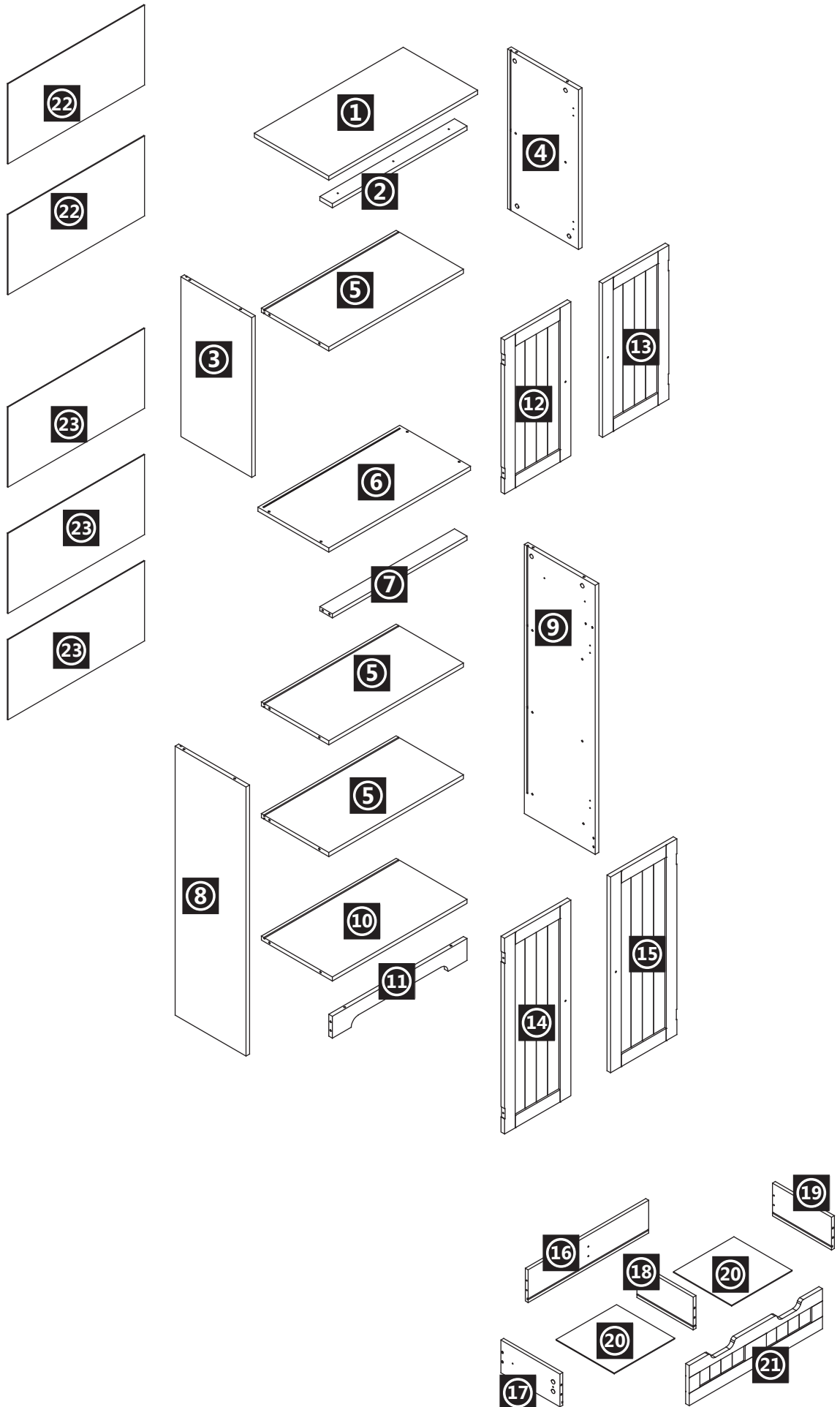

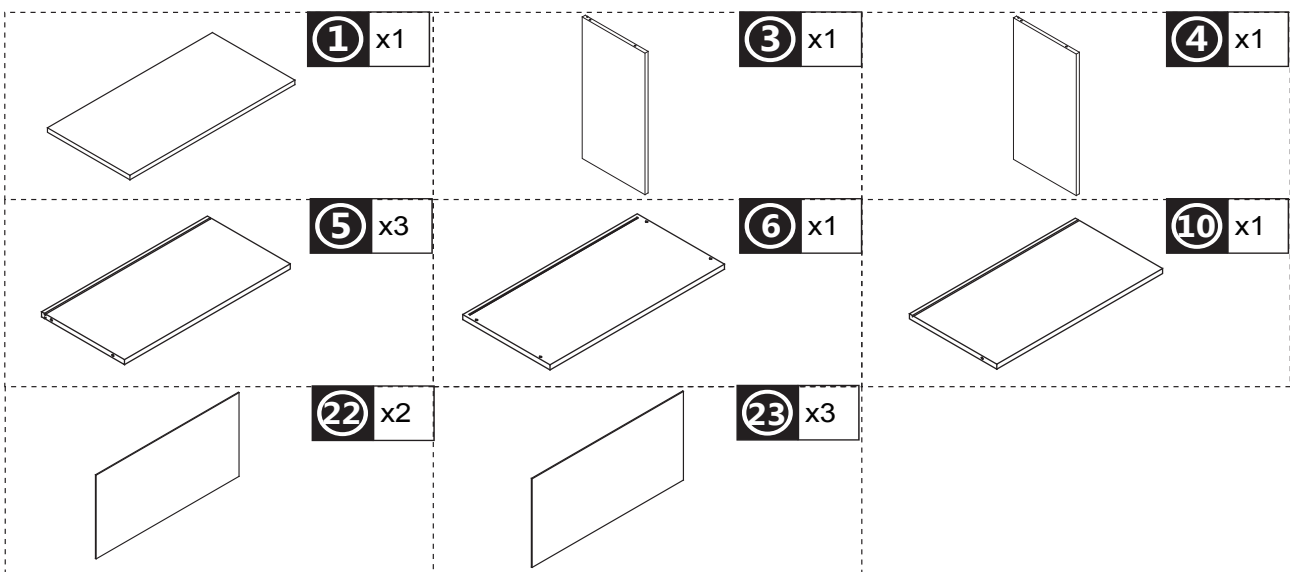
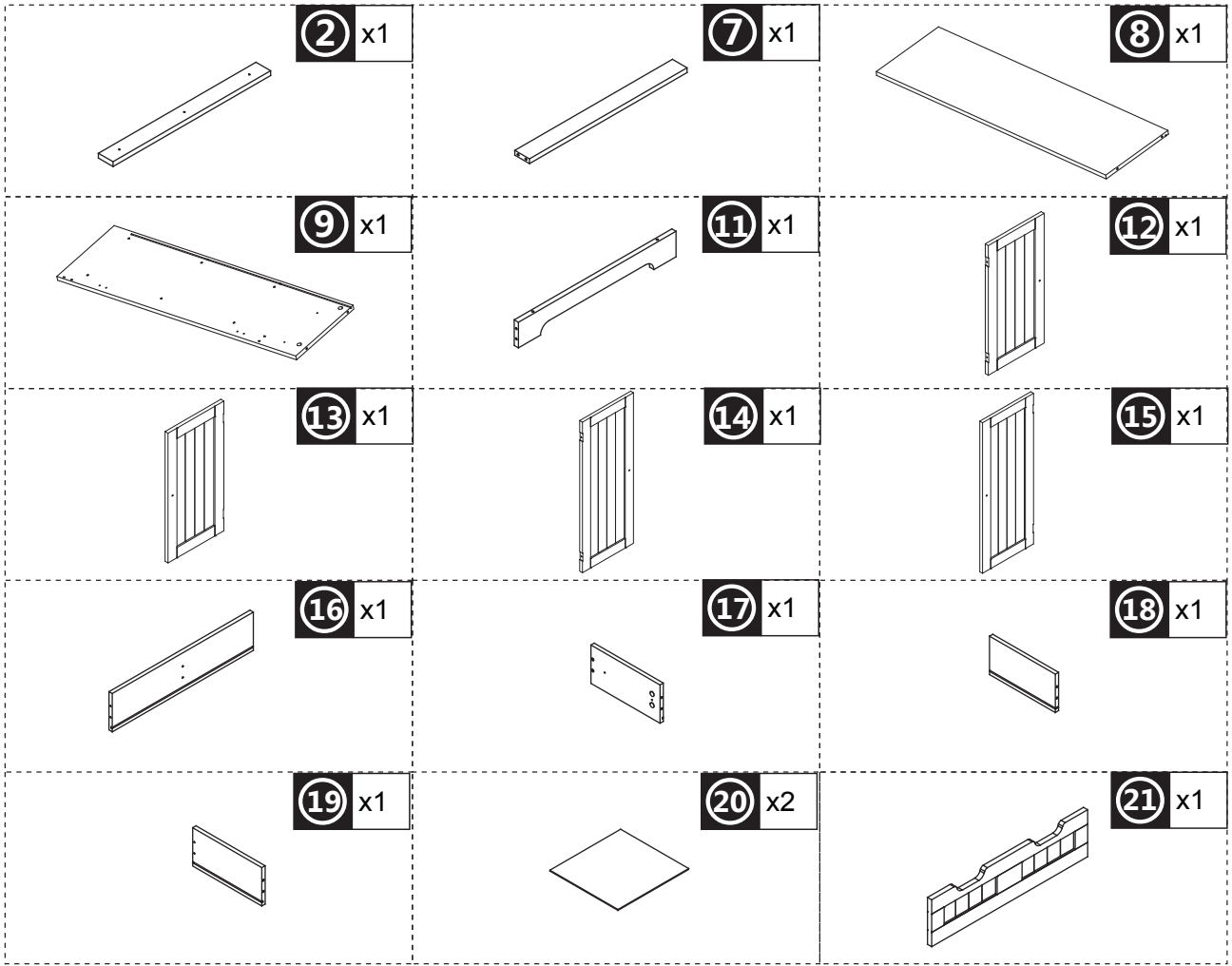



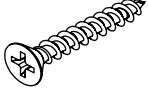

PT As corrediças das gavetas interiores e exteriores estão prontas para serem fixadas nos painéis.

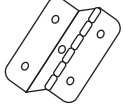
DE Ihre inneren und äußeren Schubladenführungen sind bereit, an den Platten befestigt zu werden.

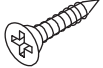
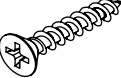
IT Le guide interne ed esterne sono pronte per essere fissate ai pannelli.



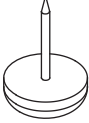

	<p>A x26 M15*12 +1(spare)</p>		<p>B x44 M6*40 +1(spare)</p>		<p>C x56 M3*12 +1(spare)</p>
	<p>D x06 M4*30 +1(spare)</p>		<p>E x04</p>		<p>F x04</p>
	<p>G x04</p>		<p>H x04</p>		<p>I x08</p>
 	<p>J x20</p>		<p>K x03 M4*25 +1(spare)</p>		<p>L x01</p>
	<p>M x02</p>		<p>N x02</p>		<p>O x08 M4*12 +1(spare)</p>
	<p>P x18 M15*9 +1(spare)</p>		<p>Q x06</p>		

B x 4

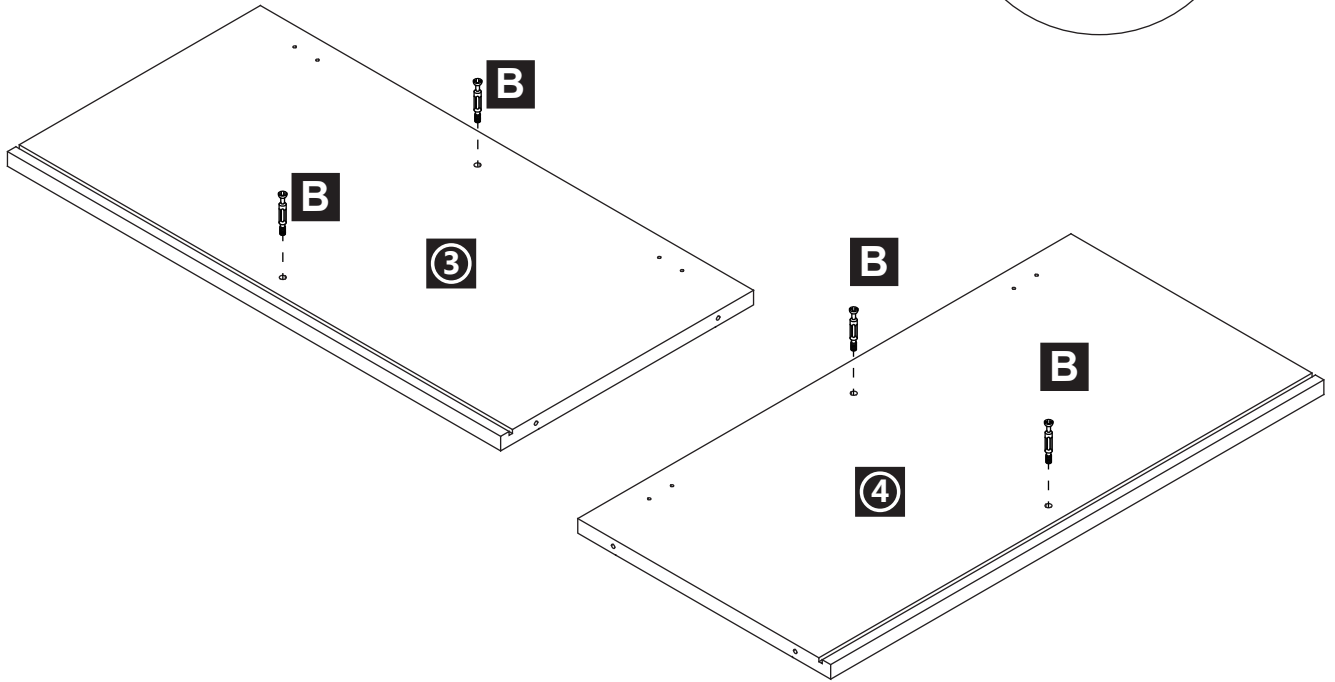
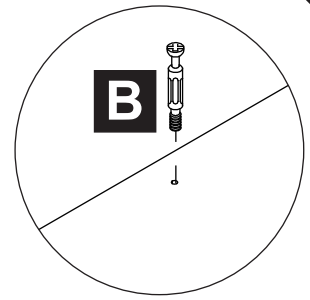

P x 4

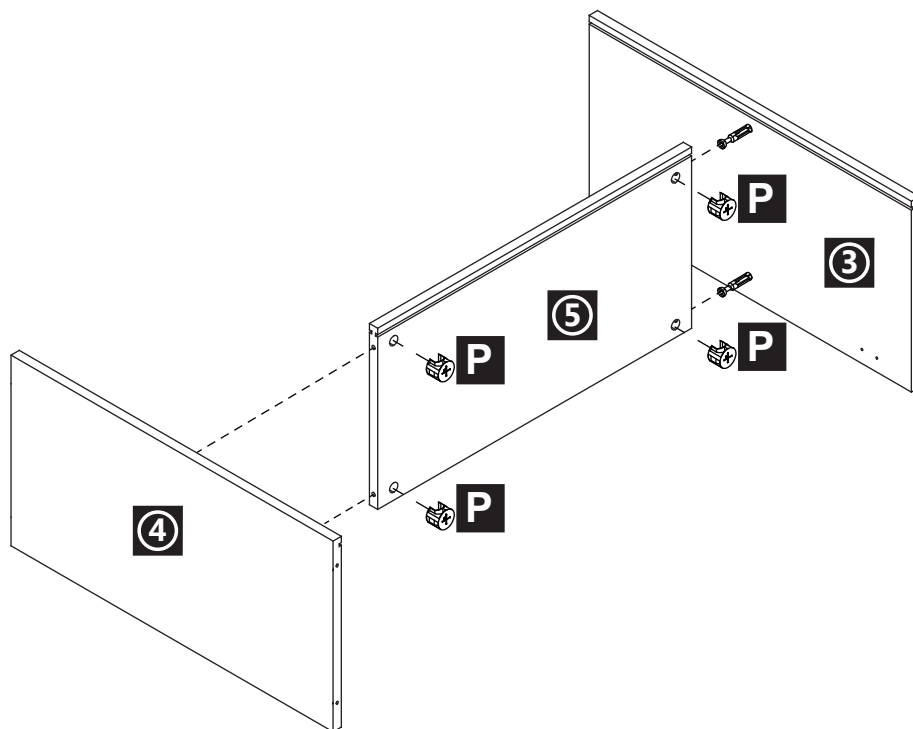

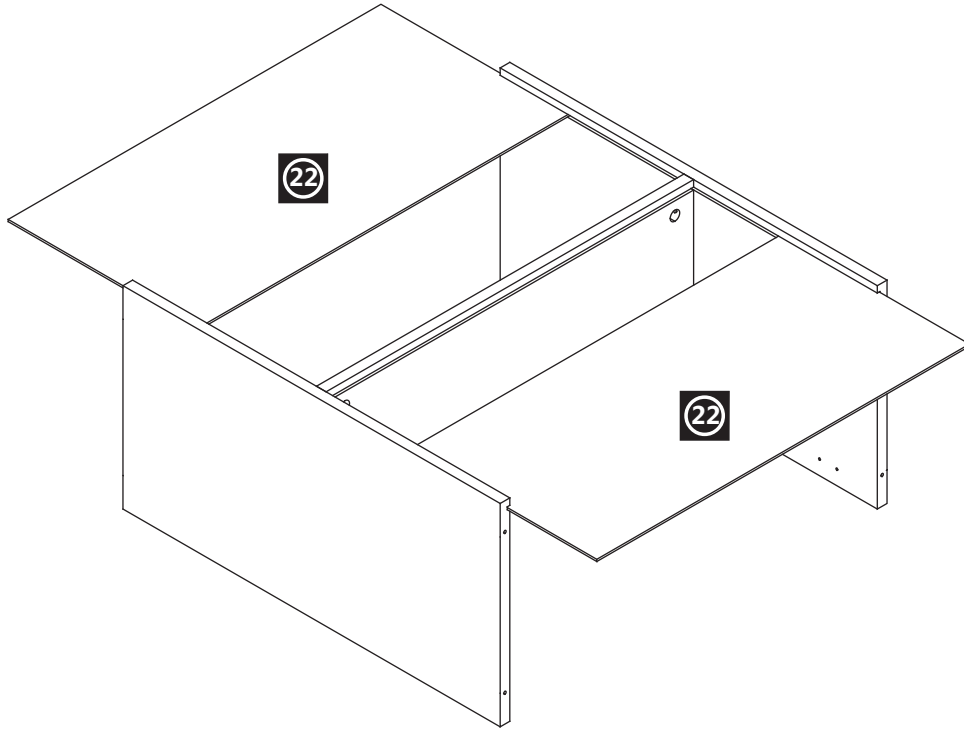

- B** x 4
- C** x 4
- G** x 2
- K** x 3

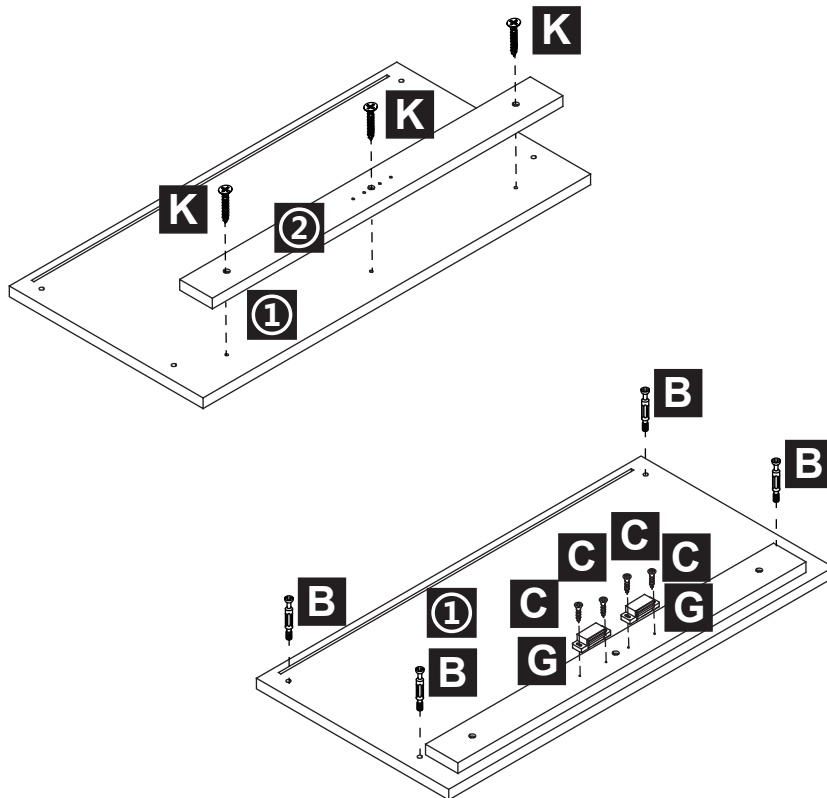

B x 8

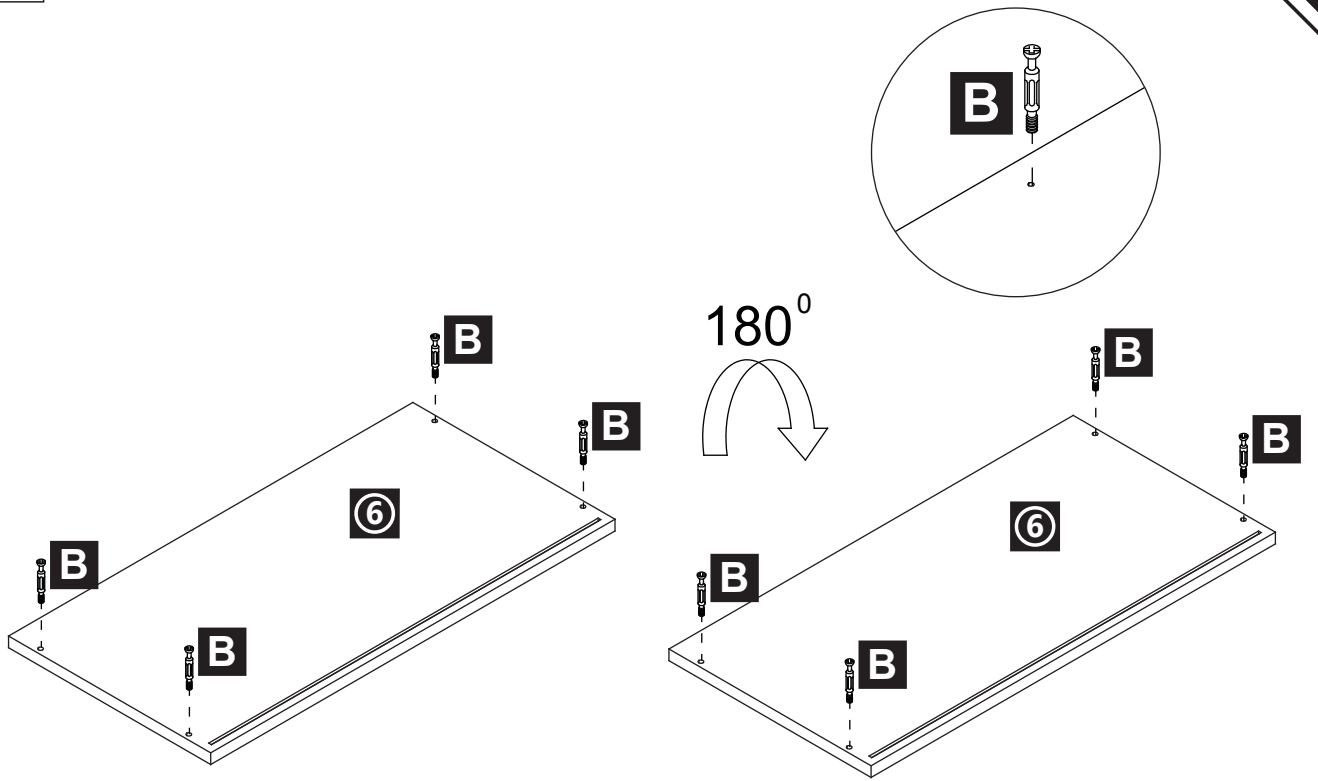

A x 8

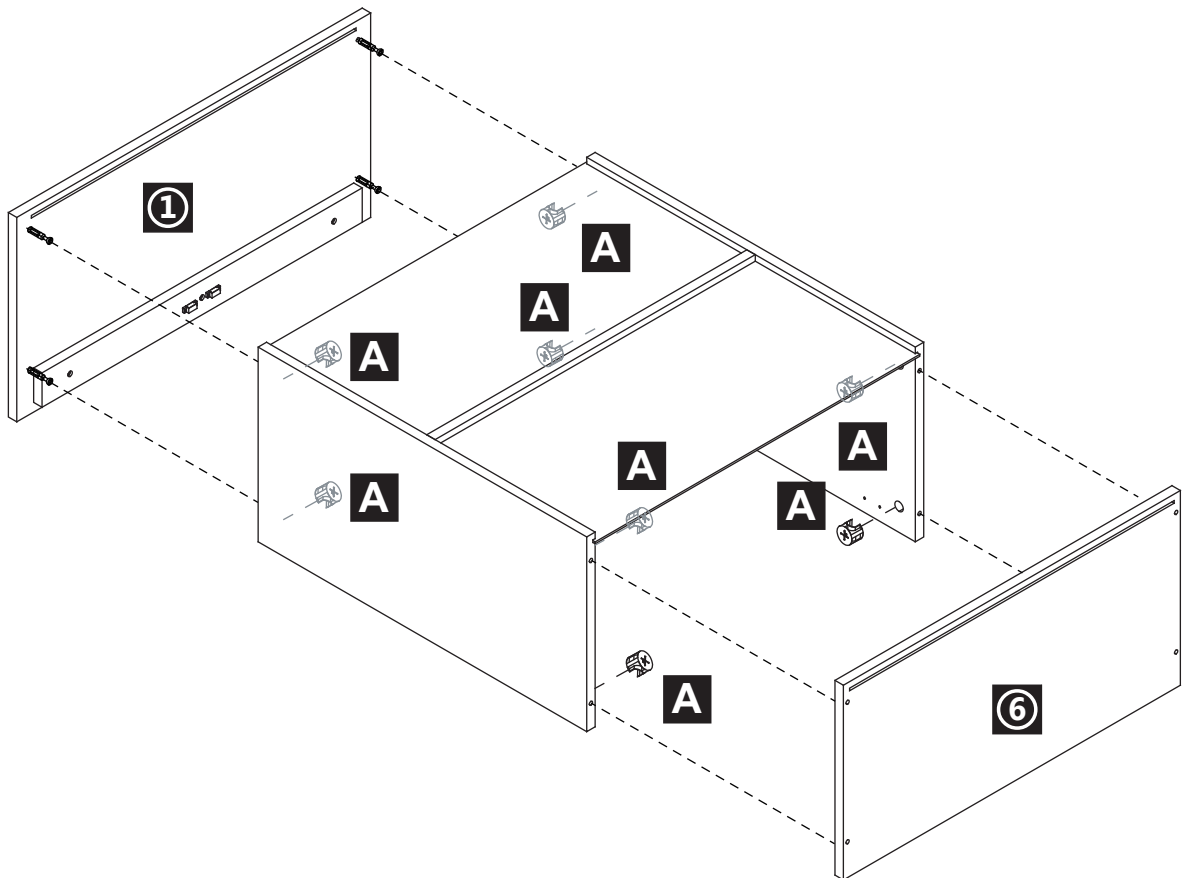

B x20

M x 2

O x 4

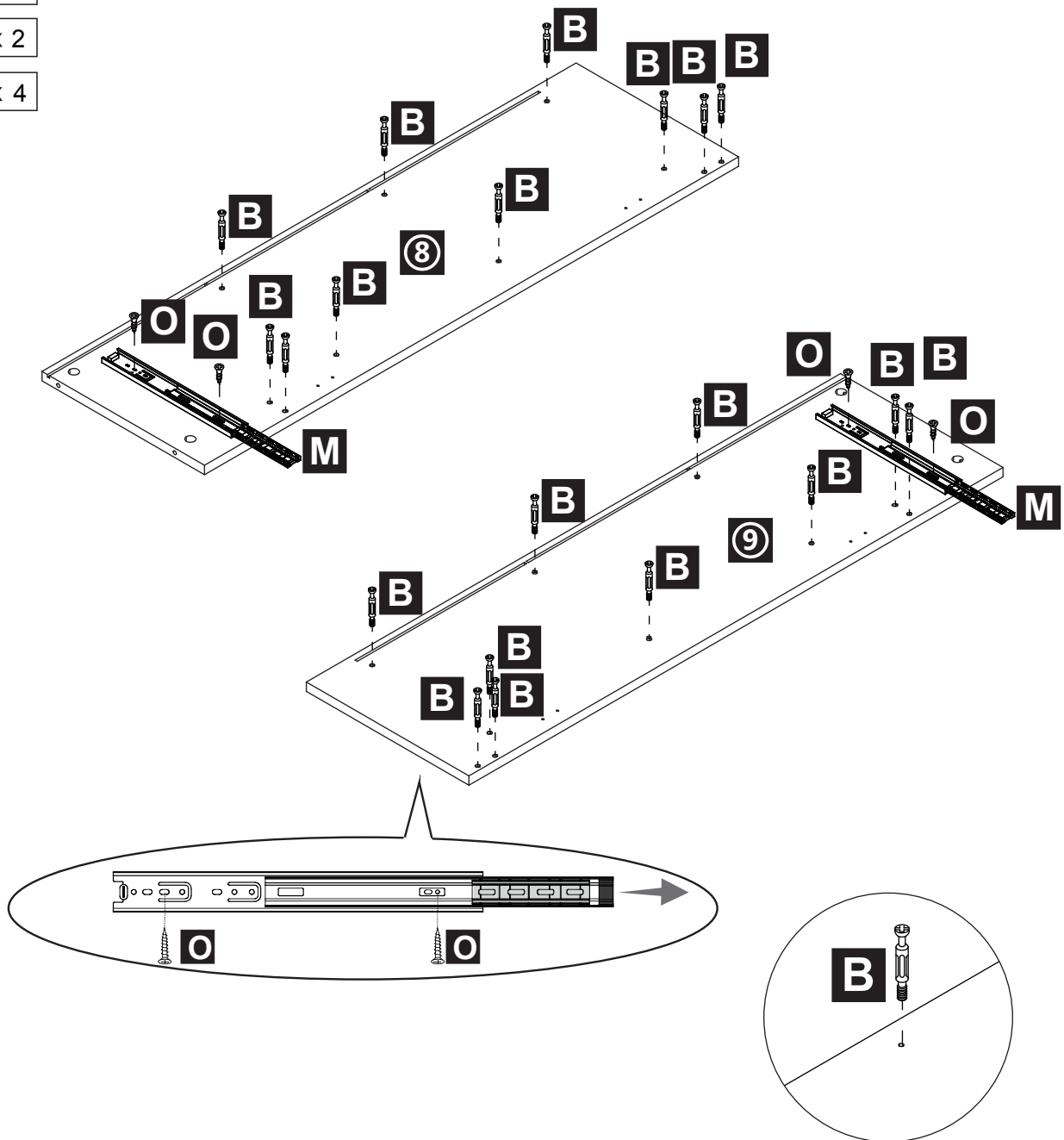

EN_ Please find the exact hole for installation, otherwise it will be misaligned. The screws on the drawer slide must be leveled, otherwise it will affect the smoothness of the drawer.

FR_ Identifiez le trou exact pour l'installation, sinon il sera mal aligné. Les vis de la glissière du tiroir doivent être nivelées, sinon cela affectera le fonctionnement du tiroir.

ES_ Al instalar, encuentre el orificio exacto; de lo contrario, estará desalineado. Los tornillos en las correderas del cajón deben estar nivelados, de lo contrario, afectará la suavidad al deslizar el cajón.

PT_ Por favor encontre o orifício exato para instalação, caso contrário será desalinhado. Os parafusos na corredeira da gaveta devem ser nivelados, caso contrário afetará a suavidade da abertura da gaveta.

DE_ Bitte finden Sie das genaue Loch für die Installation, sonst wird es falsch ausgerichtet werden. Die Schrauben an der Schubladenführung müssen nivelliert werden, da sonst die Leichtgängigkeit der Schublade beeinträchtigt wird.

IT_ individuare il foro esatto per l'installazione, altrimenti ci sarà un disallineamento. Le viti sulla guida del cassetto devono essere allineate, altrimenti influirà sulla scorrevolezza del cassetto.

A x 2

B x 2

C x 4

G x 2

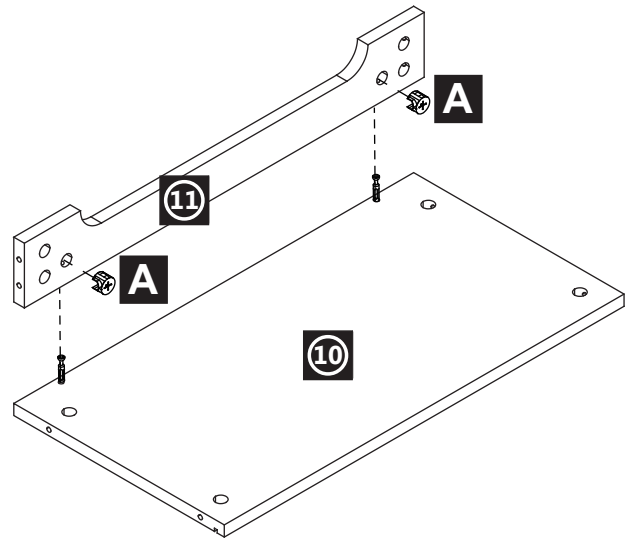
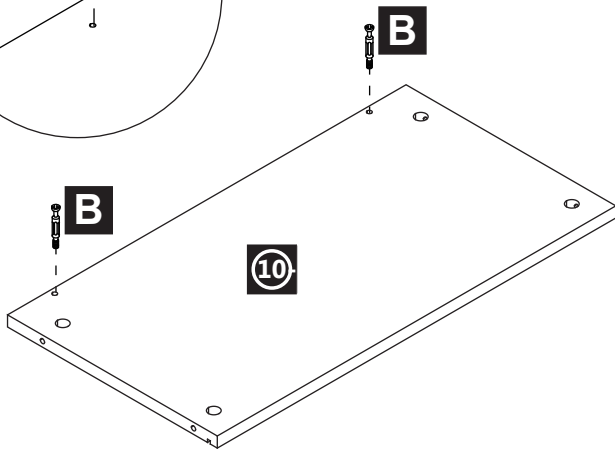
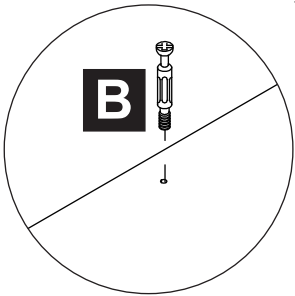
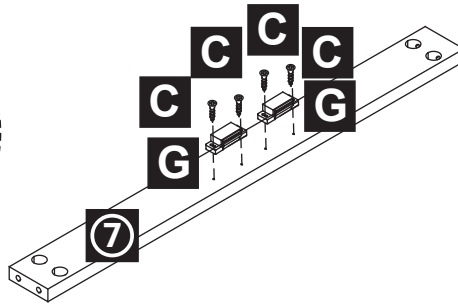
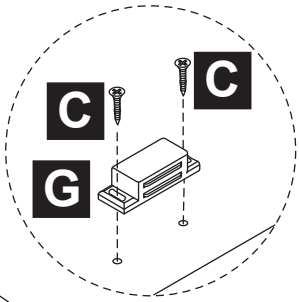

A x 06

P x 04

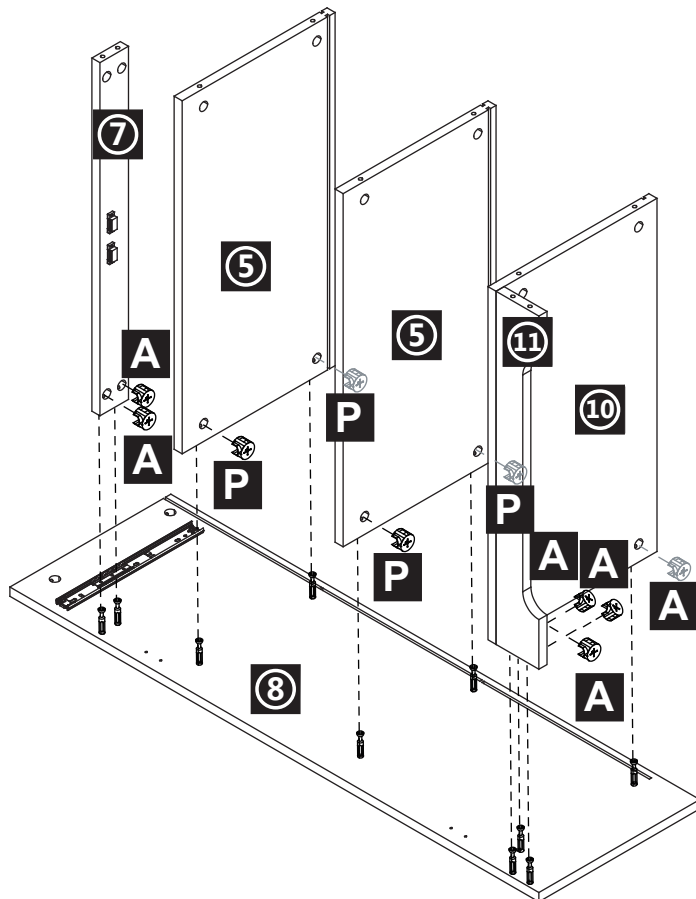

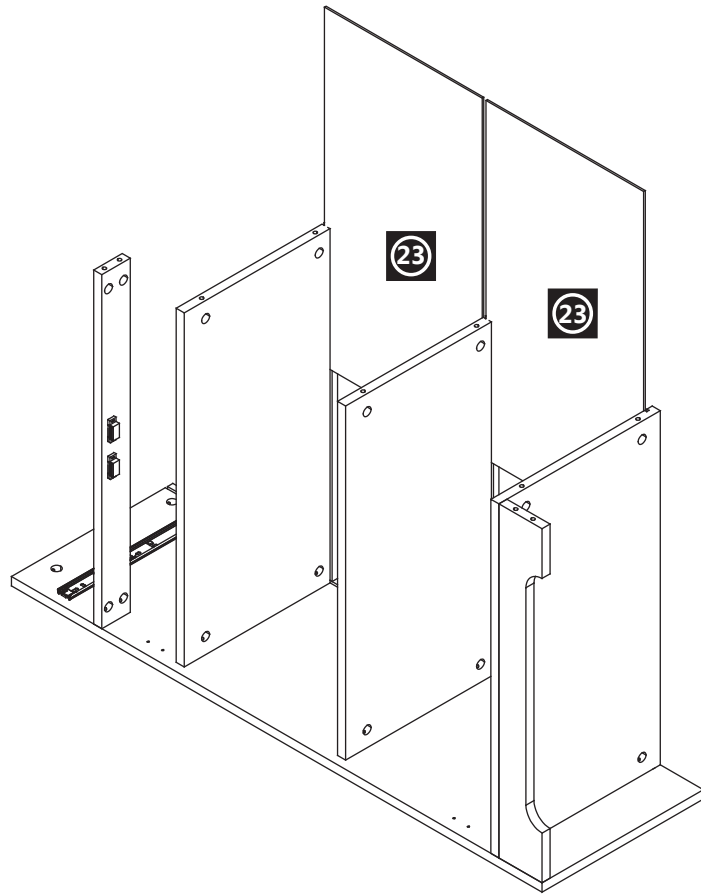

A x06

P x04

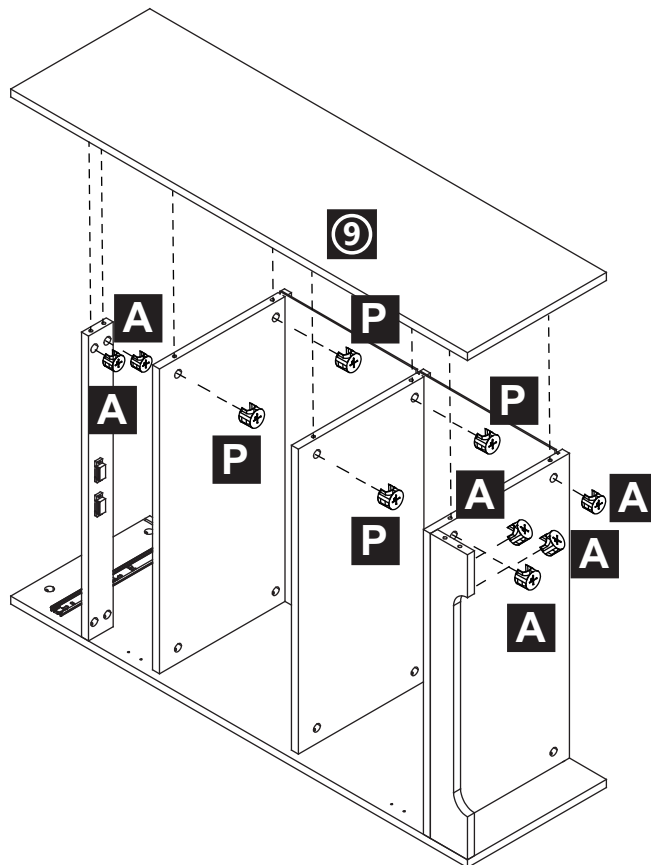

Q x 6

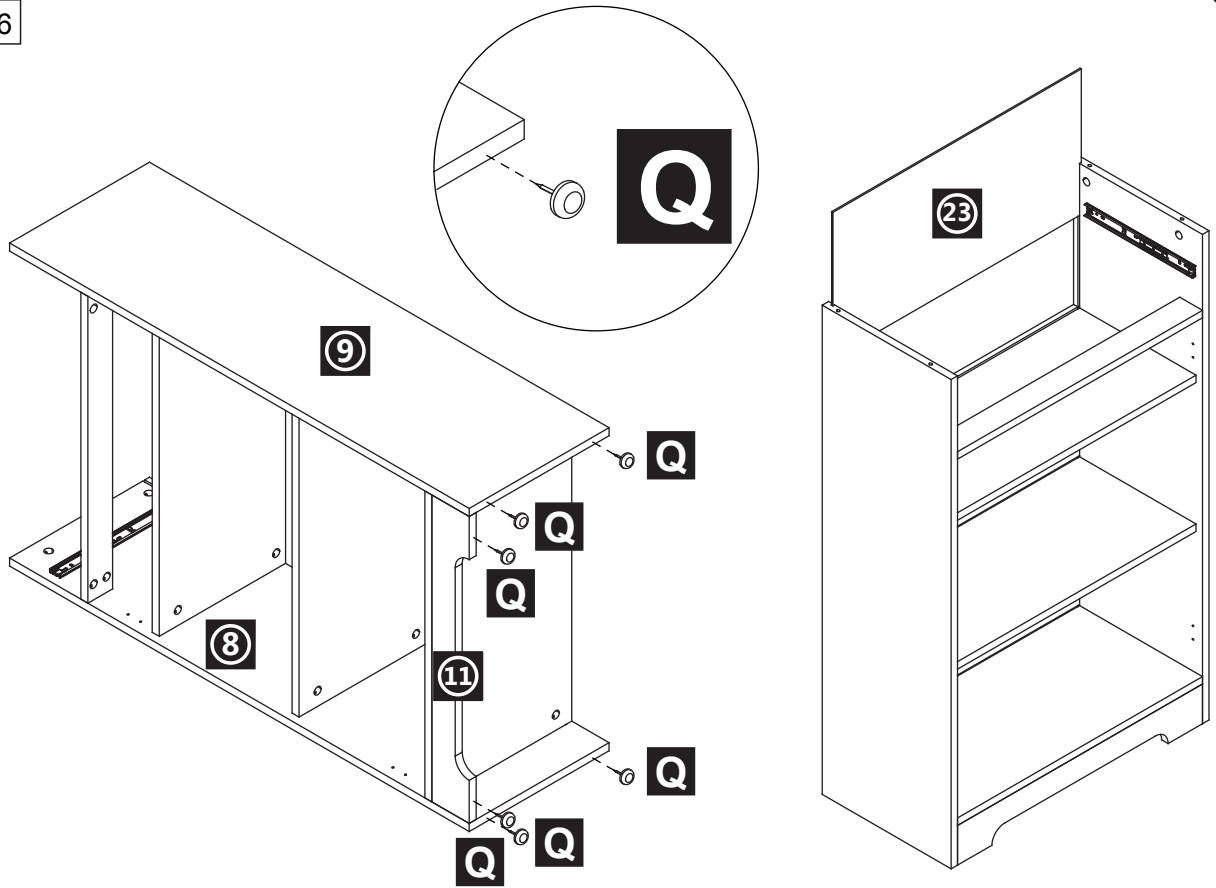

A x 4

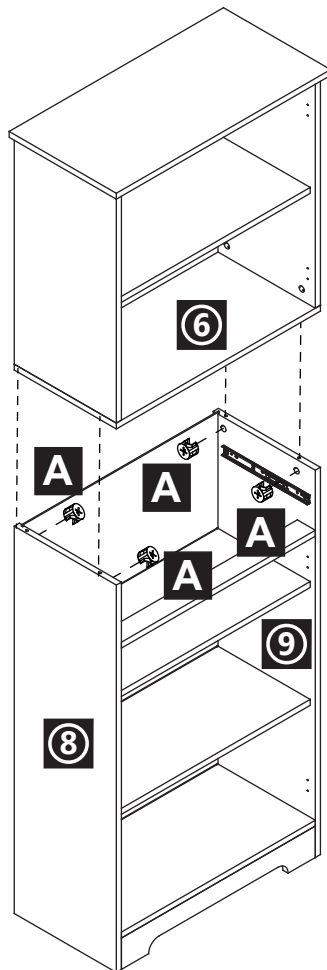

- C** x16
- E** x 2
- F** x 2
- H** x 2
- I** x 4

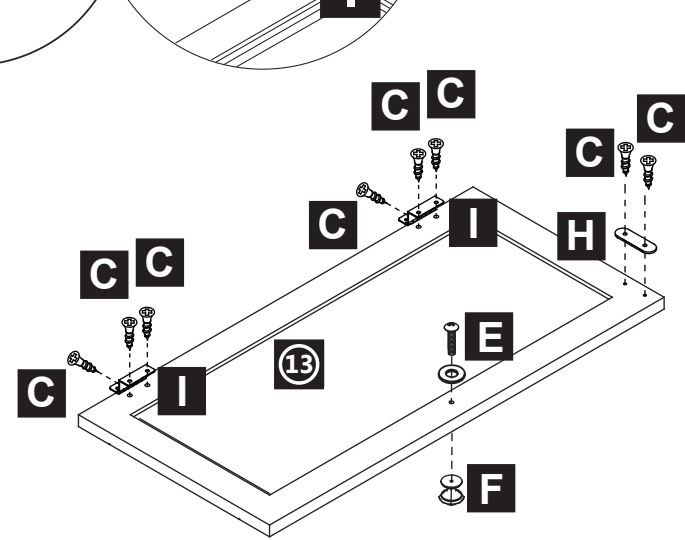
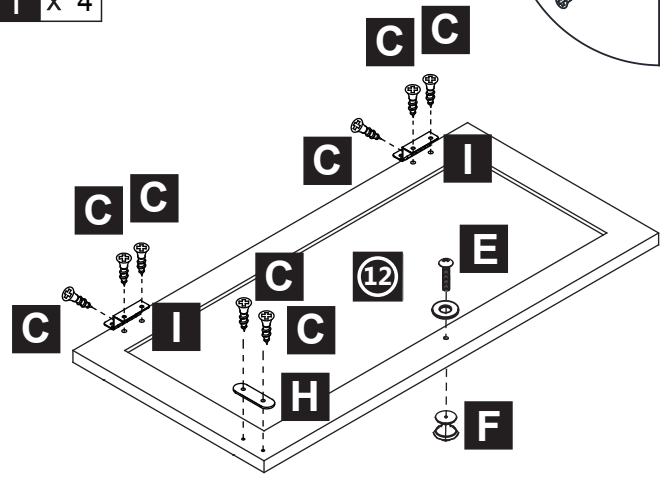
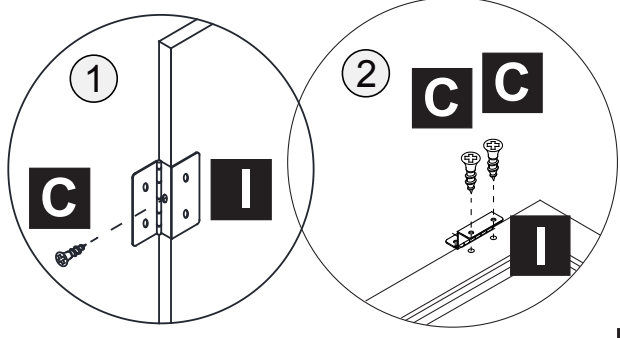

- C** x16
- E** x 2
- F** x 2
- H** x 2
- I** x 4

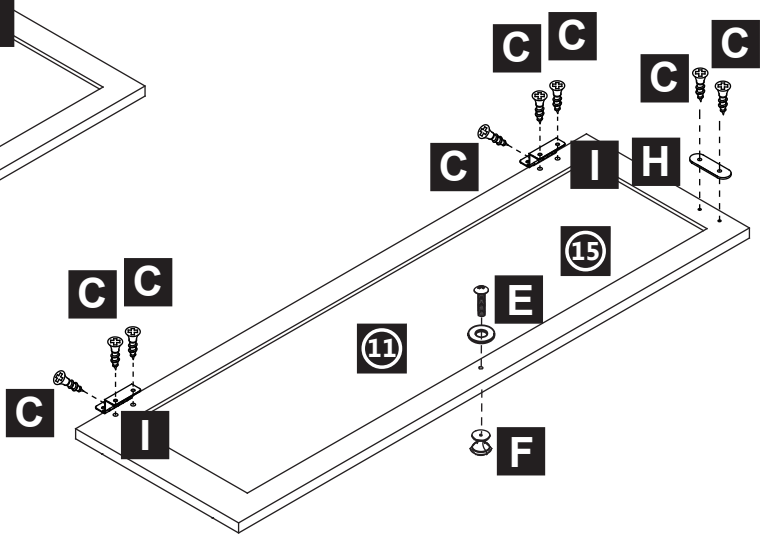
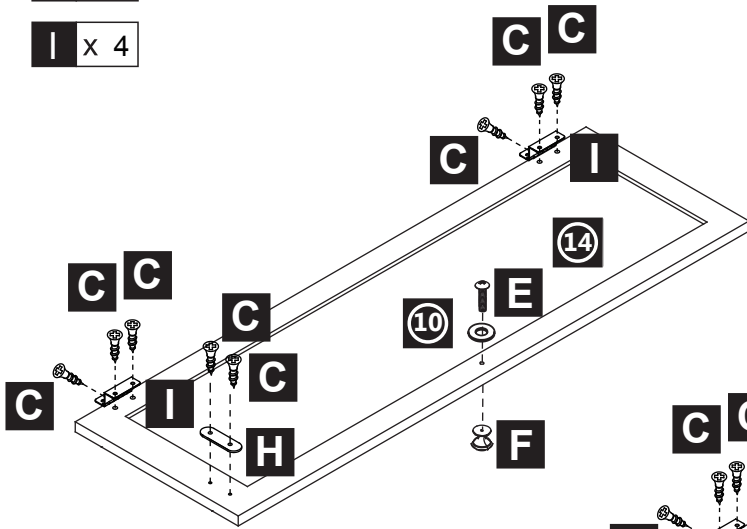
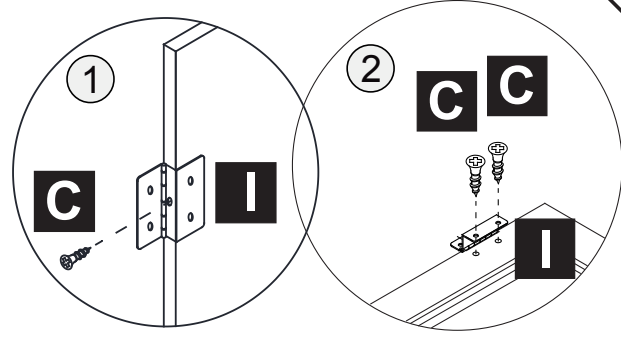

C x16

16

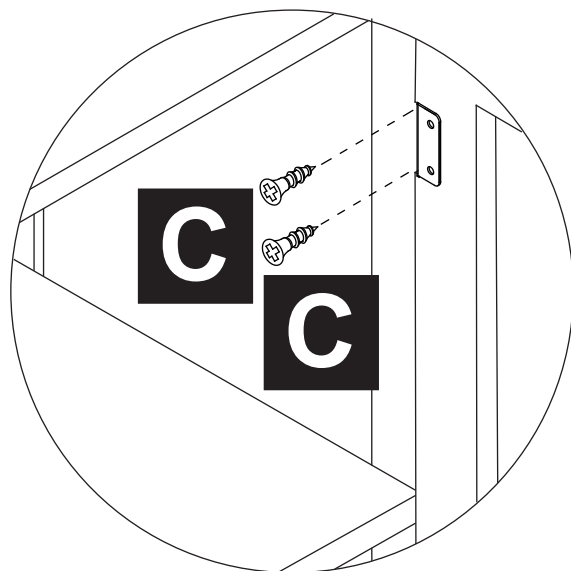
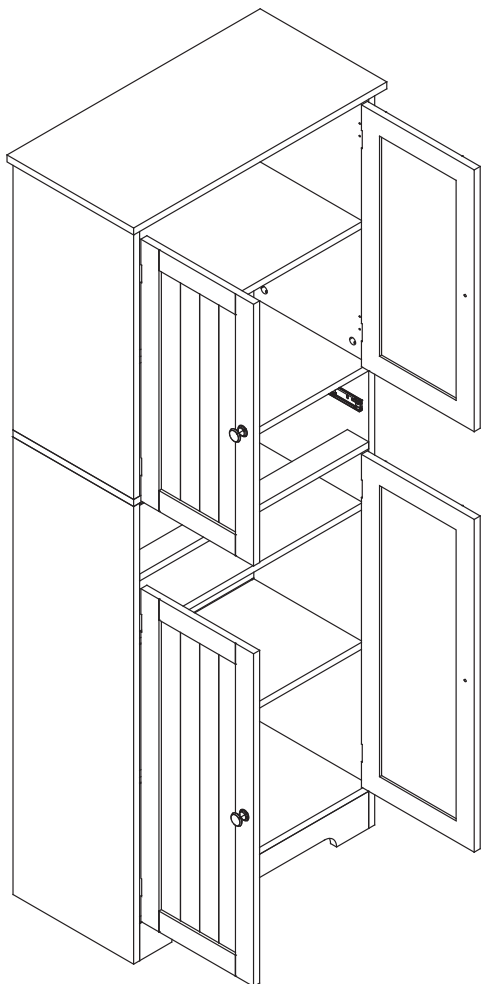

J x20

17

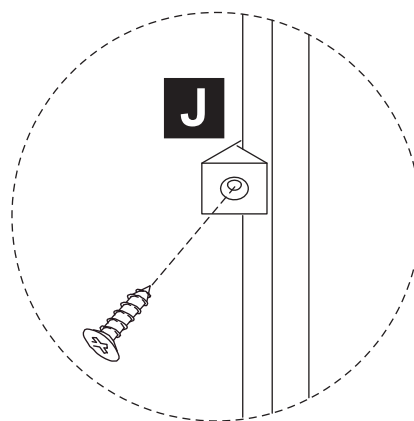
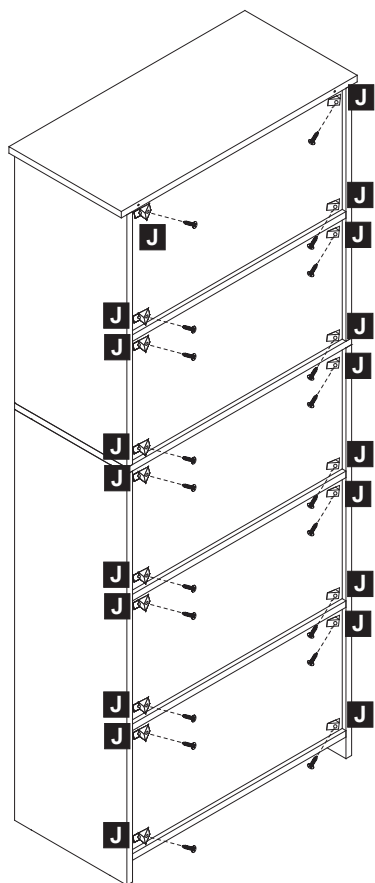

B x 6

D x 6

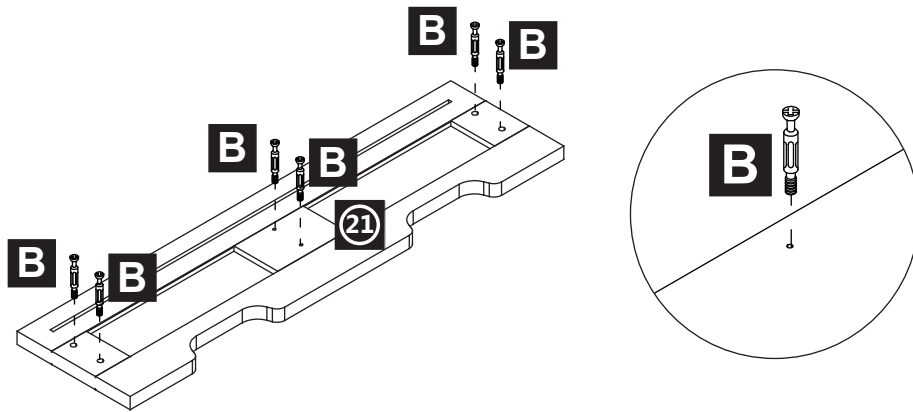
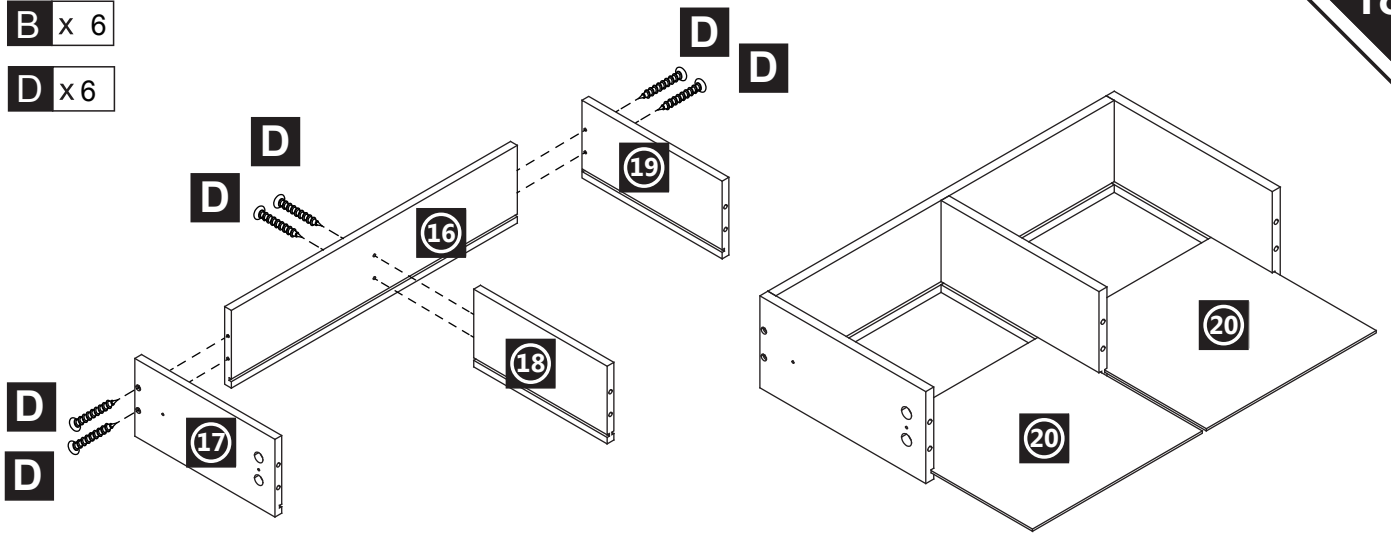

N x 2

O x 4

P x 6

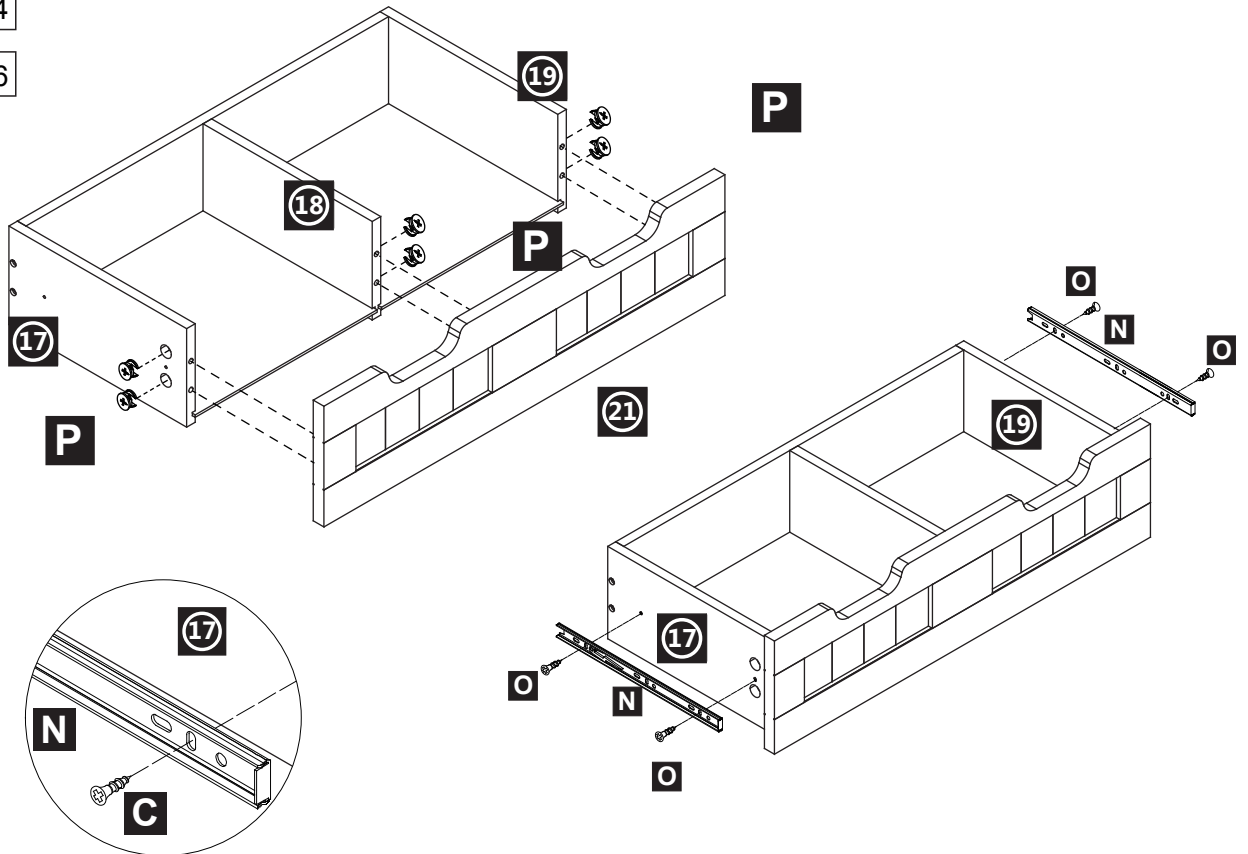

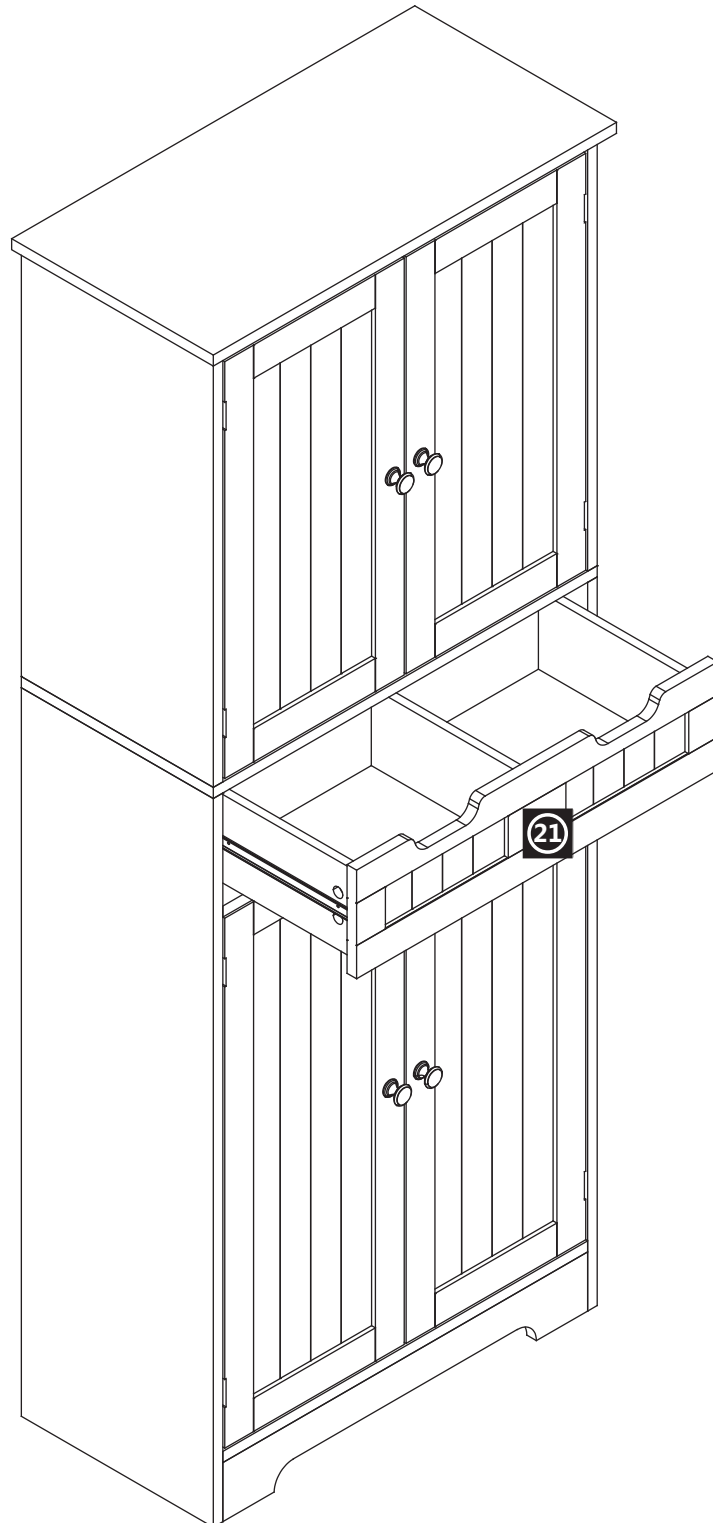

EN Be careful to push in the board when the both sides slide way been aligned.

FR Prenez soin d'enfoncer la planche lorsque les deux côtés de la glissière sont alignés.

ES Empuje con cuidado el tablero después de que los dos lados se hayan alineado.

PT Ter o cuidado de empurrar a placa quando os dois lados estiverem alinhados.

DE Achten Sie darauf, dass Sie die Platte einschieben, wenn die beiden Seiten so ausgerichtet sind, dass sie gleiten.

IT Fare attenzione quando si spinge il cassetto quando le due guide di scorrimento sono state allineati.

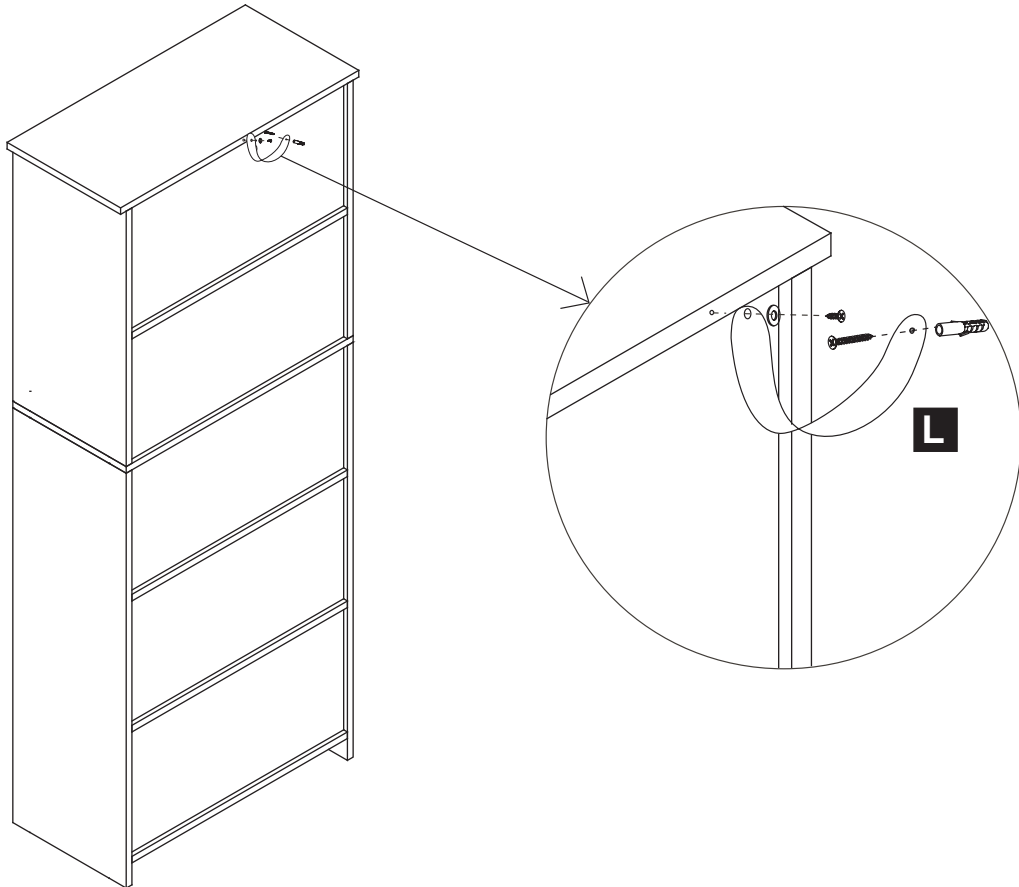

IF HAVE THIS ACCESSORY

NOTE DIFFERENT MODELS

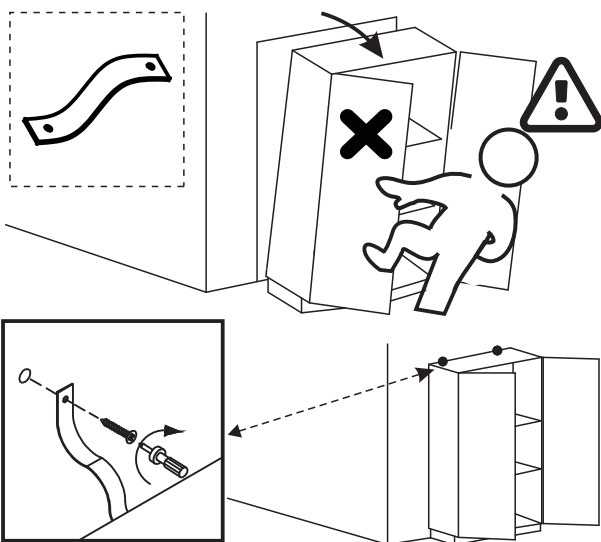

EN_ This is anti-dumping belt that fix the product to the wall and it can be used or not follow your needs.

FR_ Cette sangle anti-basculement permet de fixer le produit au mur. Elle peut être utilisée ou non selon vos besoins.

ES_ Esta es una correa anti-vuelco para fijar el producto a la pared, y según sus necesidades, puede utilizarla o no.

PT_ Este é o sistema anti-tombo que fixa o produto à parede e pode ser usado para uma maior segurança.

DE_ Dies ist Anti-Sturz-Gurt, um das Gerät an der Wand zu befestigen und es kann je nach Bedarf verwendet oder nicht verwendet werden.

IT_ Questa è una cintura anticaduta che fissa il prodotto alla parete e può essere utilizzata o meno a seconda delle vostre esigenze.

If you have any questions, please contact our customer care center, Our contact details are below:

US

 001-877-644-9366

 customerservice@aosom.com

Imported by Aosom LLC
27150 SW Kinsman Rd Wilsonville, OR 97070 USA
MADE IN CHINA

Wenn Sie Fragen haben, wenden Sie sich bitte an unser Kundendienstzentrum, Unsere Kontaktdaten stehen unten:

DE

 0049-0(40)-88307530

 service@aosom.de

ADRESSE DES IMPORTEURE/Hersteller/REP:
MH Handel GmbH
Wendenstraße 309
D-20537 Hamburg
Germany
IN CHINA HERGESTELLT

If you have any questions, please contact our customer care center, Our contact details are below:

CA

 416-792-6088

 customerservice@aosom.ca

Imported by Aosom Canada Inc.
7270 Woodbine Avenue, Unit 307, Markham,
Ontario Canada L3R 4B9
MADE IN CHINA

Si vous avez la moindre question, veuillez contacter notre centre d'assistance à la clientèle, Nos coordonnées sont les suivantes:

 416-792-6088

 customerservice@aosom.ca

Importé par Aosom Canada Inc.
7270 Woodbine Avenue, unité 307,
Markham, Ontario Canada L3R 4B9
FABRIQUÉ EN CHINE

In caso di dubbio, si prega di contattare il nostro centro assistenza clienti, I nostri dettagli di contatto sono di seguito:

IT

 0039-0249471447

 clienti@aosom.it

IMPORTATO DA/Produttore/REP:
AOSOM Italy srl
Centro Direzionale Milanofiori
Strada 1 Palazzo F1
20057 Assago (MI)
P.I.: 08567220960
FATTO IN CINA

Si tiene alguna pregunta, comuníquese con nuestro Centro de Atención al Cliente, Nuestros datos de contacto son los siguientes:

ES

 0034-931294512

 atencioncliente@aosom.es

IMPORTADOR/Fabricante/REP:
SPANISH AOSOM, S.L.
C/ROC GROS, N°15.08550, ELS HOSTALET DE
BALENYÀ, SPAIN.
B66295775
HECHO EN CHINA

If you have any questions, please contact our customer care center, Our contact details are below:

UK

 0044-800-240-4004

 enquiries@mhstar.co.uk

IMPORTER ADDRESS:
MH STAR UK LTD
Unit 27, Perivale Park,
Horsenden lane South
Perivale, UB6 7RH
MADE IN CHINA

Se tiver alguma dúvida, por favor contacte o nosso Centro de Atendimento ao Cliente, Os nossos dados de contacto são os seguintes:

PT

 0034-931294512

 info@aosom.pt

IMPORTADOR/Fabricante/REP:
SPANISH AOSOM, S.L.
C.ROC GROS N.15, 08550. ELS HOSTALET DE
BALENYÀ
FEITO NA CHINA

Si vous avez la moindre question, veuillez contacter notre centre d'assistance à la clientèle, Nos coordonnées sont les suivantes:

FR

 0033-1-84166106

 aosom@mhfrance.fr

Importé par/Fabricant/REP:
MH FRANCE
2 Rue Maurice Hartmann
92130 Issy Les Moulineaux
France
FABRIQUÉ EN CHINE



FR

DONNEZ
OU
RECYCLEZ



ASSOCIATION

OU



LIVRAISON

OU



DÉCHÈTERIE

Adresses sur quefairedemesdechets.fr