

- 01.SWITCH OFF MAIN
- 02.MAKE HOLE PATTERN
- 03.INSTALL THE BASE PLATE
- 04.CONNECT LAMP TO THE MAIN
- 05.DRIVE IN THE SCREWS UNTILL TIGHT
- 06.SWITCH ON THE MAIN AND LIGHT ON

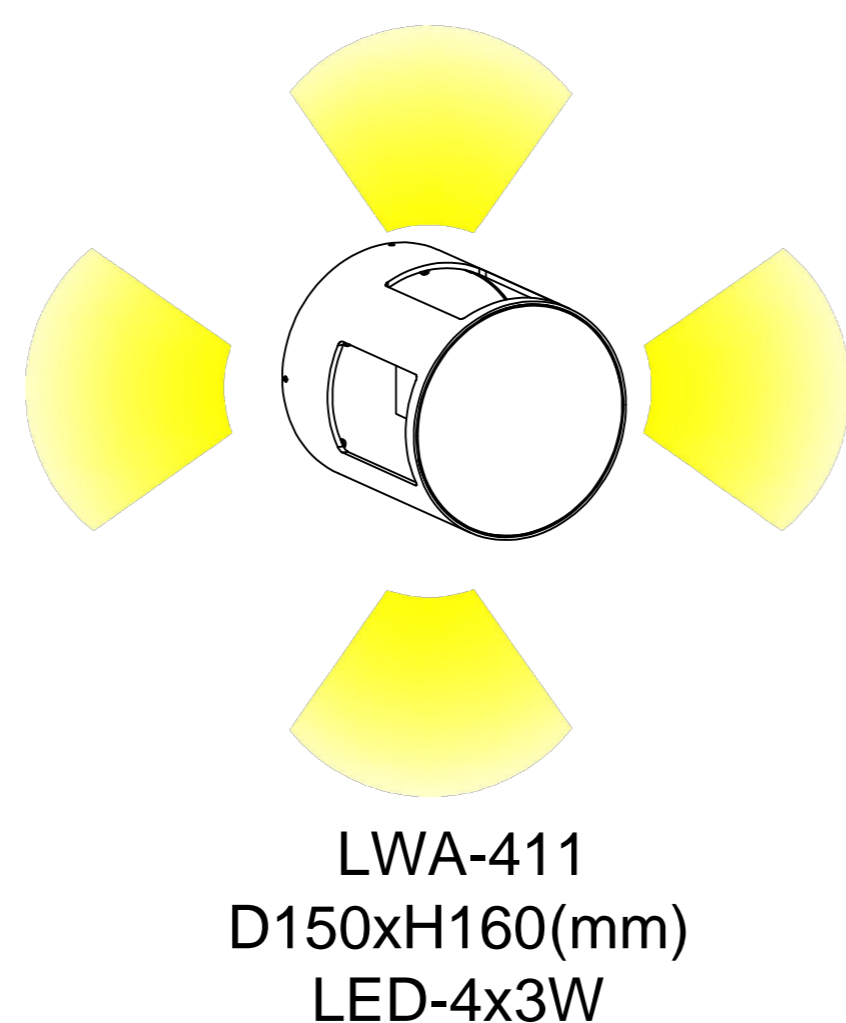
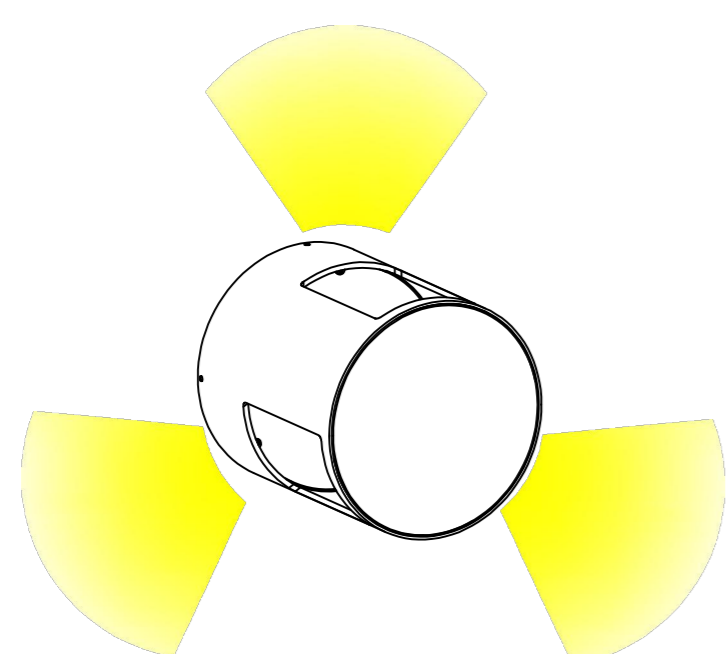
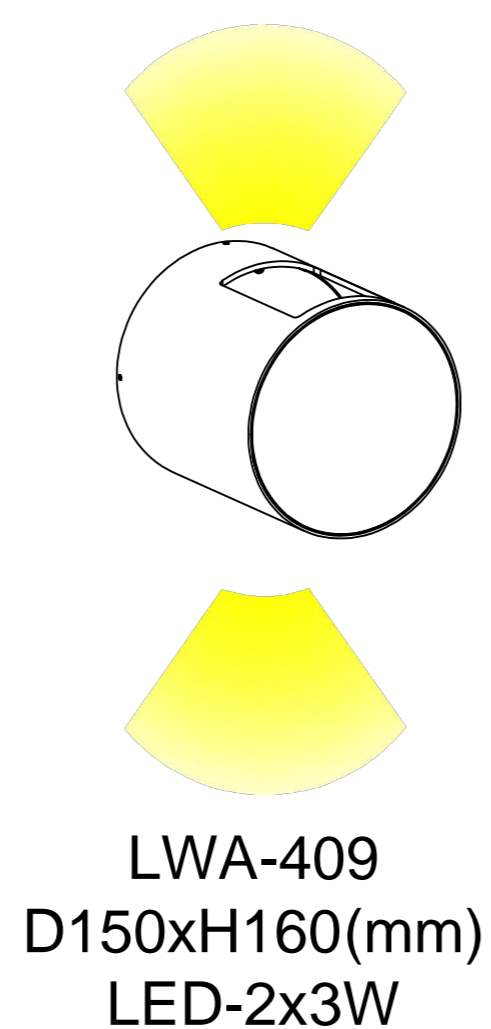
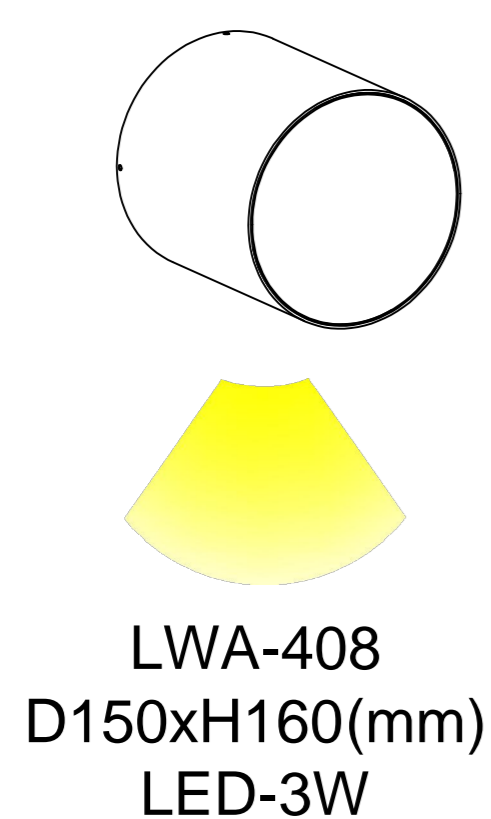
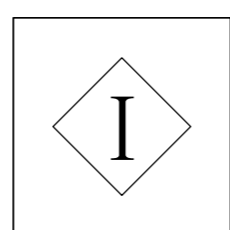
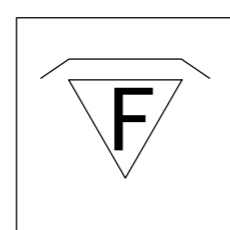
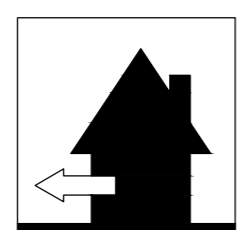
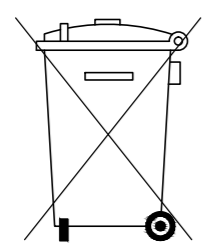

Lamp: CREE COB LED  
Color: 2700K/3000K/4000K/6000K  
Color rendering: Ra90  
Input: 100V-240V AC  
Current: Constant 300mA  
Frequency: 50/60Hz  
Watt: 3W/2x3W/3x3W/4x3W  
Life span: 20,000hrs  
Operating temp: -20°C--+40°C  
IP65  
Dimmable: NO

Cautions: a.Installed by qualified electrician  
b.Use only power-supply supplied  
by manufacturer for products guarantee