

INGCO

www.ingco.com

PRODUCT MANUAL

CORDLESS IMPACT WRENCH



CIWLI20135 CIWLI20135xy
UCIWLI20135 UCIWLI20135xy
x(blank,1,2,3,4,5,6,7,8,9,E,S,A,M)
y(blank,-1,-2,-3,-4,-5,-6,-7,-8,-9,E,S,A,M)



SCAN FOR VIDEO

GENERAL POWER TOOL SAFETY WARNINGS

⚠ WARNING! Read all safety warnings, instructions, illustrations and specifications provided with this power tool. *Failure to follow all instructions listed below may result in electric shock, fire and/or serious injury.*

Save all warnings and instructions for future reference.

The term "power tool" in the warnings refers to your mains-operated (corded) power tool or battery-operated (cordless) power tool.

1) Work area safety

- a) **Keep work area clean and well lit.** *Cluttered or dark areas invite accidents.*
- b) **Do not operate power tools in explosive atmospheres, such as in the presence of flammable liquids, gases or dust.** *Power tools create sparks which may ignite the dust or fumes.*
- c) **Keep children and bystanders away while operating a power tool.** *Distractions can cause you to lose control.*

2) Electrical safety

- a) **Power tool plugs must match the outlet. Never modify the plug in any way. Do not use any adapter plugs with earthed (grounded) power tools.** *Unmodified plugs and matching outlets will reduce risk of electric shock.*
- b) **Avoid body contact with earthed or grounded surfaces, such as pipes, radiators, ranges and refrigerators.** *There is an increased risk of electric shock if your body is earthed or grounded.*
- c) **Do not expose power tools to rain or wet conditions.** *Water entering a power tool will increase the risk of electric shock.*
- d) **Do not abuse the cord. Never use the cord for carrying, pulling or unplugging the power tool. Keep cord away from heat, oil, sharp edges or moving parts.** *Damaged or entangled cords increase the risk of electric shock.*
- e) **When operating a power tool outdoors, use an extension cord suitable for outdoor use.** *Use of a cord suitable for outdoor use reduces the risk of electric shock.*
- f) **If operating a power tool in a damp location is unavoidable, use a residual current device (RCD) protected supply.** *Use of an RCD reduces the risk of electric shock.*

3) Personal safety

- a) **Stay alert, watch what you are doing and use common sense when operating a power tool. Do not use a power tool while you are tired or under the influence of drugs, alcohol or medication. A moment of inattention while operating power tools may result in serious personal injury.**
- b) **Use personal protective equipment. Always wear eye protection. Protective equipment such as a dust mask, non-skid safety shoes, hard hat or hearing protection used for appropriate conditions will reduce personal injuries.**
- c) **Prevent unintentional starting. Ensure the switch is in the off-position before connecting to power source and/or battery pack, picking up or carrying the tool. Carrying power tools with your finger on the switch or energising power tools that have the switch on invites accidents.**
- d) **Remove any adjusting key or wrench before turning the power tool on. A wrench or a key left attached to a rotating part of the power tool may result in personal injury.**
- e) **Do not overreach. Keep proper footing and balance at all times. This enables better control of the power tool in unexpected situations.**
- f) **Dress properly. Do not wear loose clothing or jewellery. Keep your hair and clothing away from moving parts. Loose clothes, jewellery or long hair can be caught in moving parts.**
- g) **If devices are provided for the connection of dust extraction and collection facilities, ensure these are connected and properly used. Use of dust collection can reduce dust-related hazards.**
- h) **Do not let familiarity gained from frequent use of tools allow you to become complacent and ignore tool safety principles. A careless action can cause severe injury within a fraction of a second.**

4) Power tool use and care

- a) **Do not force the power tool. Use the correct power tool for your application. The correct power tool will do the job better and safer at the rate for which it was designed.**
- b) **Do not use the power tool if the switch does not turn it on and off. Any power tool that cannot be controlled with the switch is dangerous and must be repaired.**
- c) **Disconnect the plug from the power source and/or remove the battery**

pack, if detachable, from the power tool before making any adjustments, changing accessories, or storing power tools. *Such preventive safety measures reduce the risk of starting the power tool accidentally.*

- d) **Store idle power tools out of the reach of children and do not allow persons unfamiliar with the power tool or these instructions to operate the power tool.** *Power tools are dangerous in the hands of untrained users.*
- e) **Maintain power tools and accessories. Check for misalignment or binding of moving parts, breakage of parts and any other condition that may affect the power tool's operation. If damaged, have the power tool repaired before use.** *Many accidents are caused by poorly maintained power tools.*
- f) **Keep cutting tools sharp and clean.** *Properly maintained cutting tools with sharp cutting edges are less likely to bind and are easier to control.*
- g) **Use the power tool, accessories and tool bits etc. in accordance with these instructions, taking into account the working conditions and the work to be performed.** *Use of the power tool for operations different from those intended could result in a hazardous situation.*
- h) **Keep handles and grasping surfaces dry, clean and free from oil and grease.** *Slippery handles and grasping surfaces do not allow for safe handling and control of the tool in unexpected situations.*

5) Battery tool use and care

- a) **Recharge only with the charger specified by the manufacturer.** *A charger that is suitable for one type of battery pack may create a risk of fire when used with another battery pack.*
- b) **Use power tools only with specifically designated battery packs.** *Use of any other battery packs may create a risk of injury and fire.*
- c) **When battery pack is not in use, keep it away from other metal objects, like paper clips, coins, keys, nails, screws or other small metal objects, that can make a connection from one terminal to another.** *Shorting the battery terminals together may cause burns or a fire.*
- d) **Under abusive conditions, liquid may be ejected from the battery; avoid contact. If contact accidentally occurs, flush with water. If liquid contacts eyes, additionally seek medical help.** *Liquid ejected from the battery may cause irritation or burns.*

- e) **Do not use a battery pack or tool that is damaged or modified.** *Damaged or modified batteries may exhibit unpredictable behaviour resulting in fire, explosion or risk of injury.*
- f) **Do not expose a battery pack or tool to fire or excessive temperature.** *Exposure to fire or temperature above 130 °C may cause explosion.*
- g) **Follow all charging instructions and do not charge the battery pack or tool outside the temperature range specified in the instructions.** *Charging improperly or at temperatures outside the specified range may damage the battery and increase the risk of fire.*

6) Service

- a) **Have your power tool serviced by a qualified repair person using only identical replacement parts.** *This will ensure that the safety of the power tool is maintained.*
- b) **Never service damaged battery packs.** *Service of battery packs should only be performed by the manufacturer or authorized service providers*

BATTERY TOOL SAFETY WARNINGS

Save these instructions.

⚠ CAUTION!

Only use genuine original batteries. *Use of non-genuine batteries, or batteries that have been altered, may result in the battery bursting causing fires, personal injury, and damage. It will also void the warranty for the tool and charged and dark areas invite accidents.*

⚠ WARNING!

- a) **Do not dismantle, open or shred secondary cells or batteries.**
- b) **Keep batteries out of the reach of children.** *Battery usage by children should be supervised. Especially keep small batteries out of reach of small children.*
- c) **Seek medical advice immediately if a cell or a battery has been swallowed.**
- d) **Do not expose cells or batteries to heat or fire.** *Avoid storage in direct sunlight.*
- e) **Do not short-circuit a cell or a battery.** *Do not store cells or batteries haphazardly in a box or drawer where they may short-circuit each other or be short-circuited by other metal objects.*
- f) **Do not remove a cell or battery from its original packaging until required for use.**
- g) **Do not subject cells or batteries to mechanical shock.**
- h) **In the event of a cell leaking, do not allow the liquid to come in contact with the skin or eyes.** *If contact has been made, wash the affected area with copious amounts of water and seek medical advice.*
- i) **Do not use any charger other than that specifically provided for use with the equipment.**
- j) **Observe the plus (+) and minus (-) marks on the cell, battery and equipment and ensure correct use.**
- k) **Do not use any cell or battery which is not designed for use with the equipment.**
- l) **Do not mix cells of different manufacture, capacity, size or type within a device.**
- m) **Always purchase the battery recommended by the device manufacturer for the equipment.**
- n) **Keep cells and batteries clean and dry.**
- o) **Wipe the cell or battery terminals with a clean dry cloth if they become**

dirty.

- p) Secondary cells and batteries need to be charged before use.** *Always use the correct charger and refer to the manufacturer's instructions or equipment manual for proper charging instructions.*
- q) Do not leave a battery on prolonged charge when not in use.**
- r) After extended periods of storage, it may be necessary to charge and discharge the cells or batteries times to obtain maximum performance.**
- s) Retain the original product literature for future reference.**
- t) Use the cell or battery only in the application for which it was intended.**
- u) When possible, remove the battery from the equipment when not in use.**
- v) Dispose of properly.**

Tips for maintaining maximum battery life

- a) Charge the battery cartridge before completely discharged.** *Always stop tool operation and charge the battery cartridge when you notice less tool power.*
- b) Never recharge a fully charged battery cartridge.** *Overcharging shortens the battery service life.*
- c) Charge the battery cartridge with room temperature at 10°C-40°C (50°F-104°F).** *Let a hot battery cartridge cool down before charging it.*
- d) Charge the battery cartridge if you do not use it for a long period (more than six months).**

Important safety instructions for battery cartridge

- 1. Before using battery cartridge, read all instructions and cautionary markings on battery charger, battery, and) product using battery.**
- 2. Do not disassemble battery cartridge.**
- 3. If operating time has become excessively shorter, stop operating immediately.** *It may result in a risk of overheating, possible burns and even an explosion.*
- 4. If electrolyte gets into your eyes, rinse them out with clear water and seek medical attention right away.** *It may result in loss of your eyesight.*
- 5. Do not short the battery cartridge:**
 - *Do not touch the terminals with any conductive material.*
 - *Avoid storing battery cartridge in a container with other metal objects such as nails, coins, etc.*

- *Do not expose battery cartridge to water or rain.*
 - *A battery short can cause a large current flow, overheating, possible burns and even a breakdown.*
6. **Do not store the tool and battery cartridge in locations where the temperature may reach or exceed 50°C (122°F).**
 7. **Do not incinerate the battery cartridge even if it is severely damaged or is completely worn out.** *The battery cartridge can explode in a fire.*
 8. **Be careful not to drop or strike battery.**
 9. **Do not use a damaged battery.**
 10. **Follow your local regulations relating to disposal of battery.**

Tool / battery protection system

The tool is equipped with a tool/battery protection system. This system automatically cuts off power to the motor to extend tool and battery life. The tool will automatically stop during operation if the tool or battery is placed under one of the following conditions:

Overload protection

When the battery is operated in a manner that causes it to draw an abnormally high current, the tool automatically stops without any indication. In this situation, turn the tool off and stop the application that caused the tool to become overloaded. Then turn the tool on to restart.

Overheat protection

When the tool/battery is overheated, the tool stops automatically. In this situation, let the tool/battery cool before turning the tool on again.

Transportation

Batteries comply with all applicable shipping regulations as prescribed by industry and legal standards (for more information, check with the manufacturer).

Transporting batteries can possibly cause fire if the battery terminals inadvertently come in contact with conductive materials. When transporting batteries, make sure that the battery terminals are protected and well insulated from materials that could contact them and cause a short circuit.

The information provided in this section of the manual is provided in good faith and believed to be accurate at the time the document was created. However, no warranty, expressed or implied, is given. It is the buyer's responsibility to ensure

that its activities comply with the applicable regulations.

Protecting the environment

Separate collection. This product must not be disposed of with normal household waste.

Should you find one day that your product needs replacement, or if it is of no further use to you, do not dispose of it with household waste. Make this product available for separate collection.

Separate collection of used products and packaging allows materials to be recycled and used again. Re-use of recycled materials helps prevent environmental pollution and reduces the demand for raw materials.











Local regulations may provide for separate collection of electrical products from the household, at municipal waste sites or by the retailer when you purchase a new product.

Rechargeable battery pack

This long-life battery pack must be recharged when it fails to produce sufficient power on jobs which were easily done before. At the end of its technical life, discard it with due care for our environment:

- Run the battery pack down completely, then remove it from the tool.
- Lithium-ion cells are recyclable. Take them to your dealer or a local recycling station. The collected battery packs will be recycled or disposed of properly.

THE SYMBOLS IN INSTRUCTION MANUAL

	Double insulated for additional protection
	Read the instruction manual before using.
	CE conformity.
	Safety alert. Please only use the accessories supported by the manufacturer.
	Wear safety glasses, hearing protection and dust mask.
	Waste electrical products should not be disposed of with household waste. Please recycle where facilities exist. Check with your Local Authority or retailer for recycling advice.
	Charging the battery only below 40°C
	Always recycle batteries.
	Do not destroy battery by fire.
	Do not expose battery to water

ADDITIONAL SAFETY WARNING

Safety warnings

1. **Hold power tool by insulated gripping surfaces, when performing an operation where the fastener may contact hidden wiring.** Fasteners contacting a "live" wire may make exposed metal parts of the power tool "live" and could give the operator an electric shock.
2. **Always be sure you have a firm footing. Be sure no one is below when using the tool in high locations.**
3. **Hold the tool firmly.**
4. **Wear ear protectors.**
5. **Do not touch the bit or the work piece immediately after operation.** They may be extremely hot and could burn your skin.
6. **Keep hands away from rotating parts.**

RESIDUAL RISKS

Even when the power tool is used as prescribed it is not possible to eliminate all residual risk factors. The following hazards may arise in connection with the power tool's construction and design:

- a) Health defects resulting from vibration emission if the power tool is being used over longer period of time or not adequately managed and properly maintained.
- b) Injuries and damage to property to due to broken accessories that are suddenly dashed.

WARNING!

This power tool produces an electromagnetic field during operation. This field may under some circumstances interfere with active or passive medical implants. To reduce the risk of serious or fatal injury, we recommend persons with medical implants to consult their physician and the medical implant manufacturer before operating this power tool.

INTENDED USE

The machine is intended for driving in and loosening screws and bolts as well as for tightening and loosening nuts within the respective range of dimension.

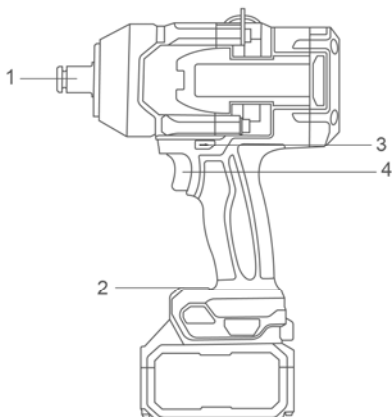
SPECIFICATIONS**Components**

- | | |
|----------------------|---|
| 1. 3/4" Square drive | 3. Forward and reverse rotation control |
| 2. LED work light | 4. Switch |

Technical specifications

Model No.	CIWLI20135 CIWLI20135xy	UCIWLI20135 UCIWLI20135xy
Square drive	19.05mm (3/4")	19.05mm (3/4")
No load speed	0-900/0-1200/0-1800rpm	0-900/0-1200/0-1800rpm
Blows per minute	0-1800/0-2000/0-2200bpm	0-1800/0-2000/0-2200bpm
Fastening torque	1350Nm	1350Nm
Nut busting torque	1900Nm	1900Nm
Fastening capacities (standard bolt)	M10-M30	M10-M30
Fastening capacities (high tensile bolt)	M10-M24	M10-M24

Model No. Note: x (blank, 1,2,3,4,5,6,7,8,9,E,S,A,M); y (blank, -1,-2,-3,-4,-5,-6,-7,-8,-9,E,S,A,M)

- Due to our continuing program of research and development, the specifications herein are subject to change without notice.
- Specifications and battery cartridge may differ from country to country.

⚠ WARNING!

Only use original battery pack and battery charger as below for this power tool:

Product	Battery pack		
Model No.	Type	Rated voltage	Rated capacity
FBLI2002 FBLI2002xy	Lithium-Ion	18.5V d.c., 20V Max	4.0Ah
FBLI2003 FBLI2003xy			5.0Ah

Model No. NOTE: x (blank, 1,2,3,4,5,6,7,8,9,E,S,A,M); y (blank, -1,-2,-3,-4,-5,-6,-7,-8,-9,E,S,A,M)

Product	Battery pack charger			
Model No.	Input power	Input voltage	Output rated voltage	Output rated current
FCLI2001 FCLI2001xy	50W	220-240V ~50/60Hz	20V d.c.	2A
UFCLI2001 UFCLI2001xy		110-120V ~50/60Hz		
FCLI20411 FCLI20411xy FCLI2034 FCLI2034xy	105W	220-240V ~50/60Hz	21V d.c.	4A
UFCLI20411 UFCLI20411xy UFCLI2034 UFCLI2034xy		110-120V ~50/60Hz		

Model No. NOTE: x (blank, 1,2,3,4,5,6,7,8,9,E,S,A,M); y (blank, -1,-2,-3,-4,-5,-6,-7,-8,-9,E,S,A,M)

OPERATION PICTURE

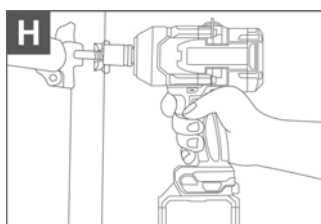
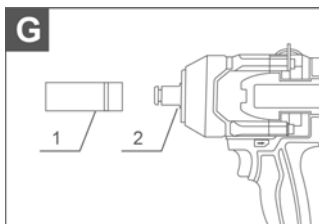
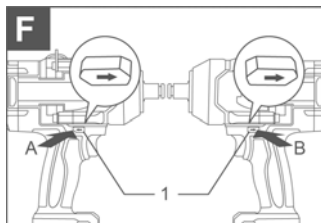
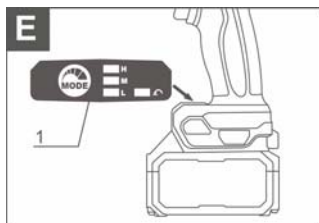
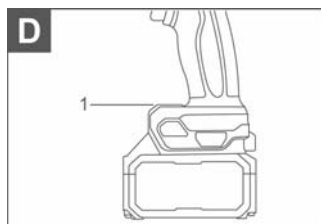
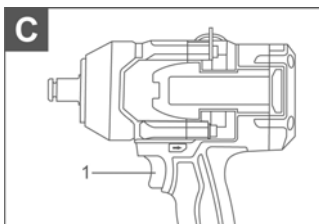
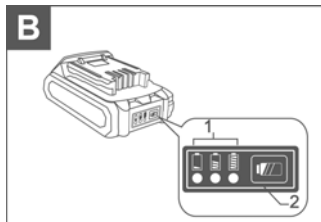
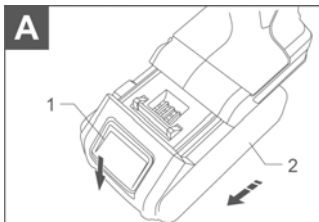

FUNCTION DESCRIPTION

⚠ CAUTION!

Always be sure that the tool is switched off and the battery cartridge is removed before adjusting or checking function on the tool

Installing or removing battery cartridge (see Figure A)

Figure A: 1. Button 2. Battery cartridge

⚠ CAUTION!

Always switch off the tool before installing or removing of the battery cartridge.

⚠ CAUTION!

Hold the tool and the battery cartridge firmly when installing or removing battery cartridge. Failure to hold the tool and the battery cartridge firmly may cause them to slip off your hands and result in damage to the tool and battery cartridge and a personal injury.

To remove the battery cartridge, slide it from the tool while sliding the button on the front of the cartridge.

To install the battery cartridge, align the tongue on the battery cartridge with the groove in the housing and slip it into place. Insert it all the way until it locks in place with a little click.

⚠ CAUTION!

Always install the battery cartridge fully until the red indicator cannot be seen. If not, it may accidentally fall out of the tool, causing injury to you or someone around you.





⚠ CAUTION!

Do not install the battery cartridge forcibly. If the cartridge does not slide in easily, it is not being inserted correctly.

Indicating the remaining battery capacity (see Figure B)

Figure B: 1. Indicator lamps 2. Check button

Press the check button on the battery cartridge to indicate the remaining battery capacity. The indicator lamps light up for few seconds.

Indicator lamps		Remaining capacity
 Lighted	 Off	
		>80%
		30% to 80%
		<30%

⚠ NOTE:

- Depending on the conditions of use and the ambient temperature, the indication may differ slightly from the actual capacity.

Tool / battery protection system

The tool is equipped with a tool/battery protection system. This system automatically cuts off power to the motor to extend tool and battery life. The tool will automatically stop during operation if the tool or battery is placed under one of the following conditions:

Overload protection

When the battery is operated in a manner that causes it to draw an abnormally high current, the tool automatically stops without any indication. In this situation, turn the tool off and stop the application that caused the tool to become overloaded. Then turn the tool on to restart.

Overheat protection

When the tool/battery is overheated, the tool stops automatically. In this situation, let the tool/battery cool before turning the tool on again.

Switch action:(see Figure C)

Figure C: 1. Switch trigger

⚠ CAUTION!

- Before inserting the battery cartridge into the tool, always check to see

that the switch trigger actuates properly and returns to the "OFF" position when released.

- To start the tool, simply pull the switch trigger. Tool speed is increased by increasing pressure on the switch trigger. Release the switch trigger to stop.

NOTE: The tool automatically stops if you keep pulling the switch trigger for about 6 minutes.

Electric brake

This tool is equipped with an electric brake. If the tool consistently fails to quickly stop after the switch trigger is released, have the tool serviced at a service center.

Lighting up the front lamp (see Figure D~E)

Figure D: 1. Lamp

Figure E: 1. Button

Changing the impact force

1. Low 2. Middle 3. High 4.Button 5.Auto-stop

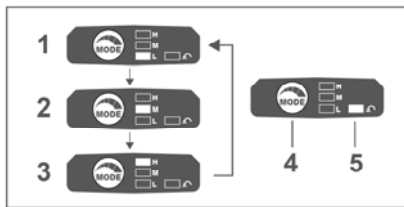

You can change the impact force in three steps: low, middle, high.

This allows a tightening suitable to the work. Every time the button is pressed, the number of blows changes in three steps.

When you change for counter clockwise rotation, click the mode to open the auto-stop function, the tool stops automatically as soon as it has loosened the bolt/nut

Reversing switch action (see Figure F)

1. Reversing switch lever

⚠ CAUTION

- Always check the direction of rotation before operation.
- Use the reversing switch only after the tool comes to a complete stop. Changing the direction of rotation before the tool stops may damage the tool.
- When not operating the tool, always set the reversing switch lever to the neutral position.

This tool has a reversing switch to change the direction of rotation. Depress the reversing switch lever from the A side for clockwise rotation or from the B side for counter clockwise rotation. When the reversing switch lever is in the neutral position, the switch trigger cannot be pulled.

Impact force grade displayed on panel	Maximum blows	Purpose	Example of application
High 	2200min ⁻¹ (/min)	Tightening when force and speed are desired	Tightening bolts
Middle 	2000min ⁻¹ (/min)	Tightening when force and speed are desired	Tightening bolts
Low 	1800min ⁻¹ (/min)	Tightening with less force to avoid screw thread breakage	Tightening sash screws, tightening small screws

⚠ NOTE

A mode is available only when the tool rotates clockwise. When rotating counterclockwise in A mode, the impact force and speed are the same as hard mode.

⚠ NOTE



When all lamps on the switch panel go out, the tool is turned off to save the

battery power. The impact force grade can be checked by pulling the switch trigger to the extent that the tool does not operate.

⚠ NOTE

While pulling the switch trigger, the impact force grade cannot be changed.

Specifications of each impact force grade

Impact force grade displayed on panel	Maximum blows	Application	Work
High 	2200min ⁻¹ (/min)	Tightening when force and speed are desired.	Assembling the big diameter bolt
Middle 	2000min ⁻¹ (/min)	Tightening when force and speed are desired.	Assembling the middle diameter bolt
Low 	1800min ⁻¹ (/min)	Tightening when you need fine adjustment with small diameter bolt.	Assembling the small diameter bolt

Assembly

⚠ CAUTION

Always be sure that the tool is switched off and the battery cartridge is removed before carrying out any work on the tool.

Selecting correct impact socket

Always use the correct size impact socket for bolts and nuts. An incorrect size impact socket will result in inaccurate and inconsistent fastening torque and/or damage to the bolt or nut.

Installing or removing impact socket

⚠ CAUTION

Make sure that the impact socket and the mounting portion are not damaged before installing the impact socket.

⚠ CAUTION

After inserting the impact socket, make sure that it is firmly secured. If it

comes out, do not use it.

(see Figure G)

Figure G: 1. Impact socket 2. Square drive

Align the hole in the side of the impact socket with the detent pin on the square drive and push the impact socket onto the square drive until it locks into place. Tap it lightly if required. To remove the impact socket, simply pull it off.

OPERATION

⚠ CAUTION

Always insert the battery cartridge all the way until it locks in place. If you can see the red indicator on the upper side of the button, it is not locked completely. Insert it fully until the red indicator cannot be seen. If not, it may accidentally fall out of the tool, causing injury to you or someone around you. (see Figure H)

Hold the tool firmly and place the impact socket over the bolt or nut. Turn the tool on and fasten for the proper fastening time.

The proper fastening torque may differ depending upon the kind or size of the bolt, the material of the work piece to be fastened, etc. The relation between fastening torque and fastening time is shown in the figures.

Proper fastening torque for standard bolt Proper fastening torque for high tensile bolt.

⚠ CAUTION!

- **Hold the tool pointed straight at the bolt or nut.**
- **Excessive fastening torque may damage the bolt/nut or impact socket. Before starting your job, always perform a test operation to determine the proper fastening time for your bolt or nut.**
- **If the tool is operated continuously until the battery cartridge has discharged, allow the tool to rest for 15 minutes before proceeding with a fresh battery cartridge.**

The fastening torque is affected by a wide variety of factors including the following. After fastening, always check the torque with a torque wrench.

When the battery cartridge is discharged almost completely, voltage will drop and the fastening torque will be reduced.

Impact socket

Failure to use the correct size impact socket will cause a reduction in the fastening torque.

A worm impact socket (wear on the hex end or square end) will cause a reduction in the fastening torque.

Bolt

Even though the torque coefficient and the class of bolt are the same, the proper fastening torque will differ according to the diameter of bolt.

Even though the diameters of bolts are the same, the proper fastening torque will

differ according to the torque coefficient, the class of bolt and the bolt length.

The use of the universal joint or the extension bar somewhat reduces the fastening force of the impact wrench. Compensate by fastening for a longer period of time.

The manner of holding the tool or the material of driving position to be fastened will affect the torque.

Operating the tool at low speed will cause a reduction in the fastening torque.

MAINTENANCE&MALFUNCTIONS

Possible malfunctions and methods of their eliminations

Malfunction	Probable causes	Actions
When the machine is turned on, the electric motor does not work.	<ul style="list-style-type: none"> • Switch failure • The power cord or wiring is broken, power cord plug malfunction; • No brush contact with the collector; • Wear/damage of brushes 	Disconnect the machine from the mains and contact a qualified specialist.
Formation of a circular fire on the collector	<ul style="list-style-type: none"> • Brush wear/damage of the brush holder; • Malfunction in the armature coil 	Disconnect the machine from the mains and contact a qualified specialist. Please don't repair the machine by your own.
When working, smoke or the smell of burning insulation appears from the ventilation openings.	<ul style="list-style-type: none"> • Malfunction in the electric motor coil; • Malfunction of the electrical part of the tool. 	
Increased noise in the gearbox	<ul style="list-style-type: none"> • Wear/breakage of gears or bearings 	
When the machine is turned on, the spindle does not rotate	<ul style="list-style-type: none"> • Gearbox failure. 	

Critical state criteria

Critical state criteria	Probable causes	Actions
Cracks on the surfaces of bearing and housing parts	Fatigue deformation of metal	Disconnect the machine from the mains and contact a qualified specialist. Please don't repair the machine by your own.
The power cord or plug is damaged	Overload or breakage	
Excessive wear or damage to the motor or reductor mechanism, or a combination of signs	Fatigue deformation of metal	

Critical state criteria

List of critical failures	Actions
Electric motor sparking	It is necessary to contact a qualified specialist
The appearance of extraneous noise	It is necessary to contact a qualified specialist
If the above malfunctions are detected, it is necessary to disconnect the machine from the mains and contact a qualified specialist	



MADE IN CHINA 1224.V03

   **INGCO Global** www.ingco.com

NEWWAY TECHNOLOGY (SUZHOU) CO., LIMITED
No. 20 Dagang Road, Fuqiao Town, Taicang City, China