

# INGCO

www.ingco.com

**PRODUCT  
MANUAL**

## **CORDLESS VACUUM CLEANER**



**CVLI2026 CVLI2026xy**  
**x (blank, 1,2,3,4,5,6,7,8,9,E,S,A,M);**  
**y (blank, -1,-2,-3,-4,-5,-6,-7,-8,-9,E,S,A,M)**



**GENERAL POWER TOOL SAFETY WARNINGS**

**⚠ WARNING!** Read all safety warnings, instructions, illustrations and specifications provided with this power tool. *Failure to follow all instructions listed below may result in electric shock, fire and/or serious injury.*

**Save all warnings and instructions for future reference.**

*The term "power tool" in the warnings refers to your mains-operated (corded) power tool or battery-operated (cordless) power tool.*

**1) Work area safety**

- a) **Keep work area clean and well lit.** *Cluttered or dark areas invite accidents.*
- b) **Do not operate power tools in explosive atmospheres, such as in the presence of flammable liquids, gases or dust.** *Power tools create sparks which may ignite the dust or fumes.*
- c) **Keep children and bystanders away while operating a power tool.** *Distractions can cause you to lose control.*

**2) Electrical safety**

- a) **Power tool plugs must match the outlet. Never modify the plug in any way. Do not use any adapter plugs with earthed (grounded) power tools.** *Unmodified plugs and matching outlets will reduce risk of electric shock.*
- b) **Avoid body contact with earthed or grounded surfaces, such as pipes, radiators, ranges and refrigerators.** *There is an increased risk of electric shock if your body is earthed or grounded.*
- c) **Do not expose power tools to rain or wet conditions.** *Water entering a power tool will increase the risk of electric shock.*
- d) **Do not abuse the cord. Never use the cord for carrying, pulling or unplugging the power tool. Keep cord away from heat, oil, sharp edges or moving parts.** *Damaged or entangled cords increase the risk of electric shock.*
- e) **When operating a power tool outdoors, use an extension cord suitable for outdoor use.** *Use of a cord suitable for outdoor use reduces the risk of electric shock.*
- f) **If operating a power tool in a damp location is unavoidable, use a residual current device (RCD) protected supply.** *Use of an RCD reduces the risk of electric shock.*

### 3) Personal safety

- a) **Stay alert, watch what you are doing and use common sense when operating a power tool. Do not use a power tool while you are tired or under the influence of drugs, alcohol or medication. A moment of inattention while operating power tools may result in serious personal injury.**
- b) **Use personal protective equipment. Always wear eye protection. Protective equipment such as a dust mask, non-skid safety shoes, hard hat or hearing protection used for appropriate conditions will reduce personal injuries.**
- c) **Prevent unintentional starting. Ensure the switch is in the off-position before connecting to power source and/or battery pack, picking up or carrying the tool. Carrying power tools with your finger on the switch or energising power tools that have the switch on invites accidents.**
- d) **Remove any adjusting key or wrench before turning the power tool on. A wrench or a key left attached to a rotating part of the power tool may result in personal injury.**
- e) **Do not overreach. Keep proper footing and balance at all times. This enables better control of the power tool in unexpected situations.**
- f) **Dress properly. Do not wear loose clothing or jewellery. Keep your hair and clothing away from moving parts. Loose clothes, jewellery or long hair can be caught in moving parts.**
- g) **If devices are provided for the connection of dust extraction and collection facilities, ensure these are connected and properly used. Use of dust collection can reduce dust-related hazards.**
- h) **Do not let familiarity gained from frequent use of tools allow you to become complacent and ignore tool safety principles. A careless action can cause severe injury within a fraction of a second.**

### 4) Power tool use and care

- a) **Do not force the power tool. Use the correct power tool for your application. The correct power tool will do the job better and safer at the rate for which it was designed.**
- b) **Do not use the power tool if the switch does not turn it on and off. Any power tool that cannot be controlled with the switch is dangerous and must be repaired.**
- c) **Disconnect the plug from the power source and/or remove the battery**

pack, if detachable, from the power tool before making any adjustments, changing accessories, or storing power tools. *Such preventive safety measures reduce the risk of starting the power tool accidentally.*

- d) **Store idle power tools out of the reach of children and do not allow persons unfamiliar with the power tool or these instructions to operate the power tool.** *Power tools are dangerous in the hands of untrained users.*
- e) **Maintain power tools and accessories. Check for misalignment or binding of moving parts, breakage of parts and any other condition that may affect the power tool's operation. If damaged, have the power tool repaired before use.** *Many accidents are caused by poorly maintained power tools.*
- f) **Keep cutting tools sharp and clean.** *Properly maintained cutting tools with sharp cutting edges are less likely to bind and are easier to control.*
- g) **Use the power tool, accessories and tool bits etc. in accordance with these instructions, taking into account the working conditions and the work to be performed.** *Use of the power tool for operations different from those intended could result in a hazardous situation.*
- h) **Keep handles and grasping surfaces dry, clean and free from oil and grease.** *Slippery handles and grasping surfaces do not allow for safe handling and control of the tool in unexpected situations.*

##### 5) Battery tool use and care

- a) **Recharge only with the charger specified by the manufacturer.** *A charger that is suitable for one type of battery pack may create a risk of fire when used with another battery pack.*
- b) **Use power tools only with specifically designated battery packs.** *Use of any other battery packs may create a risk of injury and fire.*
- c) **When battery pack is not in use, keep it away from other metal objects, like paper clips, coins, keys, nails, screws or other small metal objects, that can make a connection from one terminal to another.** *Shorting the battery terminals together may cause burns or a fire.*
- d) **Under abusive conditions, liquid may be ejected from the battery; avoid contact. If contact accidentally occurs, flush with water. If liquid contacts eyes, additionally seek medical help.** *Liquid ejected from the battery may cause irritation or burns.*

- e) **Do not use a battery pack or tool that is damaged or modified.** *Damaged or modified batteries may exhibit unpredictable behaviour resulting in fire, explosion or risk of injury.*
- f) **Do not expose a battery pack or tool to fire or excessive temperature.** *Exposure to fire or temperature above 130 °C may cause explosion.*
- g) **Follow all charging instructions and do not charge the battery pack or tool outside the temperature range specified in the instructions.** *Charging improperly or at temperatures outside the specified range may damage the battery and increase the risk of fire.*

## **6) Service**

- a) **Have your power tool serviced by a qualified repair person using only identical replacement parts.** *This will ensure that the safety of the power tool is maintained.*
- b) **Never service damaged battery packs.** *Service of battery packs should only be performed by the manufacturer or authorized service providers*

## BATTERY TOOL SAFETY WARNINGS

Save these instructions.

### **⚠ CAUTION!**

**Only use genuine original batteries.** *Use of non-genuine batteries, or batteries that have been altered, may result in the battery bursting causing fires, personal injury, and damage. It will also void the warranty for the tool and charged and dark areas invite accidents.*

### **Tips for maintaining maximum battery life**

- Charge the battery cartridge before completely discharged. Always stop tool operation and charge the battery cartridge when you notice less tool power.
- Never recharge a fully charged battery cartridge. Overcharging shortens the battery service life.
- Charge the battery cartridge with room temperature at 10°C - 40°C (50°F - 104°F). Let a hot battery cartridge cool down before charging it.
- Charge the battery cartridge if you do not use it for a long period (more than six months).











### **Important safety instructions for battery cartridge**

- Before using battery cartridge, read all instructions and cautionary markings on (1) battery charger, (2) battery, and (3) product using battery.
- Do not disassemble battery cartridge.
- If operating time has become excessively shorter, stop operating immediately. It may result in a risk of overheating, possible burns and even an explosion.
- If electrolyte gets into your eyes, rinse them out with clear water and seek medical attention right away. It may result in loss of your eyesight.
- Do not short the battery cartridge:
- Do not touch the terminals with any conductive material.
- Avoid storing battery cartridge in a container with other metal objects such as nails, coins, etc.
- Do not expose battery cartridge to water or rain. A battery short can cause a large current flow, over- heating, possible burns and even a breakdown.
- Do not store the tool and battery cartridge in locations where the temperature may reach or exceed 50°C (122°F).
- Do not incinerate the battery cartridge even if it is severely damaged or is

completely worn out. The battery cartridge can explode in a fire.

- k) Be careful not to drop or strike battery.
- l) Do not use a damaged battery.
- m) 10. Follow your local regulations relating to disposal of battery.

## THE SYMBOLS IN INSTRUCTION MANUAL

	Double insulated for additional protection
	Read the instruction manual before using.
	CE conformity.
	Safety alert. Please only use the accessories supported by the manufacturer.
	Wear safety glasses, hearing protection and dust mask.
	Waste electrical products should not be disposed of with household waste. Please recycle where facilities exist. Check with your Local Authority or retailer for recycling advice.
	Charging the battery only below 40°C
	Always recycle batteries.
	Do not destroy battery by fire.
	Do not expose battery to water

**ADDITIONAL SAFETY WARNINGS****⚠ WARNING!**

- Read all safety warnings and all instructions. Failure to follow the warnings and instructions may result in electric shock, fire and/or serious injury.
- This appliance can be used by children aged from 8 years and above and persons with reduced physical, sensory or mental capabilities or lack of experience and knowledge if they have been given supervision or instruction concerning use of the appliance in a safe way and understand the hazards involved. Children shall not play with the appliance. Cleaning and user maintenance shall not be made by children without supervision.

**⚠ WARNING!**

Do not vacuum materials that are harmful to one's health, e.g., dust from beech or oak wood, masonry dust, asbestos. These materials are considered carcinogenic. Inform yourself about the valid regulations/laws for your country concerning the handling of materials that are hazardous to one's health.

- a) The product may only be repaired by qualified service personnel.
- b) The product may not be taken apart nor be changed.
- c) Do not place the product so that it may fall down into water or another liquid.
- d) Do not put any items containing water on the product, for example a flower vase or a soda can.
- e) Disconnect the battery pack when the vacuum cleaner is not in use.
- f) Check the battery pack to make sure it matches the vacuum cleaner correctly.
- g) The vacuum cleaner is not a toy, do not let children use it without supervision!
- h) Never leave the vacuum cleaner unattended when it is turned on.
- i) The vacuum cleaner is made for indoor usage; protect it from water and dampness.
- j) Use the vacuum cleaner only after having received sufficient information on its usage. A thorough introduction reduces operating errors and injuries.
- k) The vacuum cleaner is suitable only for vacuuming dry materials. The penetration of liquids increases the risk of an electric shock.
- l) The vacuum cleaner may only be used and stored indoors. The penetration of rain or moisture into the vacuum cleaner lid increases the risk of an electric shock.

- m) Do not vacuum hot or burning dusts, and in rooms with an explosion hazard. Dust can ignite or explode.
- n) Do not use the vacuum cleaner in explosive environments.
- o) Remove the battery before cleaning or performing maintenance on the vacuum cleaner, making tool adjustments, charging accessories or storing the vacuum cleaner. The safety measure prevents the vacuum cleaner from being started accidentally.
- p) Have the vacuum cleaner repaired only through qualified specialists and only using original spare parts. This ensures the safety of your vacuum cleaner when maintained.

## RESIDUAL RISKS

Even when the power tool is used as prescribed it is not possible to eliminate all residual risk factors. The following hazards may arise in connection with the power tool's construction and design:

- a) Health defects resulting from vibration emission if the power tool is being used over a longer period of time or not adequately managed and properly maintained.
- b) Injuries and damage to property due to broken accessories that are suddenly dashed.

### **WARNING!**

**This power tool produces an electromagnetic field during operation. This field may under some circumstances interfere with active or passive medical implants. To reduce the risk of serious or fatal injury, we recommend persons with medical implants to consult their physician and the medical implant manufacturer before operating this power tool.**

## INTENDED USE

Mainly used to quickly suck out the dust at the bottom of the bed, the bottom of the sofa and other hidden corners.

## SPECIFICATIONS

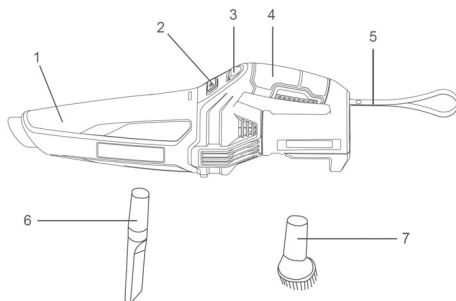

### Components

- |                                |                   |
|--------------------------------|-------------------|
| 1. Dust cup                    | 5. Sling          |
| 2. Release button for dust cup | 6. Crevice nozzle |
| 3. ON/OFF switch               | 7. Floor nozzle   |
| 4. Host                        |                   |

### Accessories

With a USB Type-C cable

### Technical specifications

Model No.	CVLI2026 CVLI2026xy
Voltage	12V
Dust capacity	0.5L
Vacuum pressure	≥7kPa

**Model No. NOTE:** x (blank, 1,2,3,4,5,6,7,8,9,E,S,A,M); y (blank, -1,-2,-3,-4,-5,-6,-7,-8,-9,E,S,A,M)

- Due to our continuing program of research and development, the specifications herein are subject to change without notice.

## OPERATION PICTURE

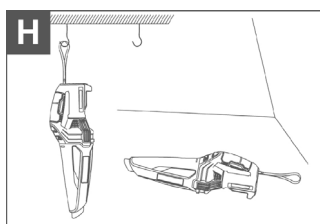
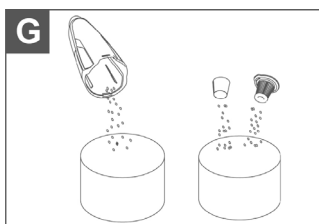
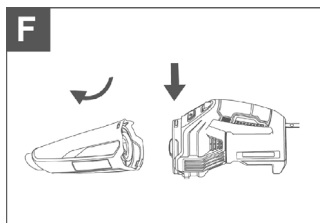
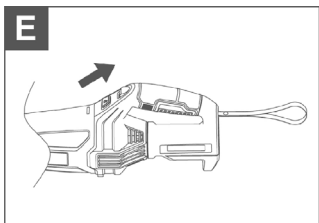
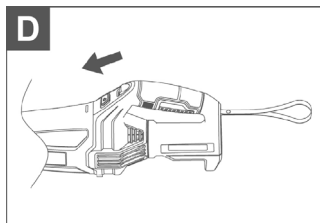
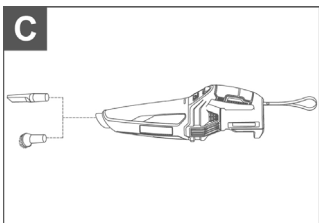
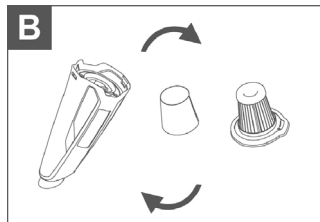
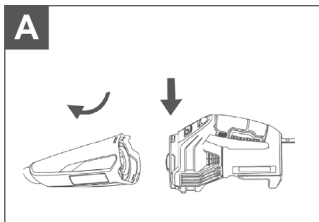

## OPERATION

### Check the filters

Press the release button for dust cup, open the dust cup. (see Figure A)

Take out the dust cup cover from the dust cup(step1) turn off the filter net from the dust cup cover(step2), check and turn tight the HEPA filter on the dust cup cover. (see Figure B)

Turn tight the filter net on the dust cup cover(step3), put in the dust cup cover to the dust cup(step4). (see Figure B)

Put the dust cup on the product.

### Mounting VAC accessories (see Figure C)

The vacuum cleaner accessories can be connected directly to the dust.

### Starting operation (see Figure D~E)

To switch on the vacuum cleaner, press the ON/OFF button; to switch off the vacuum cleaner, press the ON/OFF button.

## Maintenance

### Keep the vacuum cleaner clean

For safe and proper working, always keep the vacuum cleaner and ventilation slots clean. Clean the vacuum cleaner housing from time to time using a cloth.

### Emptying the dust cup

To maintain the optimum performance of the vacuum cleaner, clean the dust cup after each use.

Press the release button for dust cup, open the dust cup. (see Figure F)

Take out the dust cup cover from the dust cup, and clean the dust cup/ filter net/HEPA filter. (see Figure G)

If the HEPA filter damages replace the HEPA filter in time.

If the HEPA filter uses too many times, please replace the filter in time.

### Storage (see Figure H)

There is a sling on the vacuum cleaner that can be hung on a reliable hook.

## MAINTENANCE&MALFUNCTIONS

### Possible malfunctions and methods of their eliminations

Malfunction	Probable causes	Actions
When the machine is turned on, the electric motor does not work.	<ul style="list-style-type: none"> <li>● Switch failure</li> <li>● The power cord or wiring is broken, power cord plug malfunction;</li> <li>● No brush contact with the collector;</li> <li>● Wear/damage of brushes</li> </ul>	Disconnect the machine from the mains and contact a qualified specialist.
Formation of a circular fire on the collector	<ul style="list-style-type: none"> <li>● Brush wear/damage of the brush holder;</li> <li>● Malfunction in the armature coil</li> </ul>	Disconnect the machine from the mains and contact a qualified specialist. Please don't repair the machine by your own.
When working, smoke or the smell of burning insulation appears from the ventilation openings.	<ul style="list-style-type: none"> <li>● Malfunction in the electric motor coil;</li> <li>● Malfunction of the electrical part of the tool.</li> </ul>	
Increased noise in the gearbox	<ul style="list-style-type: none"> <li>● Wear/breakage of gears or bearings</li> </ul>	
When the machine is turned on, the spindle does not rotate	<ul style="list-style-type: none"> <li>● Gearbox failure.</li> </ul>	

### Critical state criteria

Critical state criteria	Probable causes	Actions
Cracks on the surfaces of bearing and housing parts	Fatigue deformation of metal	Disconnect the machine from the mains and contact a qualified specialist. Please don't repair the machine by your own.
The power cord or plug is damaged	Overload or breakage	
Excessive wear or damage to the motor or reductor mechanism, or a combination of signs	Fatigue deformation of metal	

### Critical state criteria

List of critical failures	Actions
Electric motor sparking	It is necessary to contact a qualified specialist
The appearance of extraneous noise	It is necessary to contact a qualified specialist
If the above malfunctions are detected, it is necessary to disconnect the machine from the mains and contact a qualified specialist	





MADE IN CHINA 1224.V04

   INGCO Global

[www.ingco.com](http://www.ingco.com)

NEWWAY TECHNOLOGY (SUZHOU) CO., LIMITED

No. 20 Dagang Road, Fuqiao Town, Taicang City, China