

EN

With your inspiring rating, COSTWAY will be more consistent to offer you EASY SHOPPING EXPERIENCE, GOOD PRODUCTS and EFFICIENT SERVICE!

DE

Mit Ihrer inspirierenden Bewertung wird COSTWAY konsistenter sein, um Ihnen EIN SCHÖNES EINKAUFSERLEBNIS, GUTE PRODUKTE und EFFIZIENTEN SERVICE zu bieten!

FR

Avec votre évaluation inspirante, COSTWAY continuera à fournir une EXPÉRIENCE D'ACHAT PRATIQUE, des PRODUITS DE QUALITÉ et un SERVICE EFFICACE !

ES

Con su calificación inspiradora, COSTWAY será más consistente para ofrecerle EXPERIENCIA DE COMPRA FÁCIL, BUENOS PRODUCTOS y SERVICIO EFICIENTE.

IT

Con la tua valutazione incoraggiante, COSTWAY sarà più coerente per offrirti ESPERIENZA DI ACQUISTO FACILE, BUONI PRODOTTI e SERVIZIO EFFICIENTE!

PL

Dzięki twojej opinii COSTWAY będzie mógł oferować jeszcze WYGODNIEJSZE ZAKUPY, LEPSZE PRODUKTY i SPRAWNIEJSZĄ OBSŁUGĘ KLIENTA.

US office: Fontana **UK** office: Ipswich

DE office: FDS GmbH, Neuer Höltingbaum 36, 22143 Hamburg, Deutschland

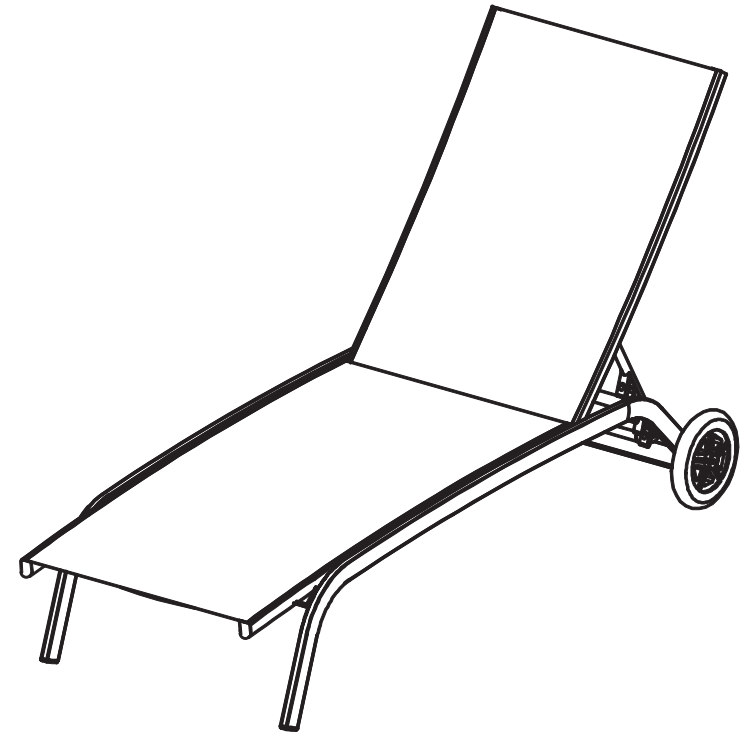

FR office: Saint Vigor d'Ymonville **PL** office: Gdańsk





**USER'S MANUAL/HANDBUCH
/MANUEL DE L'UTILISATEUR/MANUAL DEL USUARIO
/MANUALE UTENTE/INSTRUKCJA OBSŁUGI**



NP10206



Chaise Lounge Chair/Liege/Chaise Longue
/Tumbona/Lettino a Sdraio/Leżak

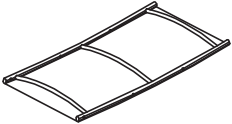
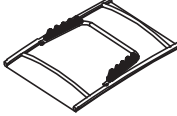

A		1	B		1
---	---	---	---	---	---



C		1	D		2
---	---	---	---	---	---



E		1	F		1
---	---	---	---	---	---



G		2	H	 M6*38	8
---	---	---	---	--	---

J	 M6*18	12	K	 M8*73	2
---	--	----	---	--	---

L	 M8	4	M	 M6	20
---	---	---	---	---	----

N	 M8	2	O	 M8	2
---	---	---	---	---	---

P		20	Q		2
---	---	----	---	---	---

R		1	S		1
---	---	---	---	---	---

T		2
---	---	---

- EN- Put the screws in the holes, tighten the screws, but not too tight.
- DE- Setzen Sie die Schrauben in die Löcher ein, ziehen Sie die Schrauben fest, aber nicht zu fest.
- FR- Mettez les vis dans les trous, serrez les vis, mais pas trop fort.
- ES- Coloque los tornillos en los agujeros, apriete los tornillos, pero no demasiado.
- IT- Mettere le viti nei fori, stringere le viti, ma non troppo.
- PL- Włóż śruby w otwory i lekko je dokręć. Nie używaj zbyt dużej siły.

①

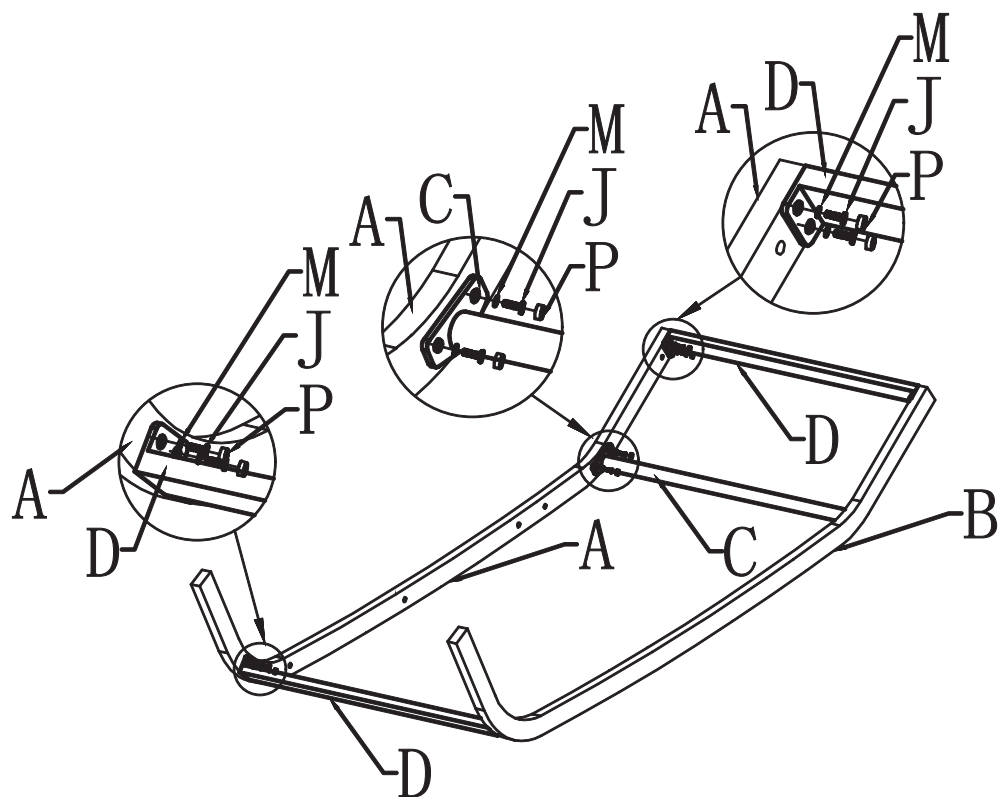

②

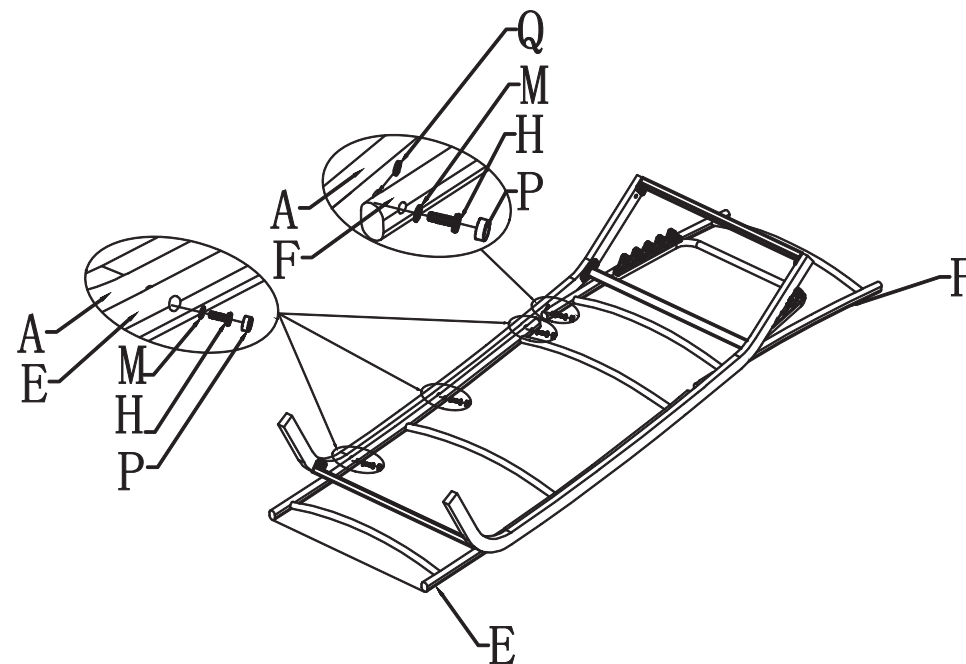

③

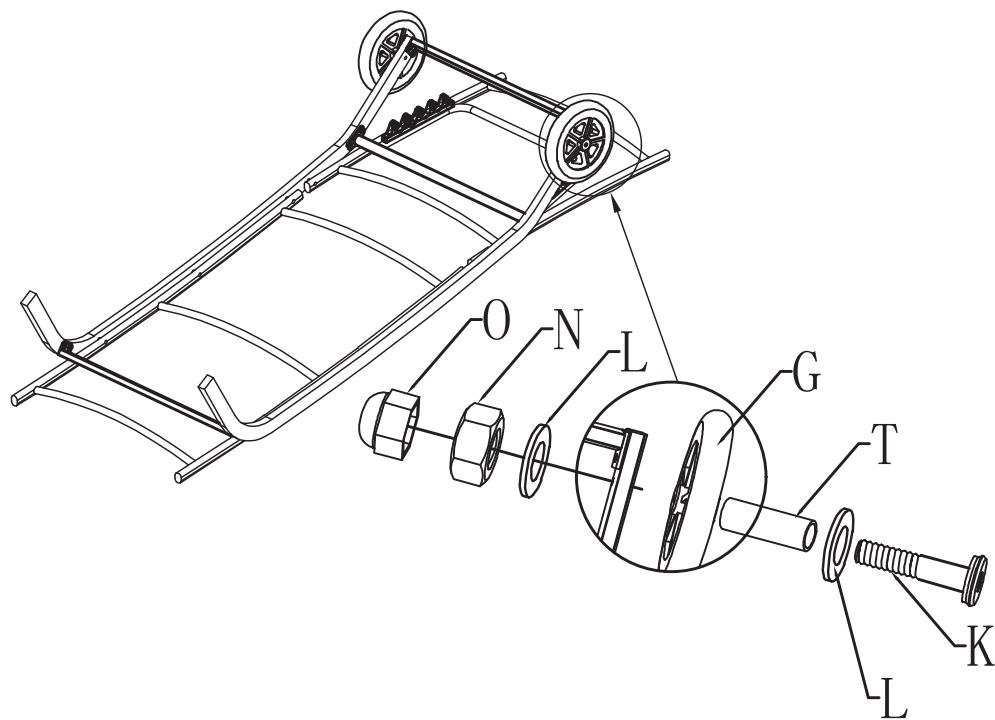

④

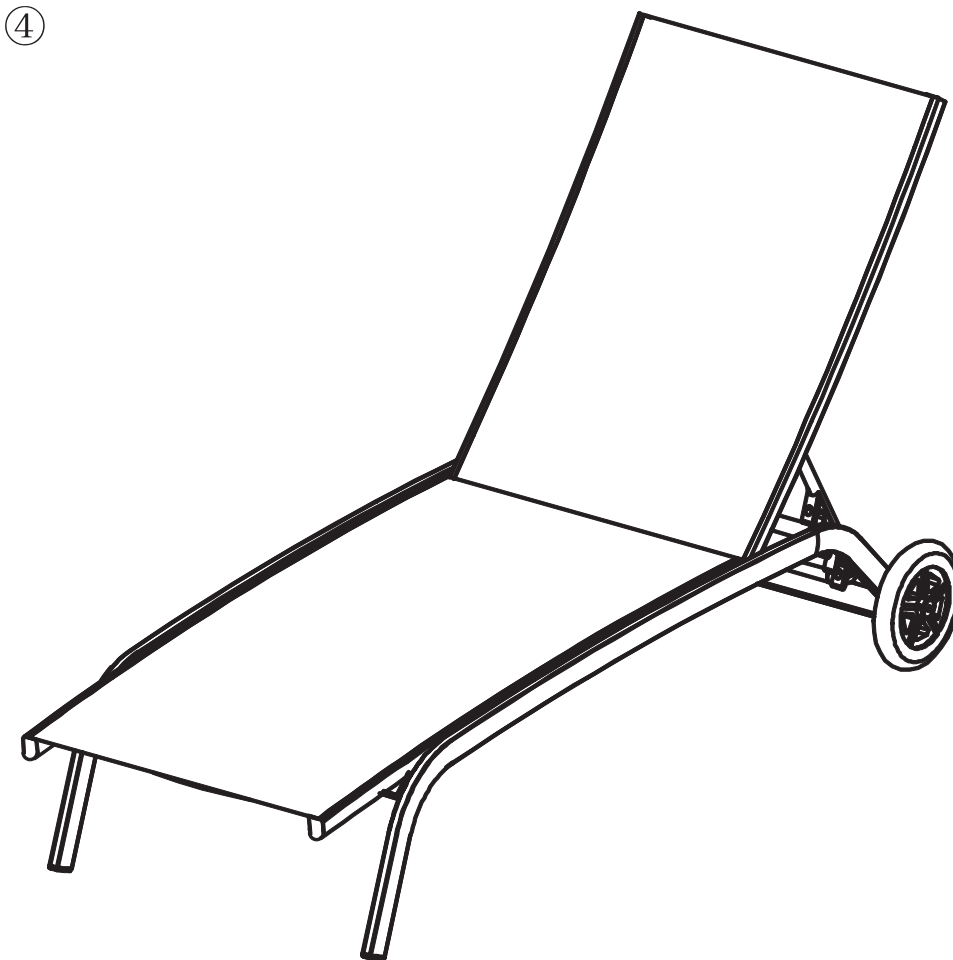

-ES- Then adjust the balance of it, tighten all the screws.

-DE- Stellen Sie dann das Gleichgewicht der Liege ein und ziehen Sie alle Schrauben fest.

-FR- Puis réglez l'équilibre de la chaise longue, serrez toutes les vis.

-ES- Luego ajuste el equilibrio de la tumbona, y apriete todos los tornillos.

-IT- Poi regolare l'equilibrio del lettino a sdraio, stringere tutte le viti.

-PL- Następnie ustaw leżak we właściwej pozycji i dokręć wszystkie śruby.