

Upholstered Bar Stools Set of 2  
Ensemble de 2 Tabourets de Bar Rembourrés

**JV11284**

EN



## Before You Start

- ⚠ Please read all instructions carefully.
- ⚠ Retain instructions for future reference.
- ⚠ Separate and count all parts and hardware.
- ⚠ Read through each step carefully and follow the proper order.
- ⚠ We recommend that, where possible, all items are assembled near to the area in which they will be placed in use, to avoid moving the product unnecessarily once assembled.
- ⚠ Always place the product on a flat, steady and stable surface.
- ⚠ Keep all small parts and packaging materials for this product away from babies and children as they potentially pose a serious choking hazard.

FR



## Avant de Commencer

- ⚠ Veuillez lire attentivement toutes les instructions.
- ⚠ Conservez les instructions pour vous y référer ultérieurement.
- ⚠ Vérifiez toutes les pièces et les accessoires.
- ⚠ Lisez attentivement chaque étape et suivez l'ordre correct.
- ⚠ Nous recommandons que, dans la mesure du possible, tous les produits soient assemblés à proximité de la zone où ils seront utilisés, afin d'éviter tout déplacement inutile du produit une fois assemblé.
- ⚠ Placez toujours le produit sur une surface plane et stable.
- ⚠ Conservez toutes les petites pièces de ce produit et les matériaux d'emballage hors de portée des bébés et des enfants, car ils pourraient présenter un risque d'étouffement.

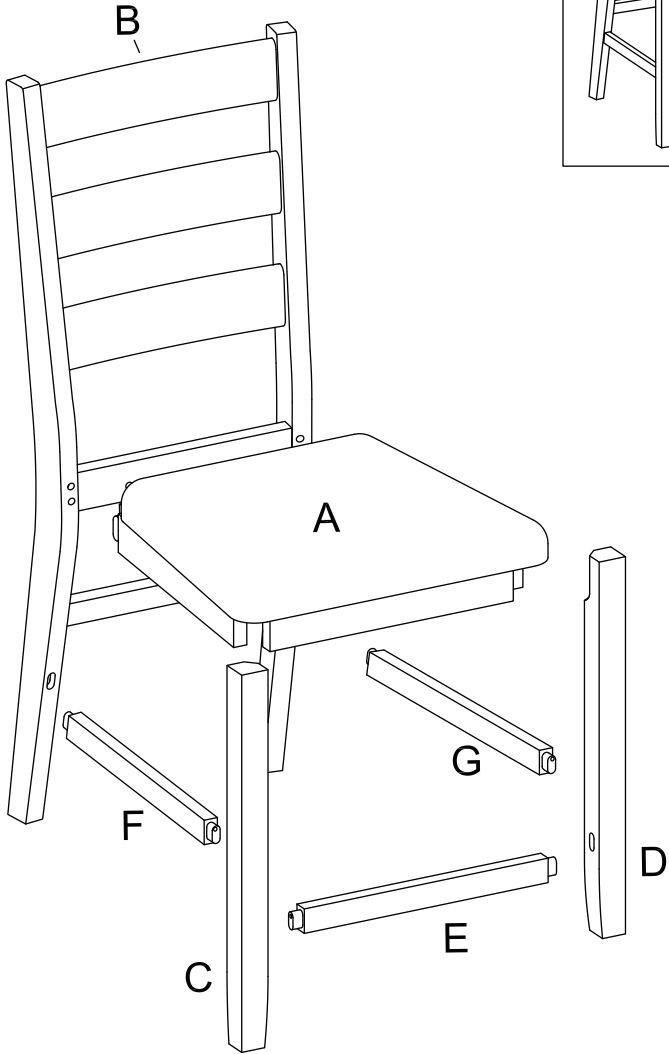
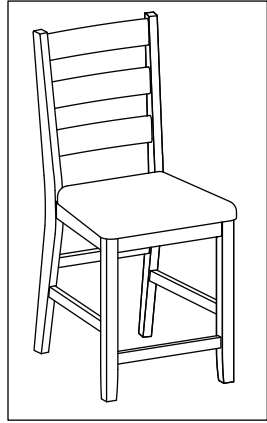

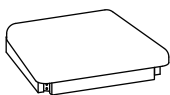

SEAT  
/SIÈGE

(A) x2

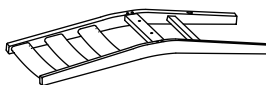

CHAIR BACK  
/DOSSIER DE CHAISE

(B) x2

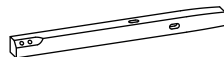

LEFT LEG  
/PIED GAUCHE

(C) x2

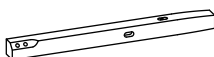

RIGHT LEG  
/PIED DROIT

(D) x2



FRONT  
STRETCHER  
/CIVIÈRE AVANT

(E) x2



LEFT  
STRETCHER  
/CIVIÈRE  
GAUCHE

(F) x2



RIGHT  
STRETCHER  
/CIVIÈRE  
DROITE

(G) x2

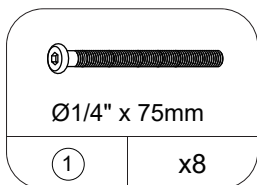

Ø1/4" x 75mm

(1)

x8

BOLT  
/BOULON

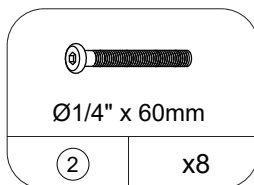

Ø1/4" x 60mm

(2)

x8

BOLT  
/BOULON

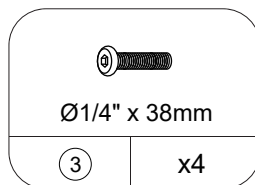

Ø1/4" x 38mm

(3)

x4

BOLT  
/BOULON

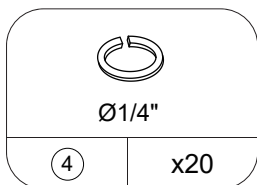

Ø1/4"

(4)

x20

SPRING WASHER  
/RONDELLE ÉLASTIQUE

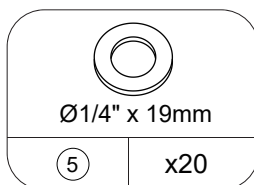

Ø1/4" x 19mm

(5)

x20

FLAT WASHER  
/RONDELLE PLATE

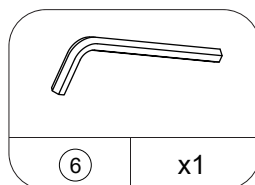

(6)

x1

Allen Key  
/Clé Allen

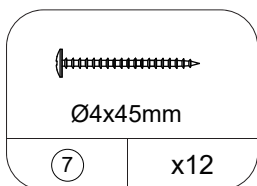

Ø4x45mm

(7)

x12



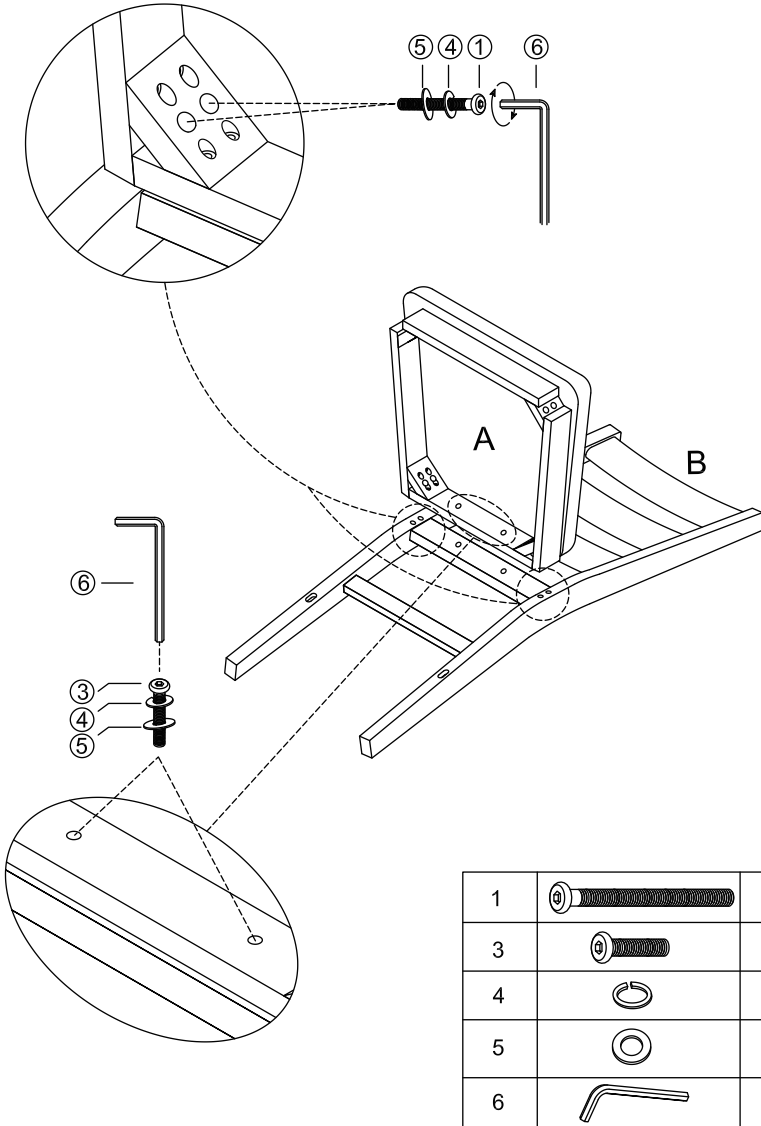

SCREW  
/VIS

# 1 x2

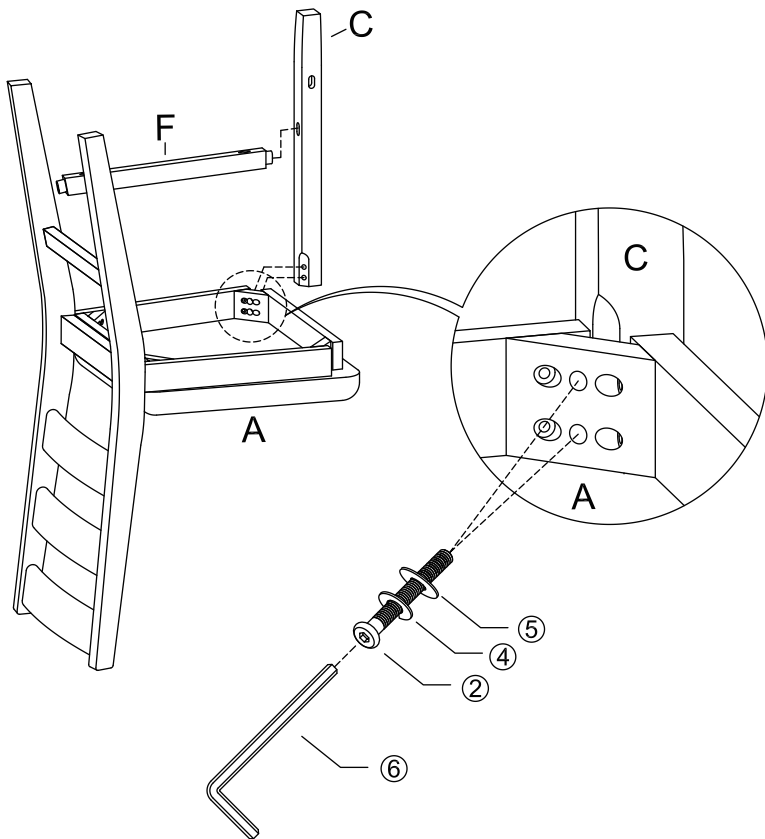





**2** x2

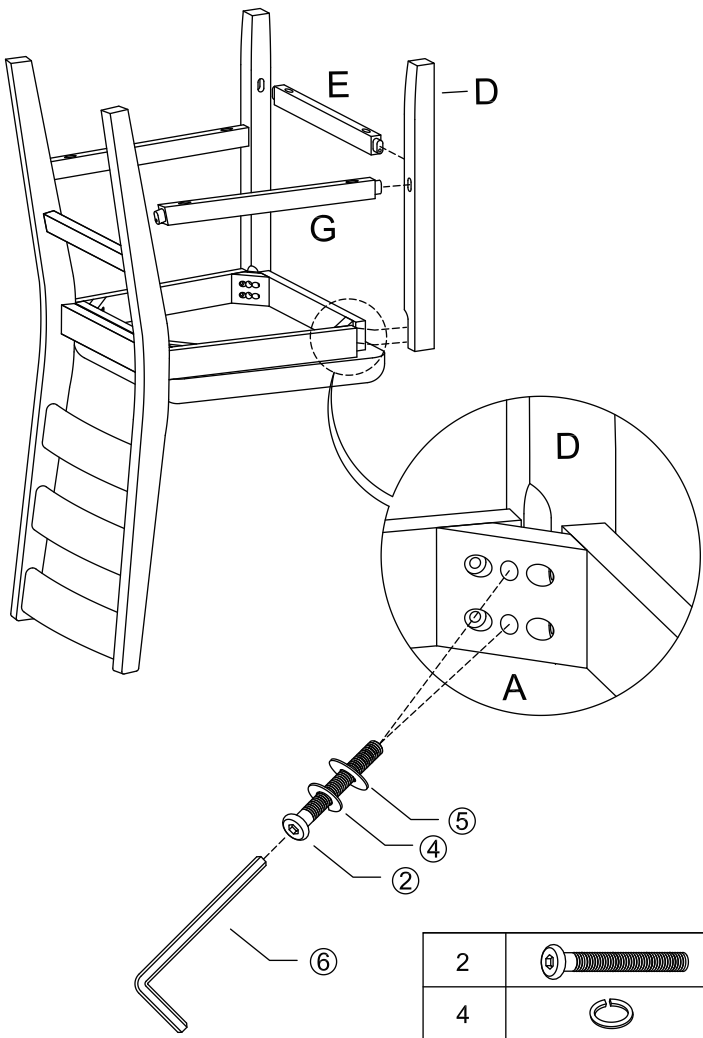

2		x2
4		x2
5		x2
6		x1

**3** x2



2		x2
4		x2
5		x2
6		x1

**4** **x2**

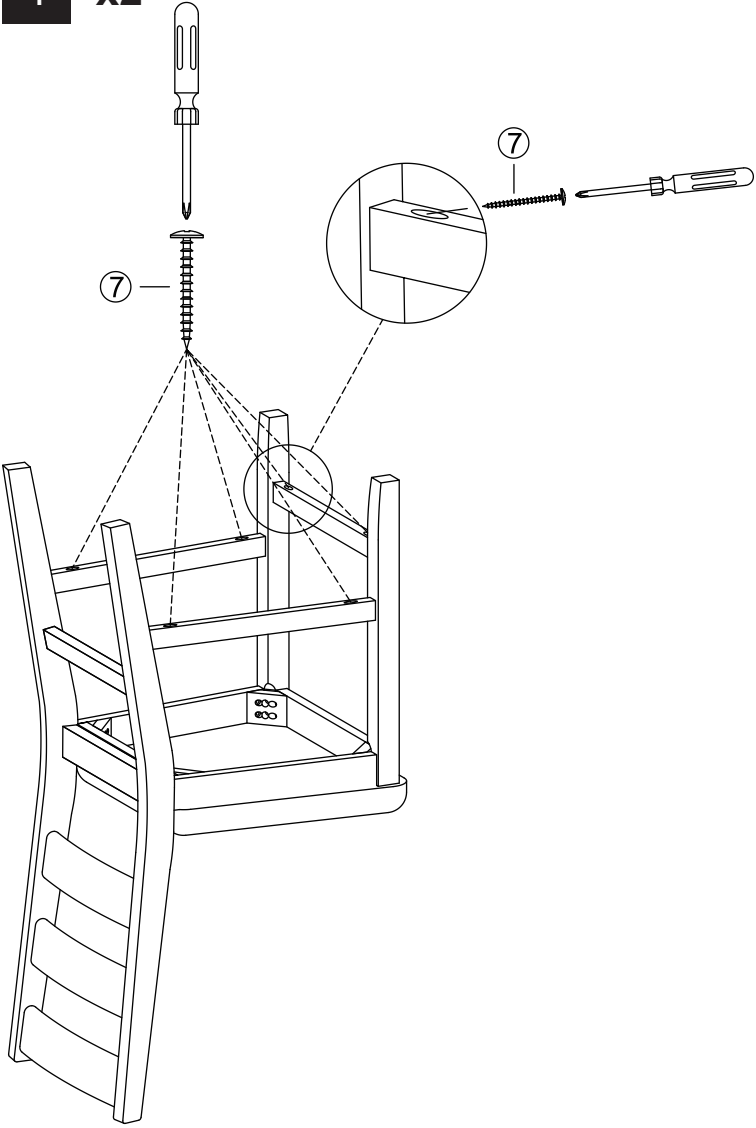

7		x6
---	---	----

**COMPLETE  
/TERMINÉ**

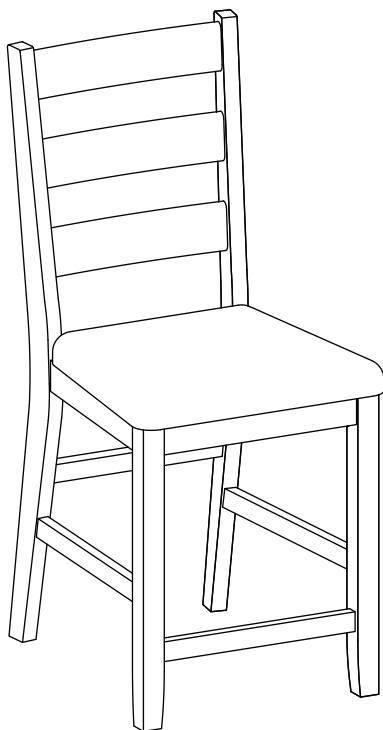
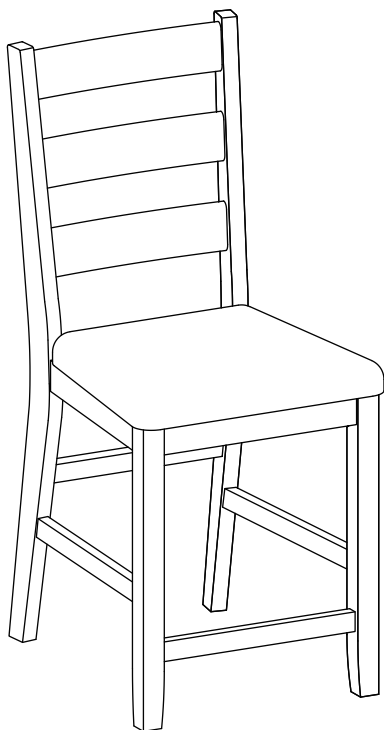

EN



## Return / Damage Claim Instructions

- ⚠ **DO NOT discard the box / original packaging.**  
In case a return is required, the item must be returned in original box. Without this your return will not be accepted.
- ⚠ **Take a photo of the box markings.**  
A photo of the markings (text) on the side of the box is required in case a part is needed for replacement. This helps our staff identify your product number to ensure you receive the correct parts.
- ⚠ **Take a photo of the damaged part (if applicable).**  
A photo of the damage is always required to file a claim and get your replacement or refund processed quickly. Please make sure you have the box even if it is damaged.
- ⚠ **Send us an email with the images requested.**  
Email us directly from marketplace where your item was purchased with the attached images and a description of your claim.

FR



## Instructions De Retour / Réclamation De Dommages

- ⚠ **NE PAS jeter la boîte/l'emballage d'origine.**  
Dans le cas où un retour est requis, l'article doit être retourné dans sa boîte d'origine. Sans cela, votre retour ne sera pas accepté.
- ⚠ **Prenez une photo des marquages de la boîte.**  
Une photo des marquages (texte) sur le côté de la boîte est requise au cas où une pièce serait nécessaire pour le remplacement. Cela aide notre personnel à identifier votre numéro de produit pour s'assurer que vous recevez les bonnes pièces.
- ⚠ **Prenez une photo des dommages (le cas échéant).**  
Une photo des dommages est toujours requise pour déposer une réclamation et obtenir rapidement votre remplacement ou votre remboursement. Assurez-vous d'avoir la boîte même si elle est endommagée.
- ⚠ **Envoyez-nous un e-mail avec les images demandées.**  
Envoyez-nous un e-mail directement depuis le marché où votre article a été acheté avec les images ci-jointes et une description de votre réclamation.

**USA** office: Fontana   **AUS** office: Truganina   **GBR** office: Ipswich   **FRA** office: Saint Vigor d'Ymonville

---

If you're having difficulty, our friendly customer team is always here to help.



USA: [cs.us@costway.com](mailto:cs.us@costway.com)  
AUS: [cs.au@costway.com](mailto:cs.au@costway.com)  
GBR: [cs.uk@costway.com](mailto:cs.uk@costway.com)  
FRA: [cs.fr@costway.com](mailto:cs.fr@costway.com)