

Bookcase with Fabric Drawers
Bücherregal Mit Stoffschubladen
Bibliothèque Avec Tiroirs En Tissu
Librería Con Cajones De Tela
Libreria Con Cassetti In Tessuto
Regał Z Szufladami Z Tkaniny
Boekenkast Met Stoffen Laden

JV12969

USA office: Fontana **ITA** office: Milano **AUS** office: Truganina **POL** office: Gdańsk
DEU office: FDS GmbH, Neuer Höltigbaum 30, 22143 Hamburg, Deutschland
GBR office: FDS Corporation Limited, Unit 4, Blackacre Road, Great Blakenham,
Ipswich, IP6 0FL, United Kingdom **FRA** office: Saint Vigor d'Ymonville

THIS INSTRUCTION BOOKLET CONTAINS **IMPORTANT** SAFETY INFORMATION.
PLEASE READ AND KEEP FOR FUTURE REFERENCE.

EN



Before You Start

- ⚠ Please read all instructions carefully.
- ⚠ Retain instructions for future reference.
- ⚠ Separate and count all parts and hardware.
- ⚠ Read through each step carefully and follow the proper order.
- ⚠ We recommend that, where possible, all items are assembled near to the area in which they will be placed in use, to avoid moving the product unnecessarily once assembled.
- ⚠ Always place the product on a flat, steady and stable surface.
- ⚠ Keep all small parts and packaging materials for this product away from babies and children as they potentially pose a serious choking hazard.

DE



Vor dem Beginnen

- ⚠ Bitte lesen Sie alle Anweisungen sorgfältig durch.
- ⚠ Bewahren Sie die Anweisungen zum zukünftigen Verwendung auf.
- ⚠ Überprüfen Sie, ob alle Teile und Zubehörteile vorhanden sind.
- ⚠ Lesen Sie jeden Schritt sorgfältig durch und befolgen Sie die richtige Reihenfolge.
- ⚠ Wir empfehlen, alle Teile möglichst in der Nähe des Aufstellungsortes zu montieren, um unnötige Bewegungen nach der Montage zu vermeiden.
- ⚠ Stellen Sie den Artikel immer auf eine ebene, feste und stabile Fläche.
- ⚠ Halten Sie alle kleinen Teile und Verpackungsmaterialien fern von Babys und Kindern, ansonsten besteht Erstickengefahr.

FR



Avant de Commencer

- ⚠ Veuillez lire attentivement toutes les instructions.
- ⚠ Conservez les instructions pour vous y référer ultérieurement.
- ⚠ Vérifiez toutes les pièces et les accessoires.
- ⚠ Lisez attentivement chaque étape et suivez l'ordre correct.
- ⚠ Nous recommandons que, dans la mesure du possible, tous les produits soient assemblés à proximité de la zone où ils seront utilisés, afin d'éviter tout déplacement inutile du produit une fois assemblé.
- ⚠ Placez toujours le produit sur une surface plane et stable.
- ⚠ Conservez toutes les petites pièces de ce produit et les matériaux d'emballage hors de portée des bébés et des enfants, car ils pourraient présenter un risque d'étouffement.

ES



Antes de Empezar

- ⚠ Lea atentamente todas las instrucciones.
- ⚠ Conserve las instrucciones para futuras consultas.
- ⚠ Separe y cuente todas las piezas y los accesorios.
- ⚠ Lea detenidamente cada paso y siga el orden correcto.
- ⚠ Recomendamos que, siempre que sea posible, todos los elementos se monten cerca de la zona en la que se van a utilizar, para evitar mover el producto innecesariamente una vez montado.
- ⚠ Coloque siempre el producto sobre una superficie plana, estable y firme.
- ⚠ Mantenga todas las piezas pequeñas y los materiales de embalaje de este producto lejos de los bebés y los niños, ya que pueden representar un grave riesgo de asfixia.

IT



Prima di Iniziare

- ⚠ Si prega di leggere attentamente tutte le istruzioni.
- ⚠ Conservare le istruzioni per riferimento futuro.
- ⚠ Separare e contare tutte le parti e gli accessori.
- ⚠ Leggere attentamente ogni passo e seguire l'ordine corretto.
- ⚠ Si consiglia, ove possibile, di assemblare tutti gli articoli vicino alla zona in cui verranno posti in uso, per evitare di spostare inutilmente il prodotto una volta assemblato.
- ⚠ Posizionare sempre il prodotto su una superficie piana, stabile.
- ⚠ Tenere tutte le piccole parti e i materiali di imballaggio di questo prodotto lontano dalla portata di neonati e bambini, in quanto possono costituire un serio pericolo di soffocamento.

PL



Zanim Zacziesz

- ⚠ Zapoznaj się z instrukcją.
- ⚠ Zachowaj instrukcję do wglądu.
- ⚠ Posortuj części i upewnij się, że zestaw jest kompletny.
- ⚠ Zapoznaj się ze sposobem montażu i postępuj zgodnie z instrukcją.
- ⚠ Zalecamy, aby montaż odbywał się możliwie najbliżej miejsca docelowego położenia produktu, aby uniknąć niepotrzebnego przesuwania.
- ⚠ Upewnij się, że produkt znajdzie się na płaskiej i stabilnej powierzchni.
- ⚠ Upewnij się, że materiały wykorzystane podczas pakowania produktu oraz jego elementy znajdują się poza zasięgiem dzieci.

NL



Voordat U Begint

- ⚠ Lees alstublieft alle instructies zorgvuldig door.
- ⚠ Bewaar de instructies voor toekomstig gebruik.
- ⚠ Scheid en tel alle onderdelen en beslag.
- ⚠ Lees elke stap zorgvuldig door en volg de juiste volgorde.
- ⚠ Wij raden aan om, waar mogelijk, alle items te monteren in de nabijheid van de plaats waar ze zullen worden gebruikt, om onnodige verplaatsing van het product na montage te voorkomen.
- ⚠ Plaats het product altijd op een vlak, stabiel en stevig oppervlak.
- ⚠ Houd alle kleine onderdelen en verpakkingsmaterialen van dit product buiten bereik van baby's en kinderen omdat ze een ernstig verstikkingsgevaar kunnen vormen.

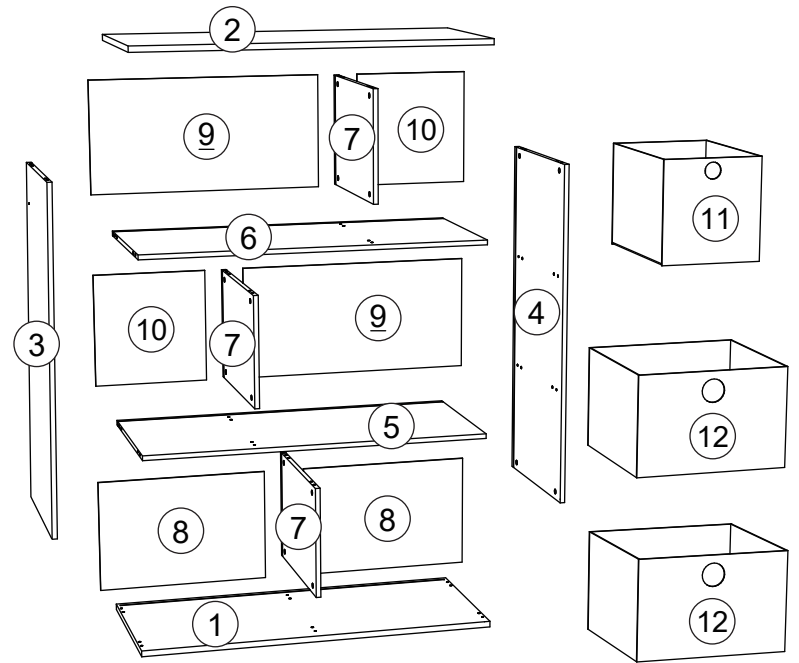
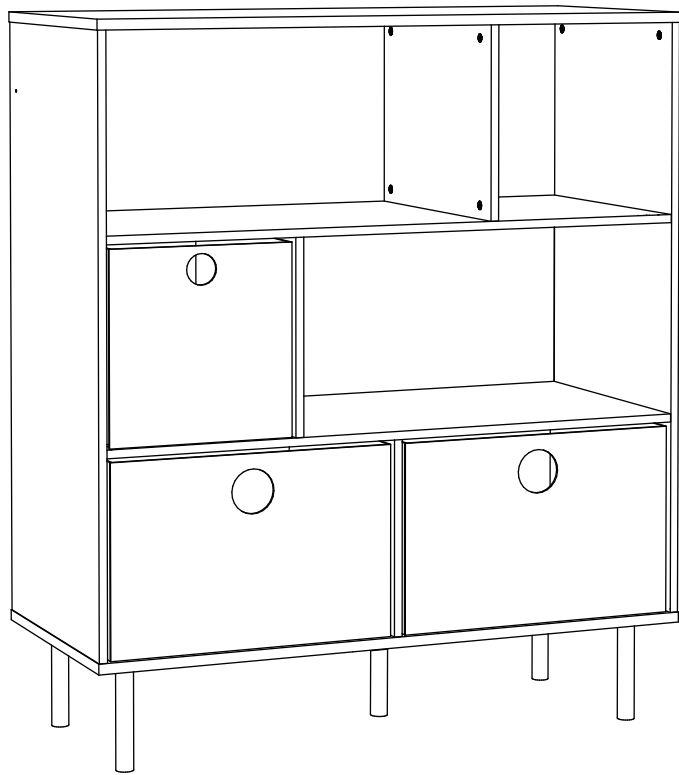

① x1

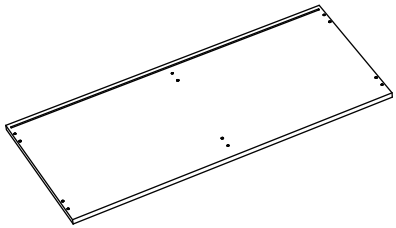

② x1

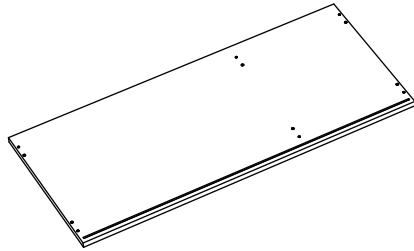

⑦ x3

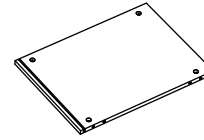

⑧ x2

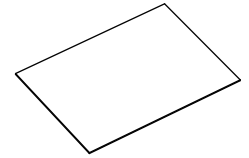

③ x1

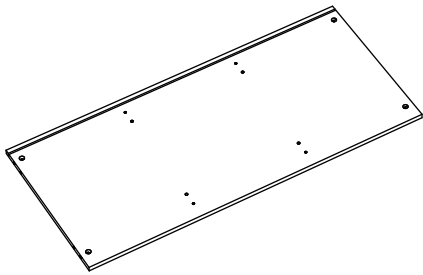

④ x1

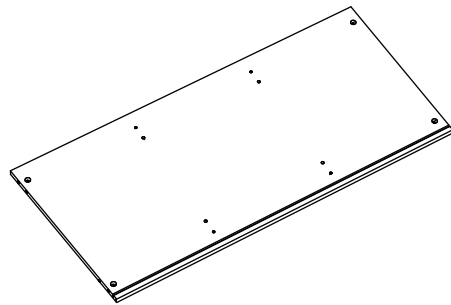

⑨ x2

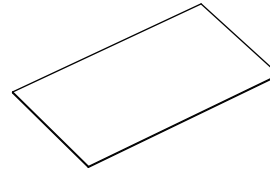

⑩ x2

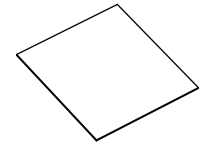

⑤ x1

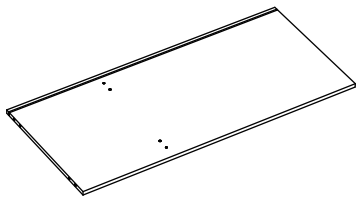

⑥ x1

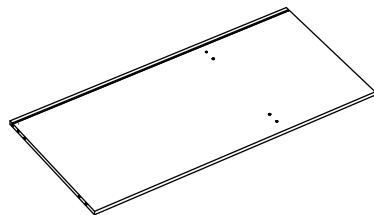

⑪ x1

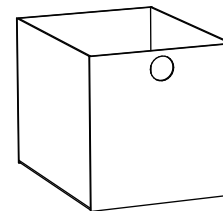

⑫ x2

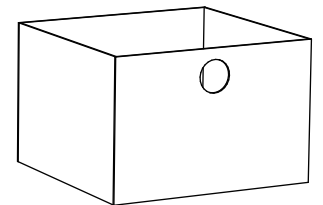

H

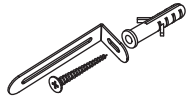

x2

N

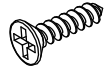

M3.5*12mm

x46

Y

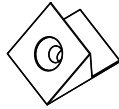

x24

Z



x28

An

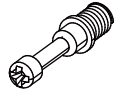

x28

Ao



x28

Bn

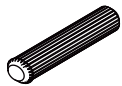

Φ6*30mm

x28

Ce

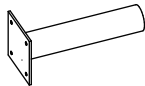

150mm

x5

1

① x1

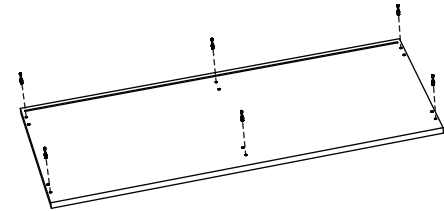

An x6

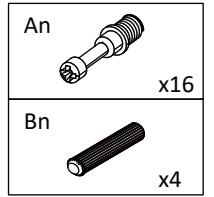

② x1

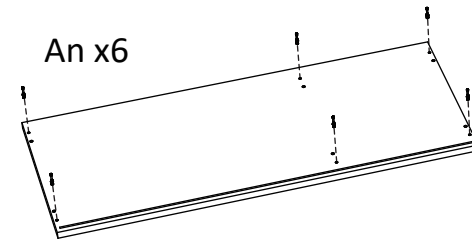

An x6

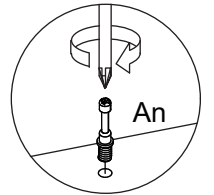

③ x1

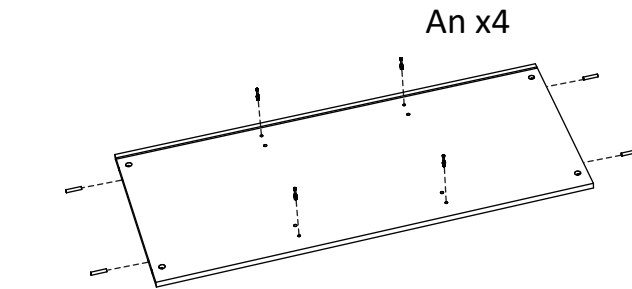

An x4

Bn x4

2

④ x1

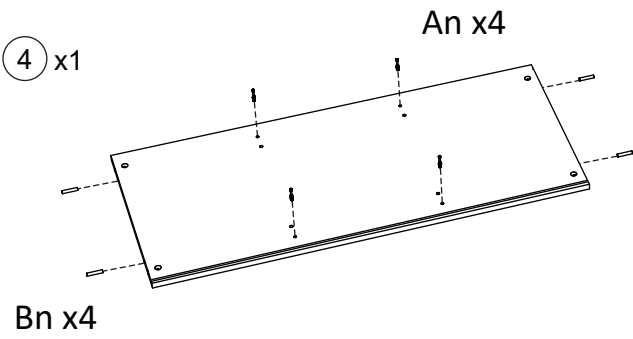

An x4

Bn x4

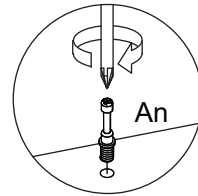
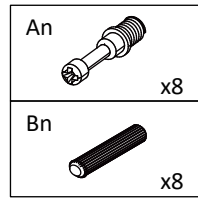

⑤ x1

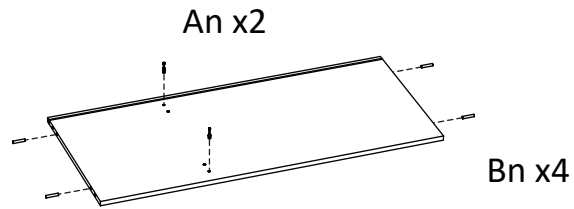

An x2

Bn x4

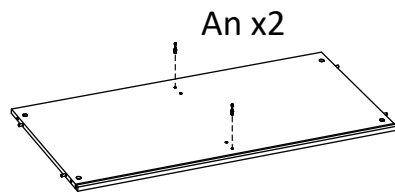

An x2

3

⑥ x1

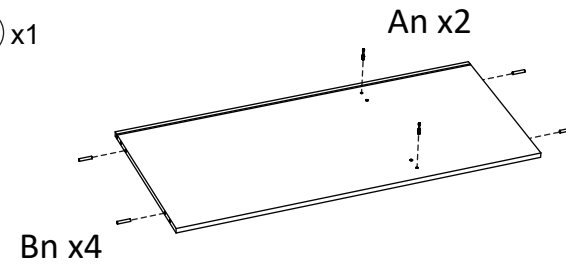

An x2

Bn x4



An x2

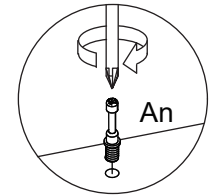
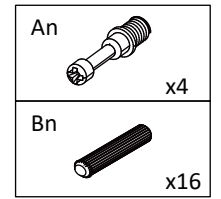
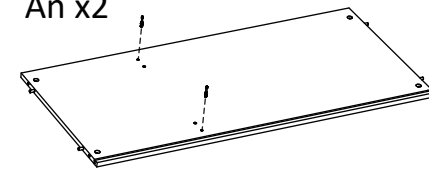

⑦ x3

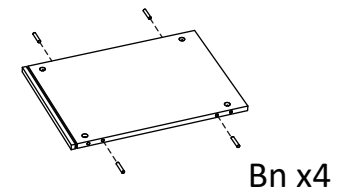

Bn x4

4

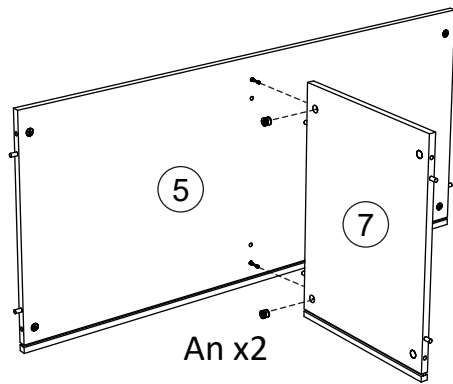

An x2

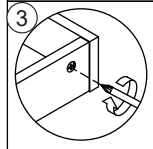
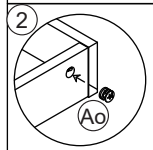
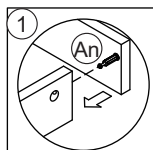
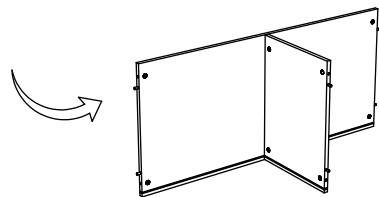

6

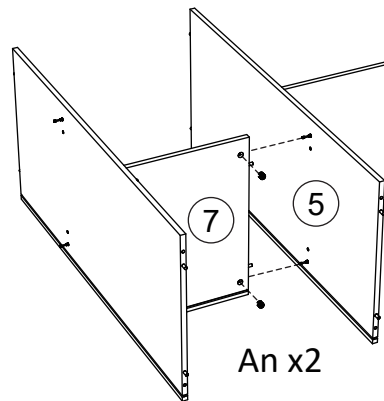

An x2

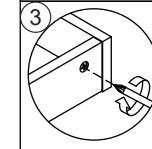
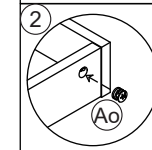
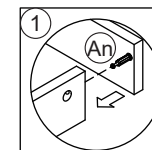
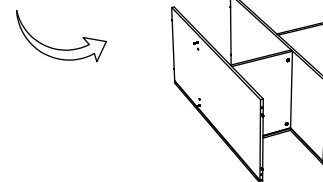

5

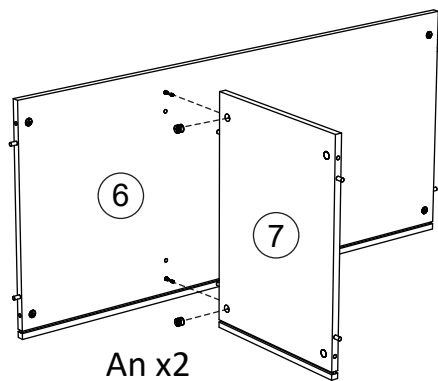

An x2

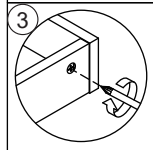
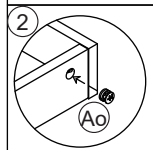
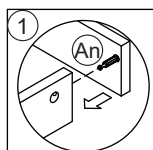
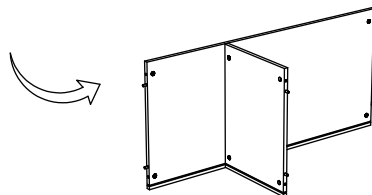

7

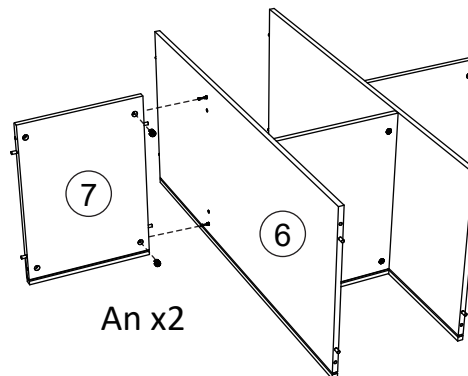

An x2

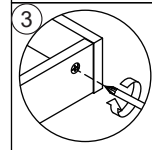
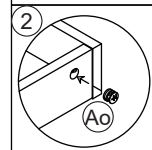
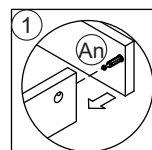
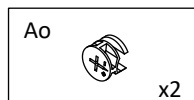
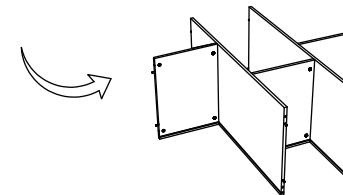

8

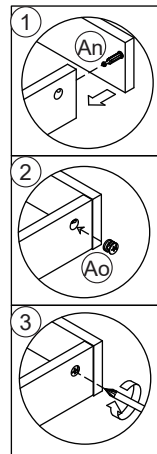
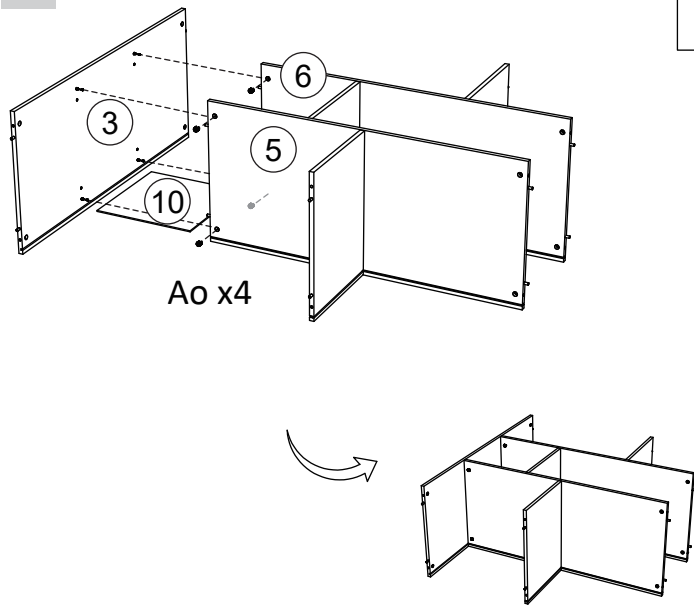

10

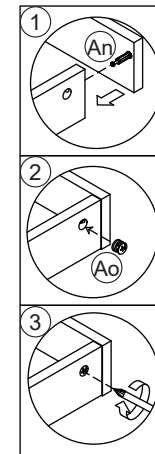
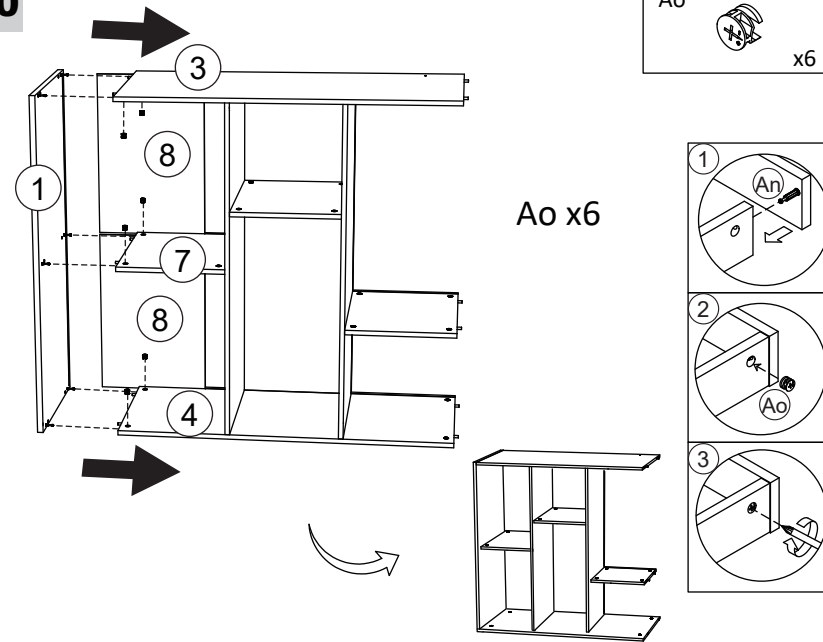

9

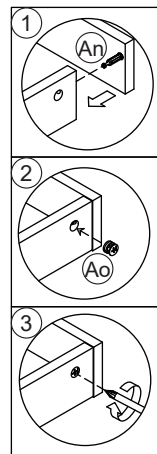
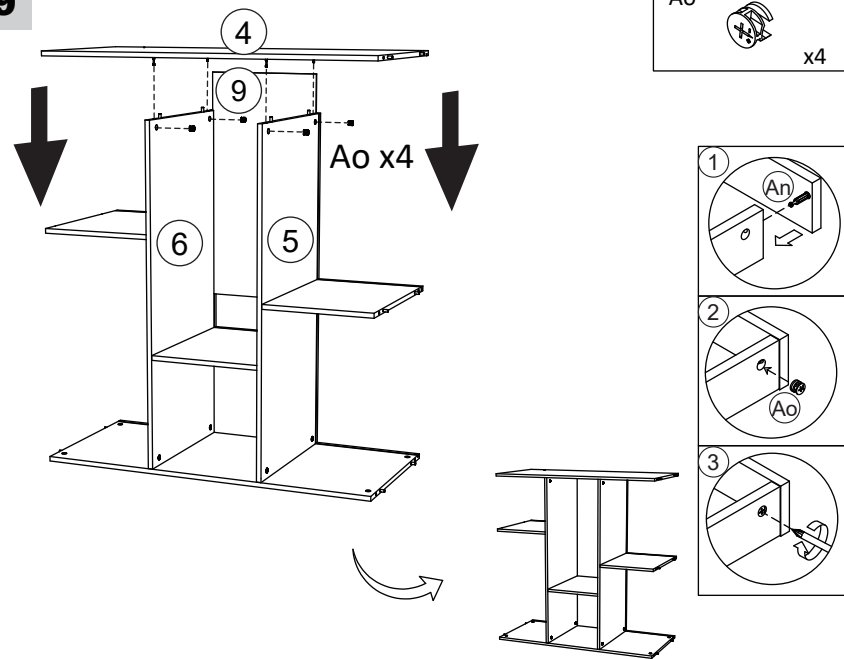

11

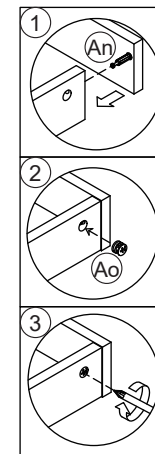
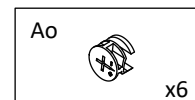
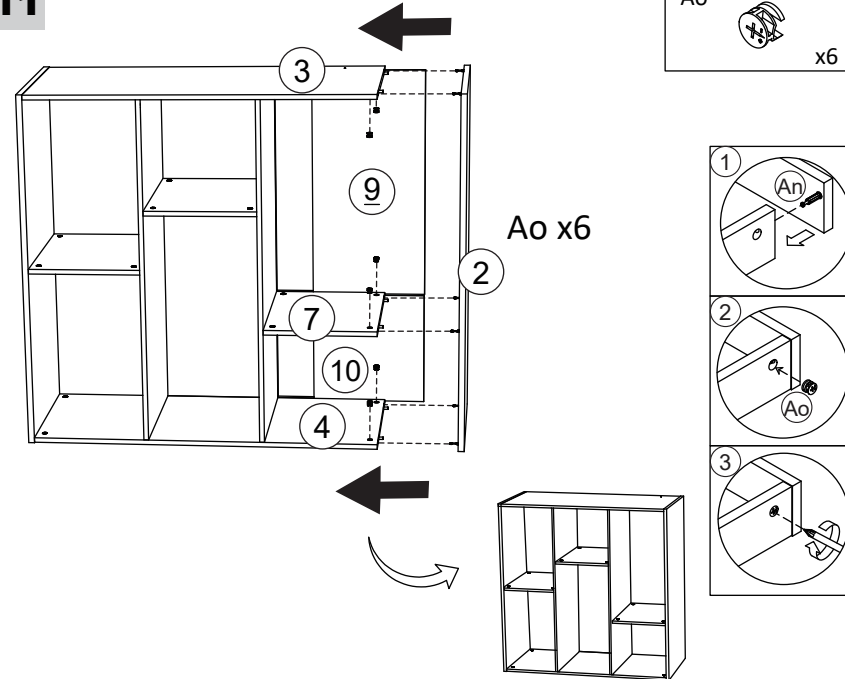

12

N x20
Ce x5

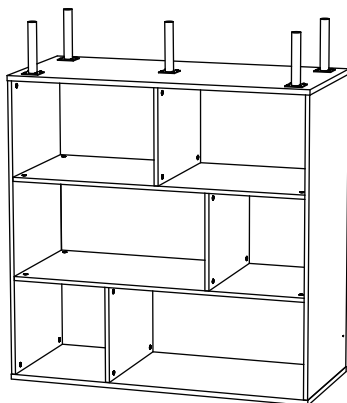
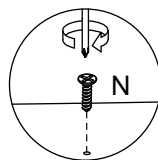
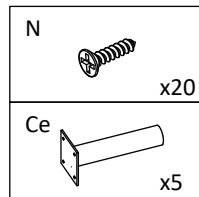
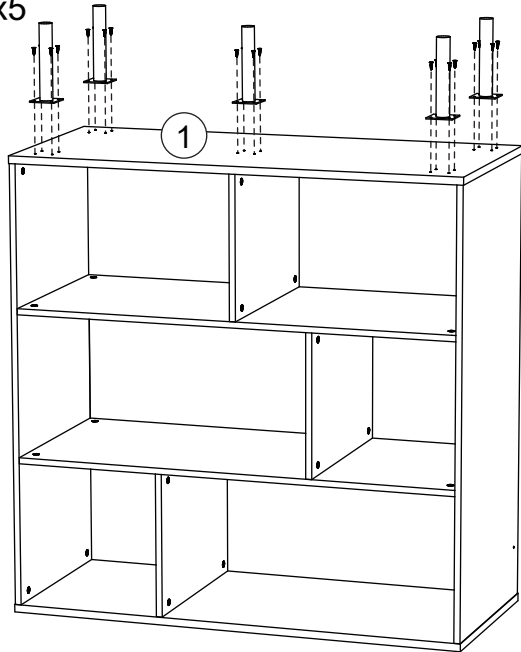

13

N x24
Y x24

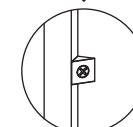
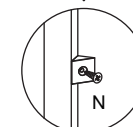
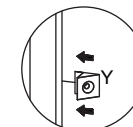
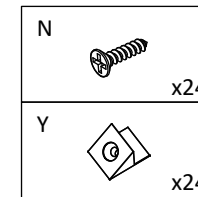
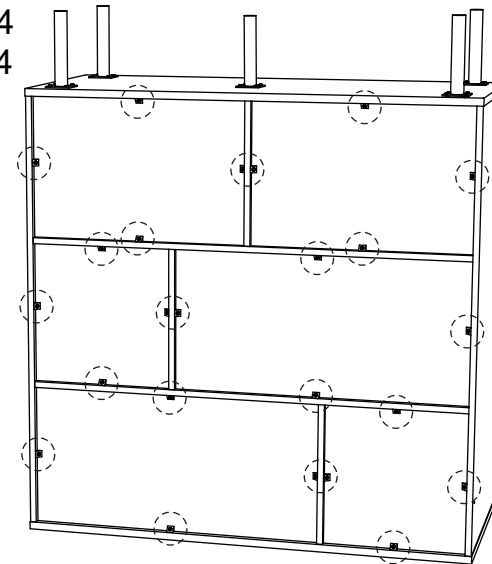

14

Z x28

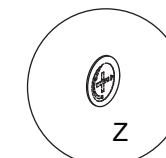
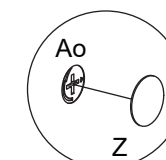
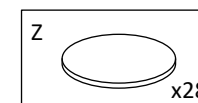
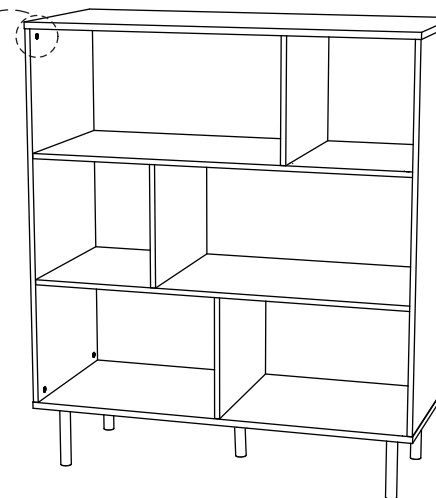

15

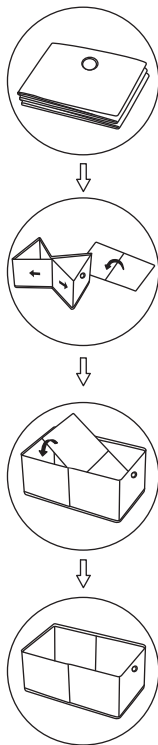
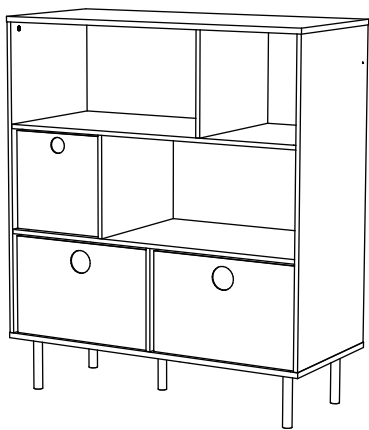
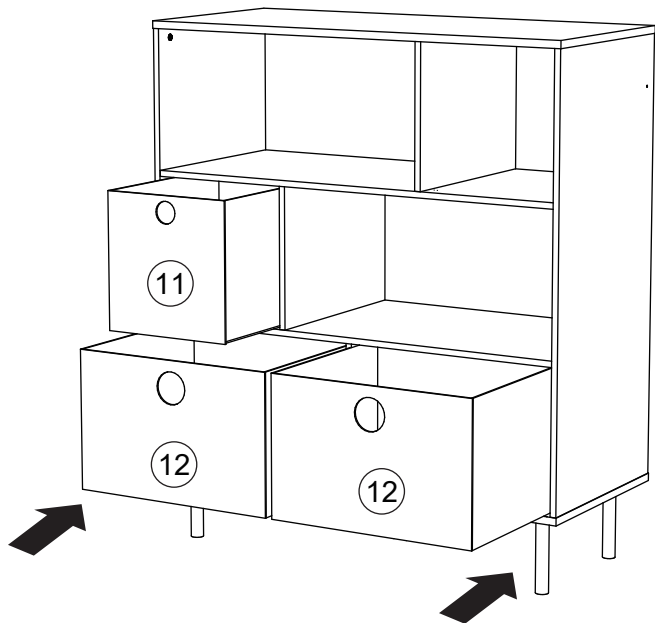

21

