

**USA** office: Fontana

**AUS** office: Truganina

**FRA** office: Saint Vigor d'Ymonville

**GBR** office: FDS Corporation Limited, Unit 4, Blackacre Road, Great Blakenham, Ipswich, Ip6 0FL, United Kingdom

If you're having difficulty, our friendly customer team is always here to help.



USA:cs.us@costway.com  
AUS:cs.au@costway.com  
GBR:cs.uk@costway.com  
FRA:cs.fr@costway.com

Corner Desk  
Bureau d'Angle  
**JV11100GB**

THIS INSTRUCTION BOOKLET CONTAINS **IMPORTANT** SAFETY INFORMATION.  
PLEASE READ AND KEEP FOR FUTURE REFERENCE.

EN



### Before You Start

- ⚠ Please read all instructions carefully.
- ⚠ Retain instructions for future reference.
- ⚠ Separate and count all parts and hardware.
- ⚠ Read through each step carefully and follow the proper order.
- ⚠ We recommend that, where possible, all items are assembled near to the area in which they will be placed in use, to avoid moving the product unnecessarily once assembled.
- ⚠ Always place the product on a flat, steady and stable surface.
- ⚠ Keep all small parts and packaging materials for this product away from babies and children as they potentially pose a serious choking hazard.

FR



### Avant de Commencer

- ⚠ Veuillez lire attentivement toutes les instructions.
- ⚠ Conservez les instructions pour vous y référer ultérieurement.
- ⚠ Vérifiez toutes les pièces et les accessoires.
- ⚠ Lisez attentivement chaque étape et suivez l'ordre correct.
- ⚠ Nous recommandons que, dans la mesure du possible, tous les produits soient assemblés à proximité de la zone où ils seront utilisés, afin d'éviter tout déplacement inutile du produit une fois assemblé.
- ⚠ Placez toujours le produit sur une surface plane et stable.
- ⚠ Conservez toutes les petites pièces de ce produit et les matériaux d'emballage hors de portée des bébés et des enfants, car ils pourraient présenter un risque d'étouffement.

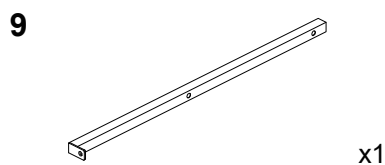
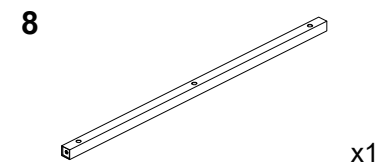
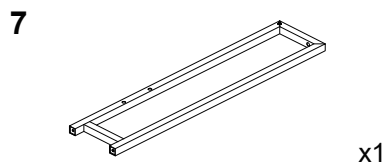
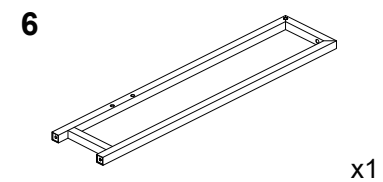
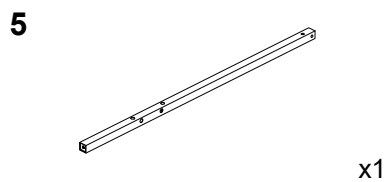
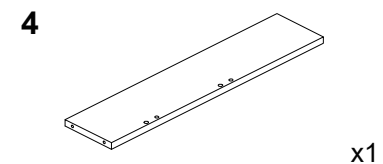
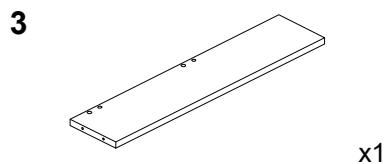
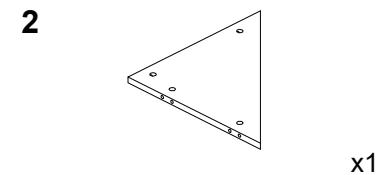
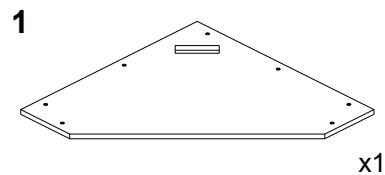

(A) x4

(B) x4

(C) x4

(E) x2



8\*40mm

M3.5\*14mm

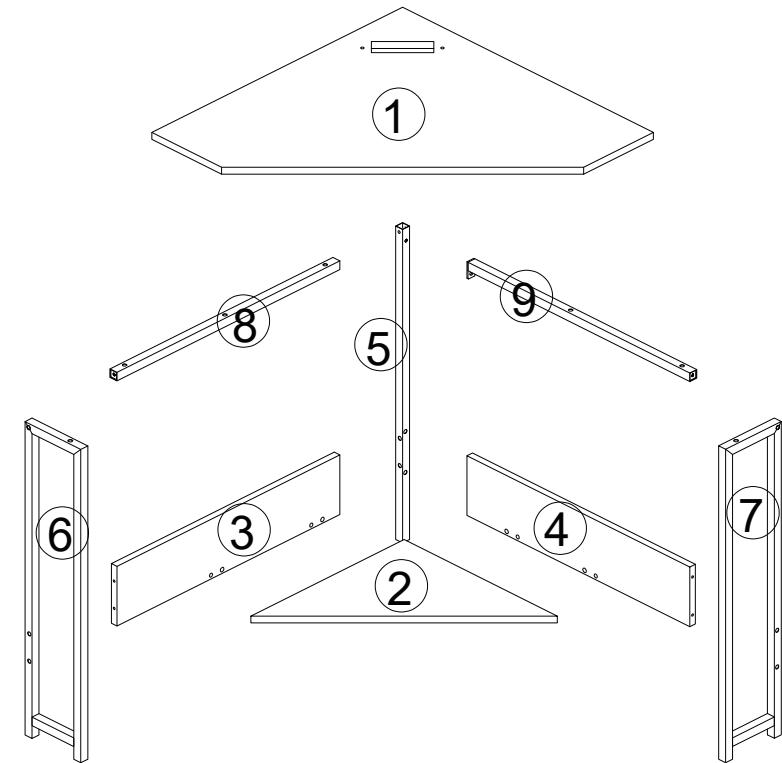
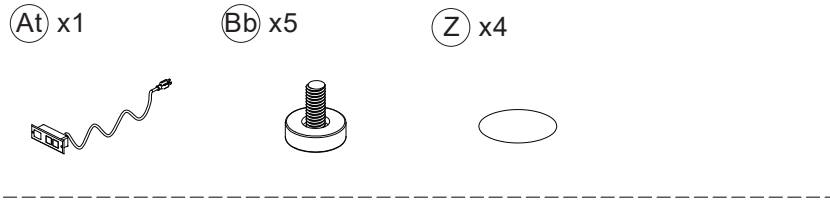
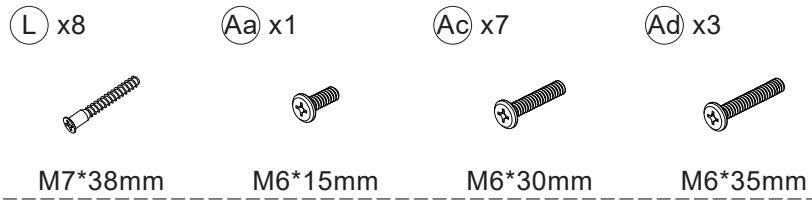





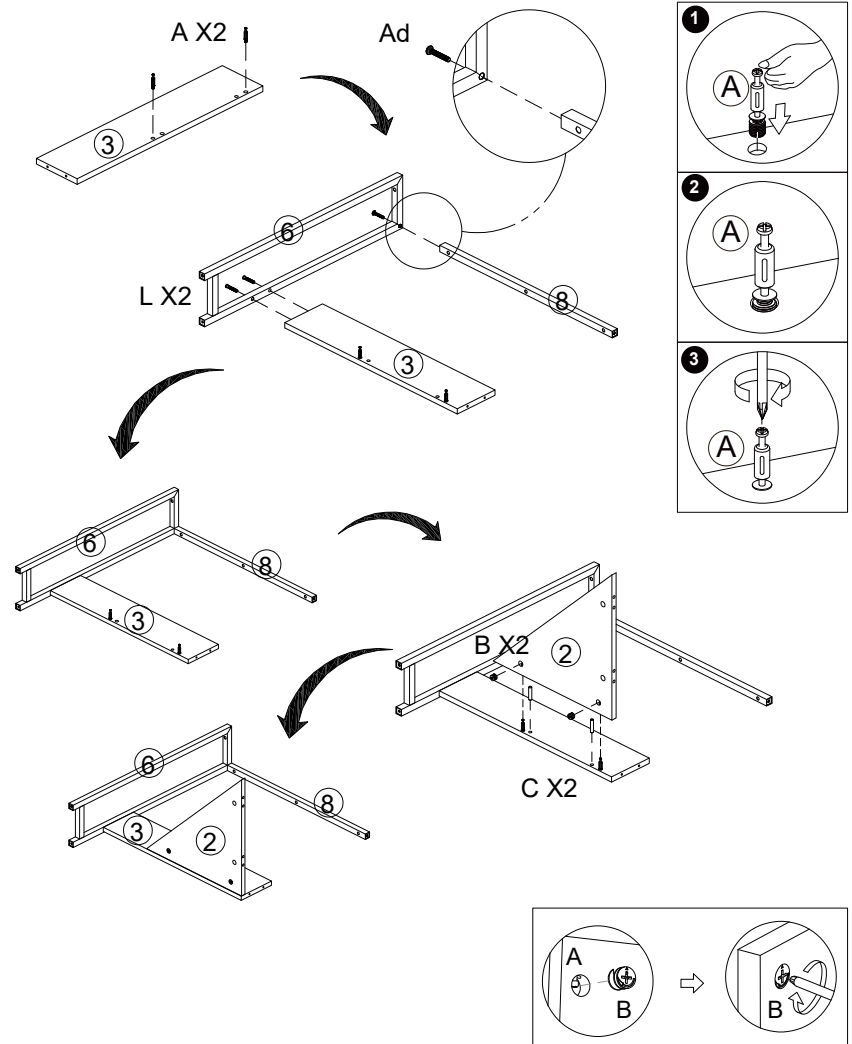

**1**





	A X2	B X2
C X2	L X2	Ad X1

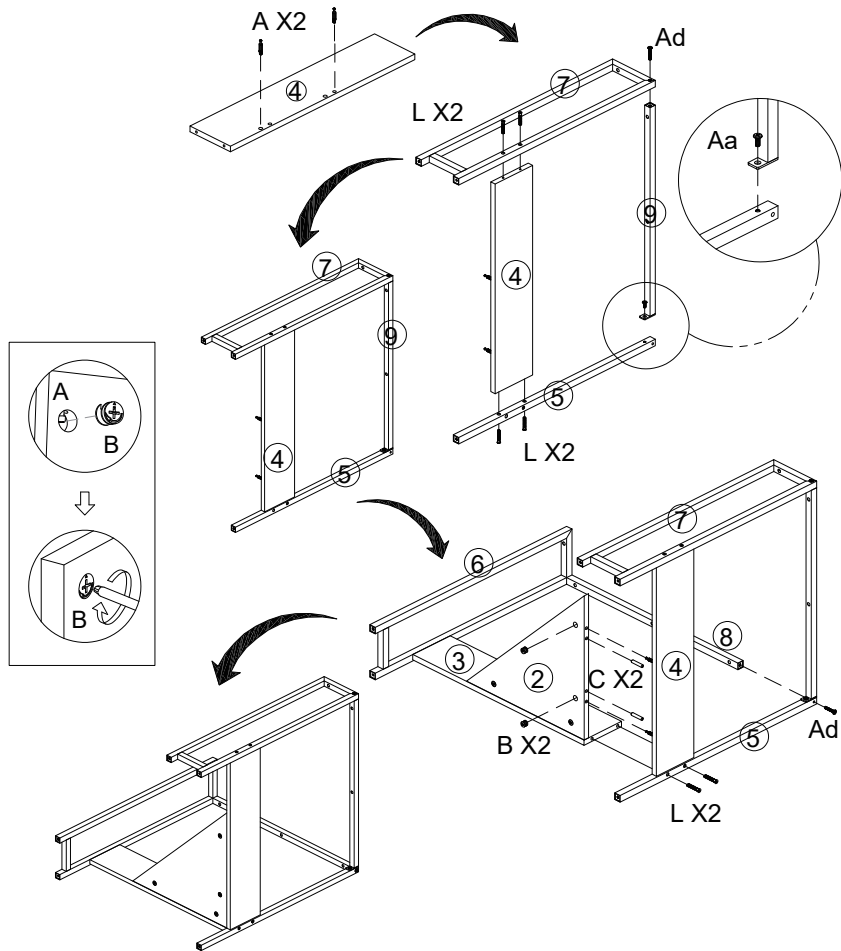

**2**

A  X2	B  X2	C  X2
L  X6	Aa  X1	Ad  X2

**3**

E  X2	Ac  X7	At  X1
Bb  X5	Z  X4	

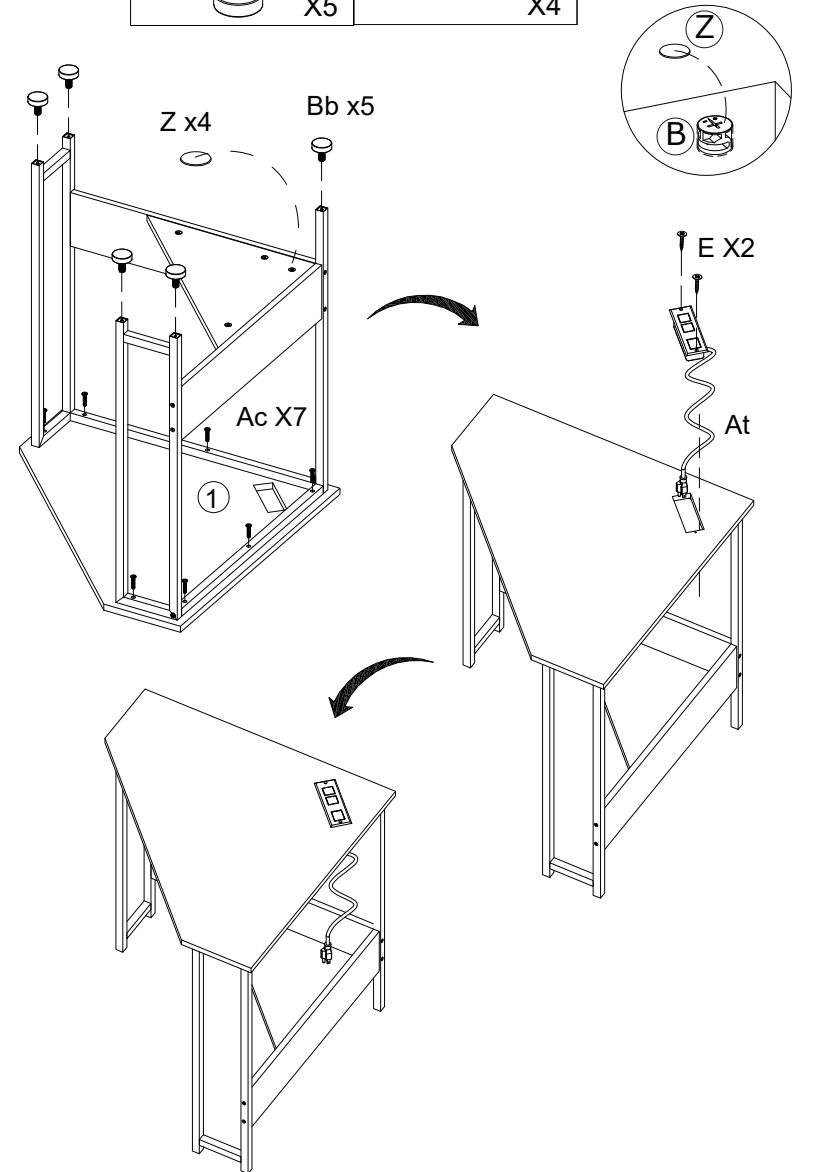

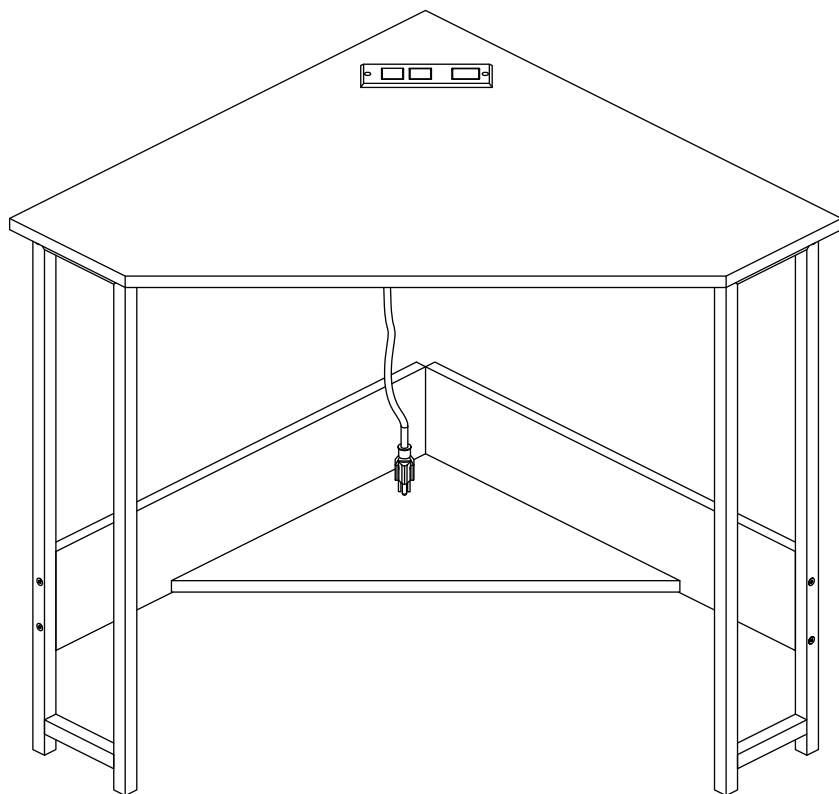

EN



### Return / Damage Claim Instructions

- ⚠ DO NOT discard the box / original packaging.**  
In case a return is required, the item must be returned in original box. Without this your return will not be accepted.
- ⚠ Take a photo of the box markings.**  
A photo of the markings (text) on the side of the box is required in case a part is needed for replacement. This helps our staff identify your product number to ensure you receive the correct parts.
- ⚠ Take a photo of the damaged part (if applicable).**  
A photo of the damage is always required to file a claim and get your replacement or refund processed quickly. Please make sure you have the box even if it is damaged.
- ⚠ Send us an email with the images requested.**  
Email us directly from marketplace where your item was purchased with the attached images and a description of your claim.

FR



### Instructions De Retour / Réclamation De Dommages

- ⚠ NE PAS jeter la boîte/l'emballage d'origine.**  
Dans le cas où un retour est requis, l'article doit être retourné dans sa boîte d'origine. Sans cela, votre retour ne sera pas accepté.
- ⚠ Prenez une photo des marquages de la boîte.**  
Une photo des marquages (texte) sur le côté de la boîte est requise au cas où une pièce serait nécessaire pour le remplacement. Cela aide notre personnel à identifier votre numéro de produit pour s'assurer que vous recevez les bonnes pièces.
- ⚠ Prenez une photo des dommages (le cas échéant).**  
Une photo des dommages est toujours requise pour déposer une réclamation et obtenir rapidement votre remplacement ou votre remboursement. Assurez-vous d'avoir la boîte même si elle est endommagée.
- ⚠ Envoyez-nous un e-mail avec les images demandées.**  
Envoyez-nous un e-mail directement depuis le marché où votre article a été acheté avec les images ci-jointes et une description de votre réclamation.