

USA office: Fontana

AUS office: Truganina

FRA office: Saint Vigor d'Ymonville

GBR office: FDS Corporation Limited, Unit 4, Blackacre Road, Great Blakenham, Ipswich, Ip6 0FL, United Kingdom

Electric Fireplace  
Foyer Électrique  
**FP10802GB**

THIS INSTRUCTION BOOKLET CONTAINS **IMPORTANT** SAFETY INFORMATION.  
PLEASE READ AND KEEP FOR FUTURE REFERENCE.

EN



## Before You Start

- ⚠ Please read all instructions carefully.
- ⚠ Retain instructions for future reference.
- ⚠ Separate and count all parts and hardware.
- ⚠ Read through each step carefully and follow the proper order.
- ⚠ We recommend that, where possible, all items are assembled near to the area in which they will be placed in use, to avoid moving the product unnecessarily once assembled.
- ⚠ Always place the product on a flat, steady and stable surface.
- ⚠ Keep all small parts and packaging materials for this product away from babies and children as they potentially pose a serious choking hazard.

FR



## Avant de Commencer

- ⚠ Veuillez lire attentivement toutes les instructions.
- ⚠ Conservez les instructions pour vous y référer ultérieurement.
- ⚠ Vérifiez toutes les pièces et les accessoires.
- ⚠ Lisez attentivement chaque étape et suivez l'ordre correct.
- ⚠ Nous recommandons que, dans la mesure du possible, tous les produits soient assemblés à proximité de la zone où ils seront utilisés, afin d'éviter tout déplacement inutile du produit une fois assemblé.
- ⚠ Placez toujours le produit sur une surface plane et stable.
- ⚠ Conservez toutes les petites pièces de ce produit et les matériaux d'emballage hors de portée des bébés et des enfants, car ils pourraient présenter un risque d'étouffement.





## CONSUMER SAFETY INFORMATION

- Read this manual before installing and operating this appliance
- Failure to follow these instructions may result in electric shock, fire property, or personal injury
- Do not store or use gasoline or other flammable liquids in vicinity of this appliance.

## IMPORTANT SAFETY INFORMATION!



## WARNING



- **Read all instructions before using this heater!**
- This heater is hot **when in use**. To avoid burns, **DO NOT** let bare skin touch hot surfaces. If provided, use handles when moving this heater. Keep **combustible materials**, such as furniture, pillows, bedding, papers, clothes, and curtains at least 3 feet (0.9m) from the front of the heater, and keep them away from the sides and rear.
- Extreme caution is necessary when any heater is used by or near children or invalids and whenever the heater is left operating and unattended.
- **DO NOT** operate any heater with a damaged cord or plug or after the heater malfunctions, has been dropped or damaged in any manner, Discard heater, or return to authorized service facility for examination and /or repair.
- **DO NOT** run power cord under carpeting. **DO NOT** cover power cord with throw rugs, runners, or similar coverings. **DO NOT** route power cord under furniture or appliances. Arrange power cord away from traffic area, and where it will not be tripped over.



## WARNING



- Connect to properly grounded outlets **ONLY**.
- **DO NOT** insert or allow foreign objects to enter any ventilation or exhaust openings, as this may cause electric shock or fire, or damage the heater.
- To prevent a possible fire, **DO NOT** block air intakes or exhaust in any manner. Doing so could cause a fire. **DO NOT** use on soft surfaces, like a bed, where openings may become blocked.
- A heater has hot and arcing or sparking parts inside. **DO NOT** use it in areas where gasoline, paint, or flammable liquids are used or stored.
- Use this heater only as described in this manual. Any other use not recommended by the manufacturer may cause fire, electric shock, or injury to persons.
- **ALWAYS** plug heaters directly into a wall outlet/receptacle. Never use with an extension cord or relocatable power tap (outlet/power strip).
- **DO NOT** place the heater near a bed because objects such as pillows or blankets can fall off the bed and be ignited by the heater.
- **NEVER** use this heater in bathrooms, laundry rooms, or any other location where the heater could fall into a bathtub or pool, become damp or come in contact with water.
- **AVOID FIRE!** Regularly inspect all air vents to make sure they are free from dust, lint, or other Blockage. Unplug the unit and clean with a vacuum **ONLY**. **DO NOT** rinse or get wet.
- **ALWAYS** mount to wall bracket before use. **DO NOT** set on the floor, or other surface, to use.
- **NEVER** use a wall mount bracket from another manufacturer.
- This product is not intended to be a primary heat source. It is for supplemental heat only.
- **INDOOR** use only! **NEVER** use this heater outdoors! Doing so may result in electric shock!



## WARNING



- Risk of electric shock! DO NOT OPEN! No user-serviceable parts inside!
- ALWAYS turn this heater off before unplugging it from the outlet.
- ALWAYS disconnect this unit from the power supply before performing any assembly or cleaning, or before relocating the electric fireplace.
- NEVER leave this heater unattended. ALWAYS unplug this heater when not in use.
- ALWAYS store this heater in a dry location. NEVER use the fireplace if it has become wet.
- NEVER plug this heater into an outlet that is old, cracked, or has any loose wires or connections. Plugging this heater into a faulty outlet could result in electric arcing within the outlet that could cause the outlet to overheat or catch fire.
- ALWAYS check your heater cord and plug connections with each use!
  - i) MAKE SURE the plug fits tight in the outlet! Faulty wall outlet connections or loose plugs can cause the outlet to overheat.
  - ii) Heaters draw more current than small appliances. Overheating may occur even if it has not occurred with the use of other appliances.
  - iii) During use check frequently to see if the plug outlet or face plate is HOT!
  - iv) If the outlet or face plate is HOT, discontinue use immediately and have a qualified electrician inspect and/or replace the faulty outlets.



## WARNING



- The power cord supplied with the heater has a plug with two flat blades (live and neutral) and one round pin (ground). If a 3-slot receptacle is not available, an adapter MUST be used. The adapter MUST be properly grounded to the outlet box (see figure at right).(Note: Adapter NOT INCLUDED.)
- This product belong to CLASS I electric appliance, MUST use reliable grounding. Do not change the power cord to avoid accidents. After use, please unplug the power cord.
- This product belong to CLASS I electric appliance, MUST use reliable grounding. Do not change the power cord to avoid accidents. After use, please unplug the power cord
- **SAVE THESE INSTRUCTIONS!**

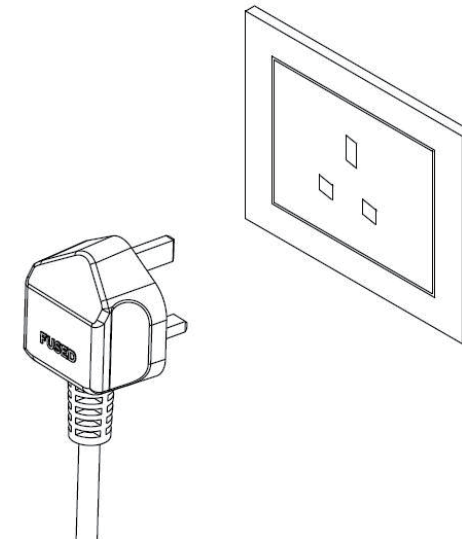

## PREPARATION



This product includes a GLASS panel! Always use extreme caution when handling glass. Failure to do so could result in personal injury or property damage.

Remove all parts and hardware from the carton and place them on a clean, soft, dry surface. Parts and assembly steps are grounded for wall-hanging or recessing use. Check the parts list to make sure nothing is missing. Dispose of packaging materials properly. Please recycle whenever possible. You will need the following tools (not included): Phillips screwdriver; stud finder; level; tape measure; electric drill; 1/4" wood drill bit, hammer.

## PARTS & HARDWARE



(A) x1

Fireplace



(B) x12

4x12mm Screws

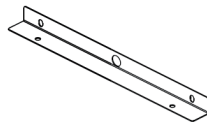

(C) x3

Metal bracket

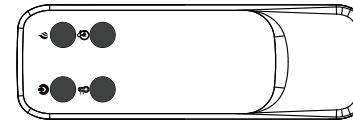

Remotecontrol

(D) x1

## WARNING



**Read and understand this entire owner's manual, including all safety information, before plugging in or using this product. Failure to do so could result in electric shock, fire, serious injury, or death.**

### Power

Plug the power cord into a 220V-240V Volt 7.5 Amp grounded outlet (see IMPORTANT SAFETY INFORMATION). Make sure the outlet is in good condition and that the plug is not loose. NEVER exceed the maximum amperage for the circuit. DO NOT plug other appliances into the same circuit.

## Methods of Operation

This electric fireplace can be operated by the MANUAL PANEL, located on the TOP right side metal panel of the fireplace, or by the battery-powered REMOTE CONTROL.

The operation and functions of the two methods are the same.

Before operating, please review the IMPORTANT SAFETY INFORMATION and heed all warnings.

power supply	220V-240V/50Hz
Rate power	1500W

## TOOLS REQUIRED



PHILLIPS  
SCREWDRIVER



DRILL & NO. 6 DRILL BIT



PENCIL & RULER





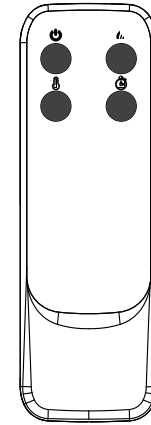

2 AAA BATTERIES

## Control panel and Remote control



## Manual panel/Remote control Operation

BUTTON	FUNCTION	ACTION&INDICATION
	<ol style="list-style-type: none"> <li>1 . Press once to turn on flame effect, fuel bed lights, and enable remote control functions</li> <li>2 . Press again to turn off fame effect, and shut off power to remote control, and all functions</li> </ol>	<ol style="list-style-type: none"> <li>1 . Flame effect and fuel bed turn on. Remote control functions are enabled</li> <li>2 . Flame effect turn off. The remote control functions will not function.</li> </ol>
	COLOR button: Makes the color flame effect changing.	<ol style="list-style-type: none"> <li>1 . Press once. Flame color effect get changing. Press again until desired setting is reached.</li> </ol> <p>Keep press 3 seconds Makes flame effect dimmer and brighter. Press again until desired setting is reached.</p>

BUTTON	FUNCTION	ACTION&INDICATION
	HEATER button: Turn heater on and off	<p>1 . Press once. Indicator lights up, shows " 00 " no heater</p> <p>2 . Press again. Indicator lights up, shows "HH" 1500 W heaters turns on and blows hot air.</p> <p>3 . Press again, set the temperature 18 C - 28 C -00-HH</p>
	TIMER button: control timer settings to turn off fireplace at selected time.	<p>Press once. Indicator light turn on.</p> <p>Temperature is set to hours.</p> <p>Press again until desired setting is reached. LED display show setting</p>

<b>NOTICE</b>	To improve operation, DO NOT press the buttons too quickly. Give the unit time to respond to each command.
---------------	--

 <b>WARNING!</b>	NEVER leave heater unattended during operation! Failure to do so could result in personal injury or property damage.
---	--

<b>NOTICE</b>	When the heater is first turned on, a slight odor may be present. This is normal and should not occur again unless heater is not used for a long period of time.
---------------	--

## Remote Control Battery Information

- Small remote control uses two AA batteries (not included)

	<b>NEVER</b> dispose of batteries in fire. Failure to observe this precaution may result in an explosion.
---	---

## CARE AND MAINTENANCE

	<b>ALWAYS</b> turn the heater OFF and unplug the power cord from the outlet before cleaning performing maintenance, or moving this fireplace. Failure to do so could result in electric shock ,fire, or personal injury.
---	--

## Cleaning

	<b>NEVER</b> immerse in water or spray with water. Doing so could result in electric shock, fire, or personal injury.
---	---

- Using a soft cloth, slightly dampened with a citrus oil-based product
- DO NOT use brass polish or household cleaners as these products will damage the metal trim
- Use a good quality glass cleaner and dry thoroughly with a paper towel or lint-free cloth
- NEVER use abrasive cleansers, liquid sprays, or any cleaner that could scratch the surface vents
- Use a vacuum or duster to remove dust and dirt from the heater and vent areas.
- Clean the exterior of the fireplace with a slightly damp cloth or duster

## Maintenance



Risk of electric shock! DO NOT OPEN!



ALWAYS turn the heater OFF and unplug the power cord from the outlet before cleaning performing maintenance, or moving this fireplace. Failure to do so could result in electric shock, fire, or personal injury.

## Electrical and Moving parts

- The fan motors are lubricated at the factory and will not require lubrication
- Electrical components are integrated in the fireplace and are not serviceable by the consumer

### storage:

- Store heater in a clean dry place when not in use



WARNING! No servicing should be performed by the consumer. DO NOT ATTEMPT TO service the unit by yourself

## INSTALLATION AND ASSEMBLY

- 1 . Select a suitable location that is not susceptible to moisture.
- 2 . Fix part A,B , C On the fireplace by 2 screws. (Fig A)
- 3 Fix the fireplace in the fireplace mantel by screws

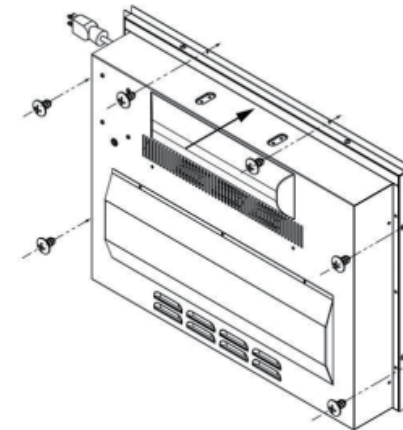
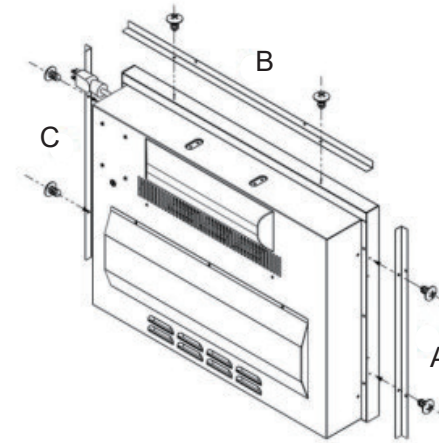

## TROUBLESHOOTING



**WARNING:** Turn off the appliance, unplug and let cool for at least 10 minutes before attempting to service. Only a qualified professional should attempt to service or repair the appliance.

Problem	Possible Cause	Solution
1. Fireplace turns off and will not turn on.	1. Fireplace has overheated and safety device has caused thermal switch to disconnect or home circuit breaker has opened.	1. Reset switch by turning main power off and waiting turning it back on or breaker circuit breaker.
2. Flame is not moving.	1. Loose wiring. 2. Flame motor defective. 3. Flame rod out of place	1. Inspect wiring for loose connections. 2. Call a qualified service technician to replace flame motor. 3. "Flame Rod" out of place due to rough transit/handing of the product. This issue can be corrected as simple as removing the glass, flipping the fireplace upside and down, removing a set of screws that are holding the bottom frame plate and placing the flame rod back into place.

Problem	Possible Cause	Solution
3 Flame is not visible.	1. Wiring is loose	1. Disconnect from power source and inspect wiring for loose connections and repair or replace if necessary. 2. Push the flame button to high
4 Log set and /or is not glowing.	1. Wiring is loose 2. Ember is off mode	1. Disconnect from power source and inspect wiring for loose connections and repair or replace if necessary.
5 Remote control does not work.	1. Low batteries. 2. Not aiming control correctly. 3. Defective remote control and /or sensor	1. Replace batteries in remote control. 2. Aim control at sensor located directly behind glass screen in center of unit just above logs. 3. Replace remote control and/or sensor.