

Assembly Instructions

Hallie Lamp Table

519641-01-01

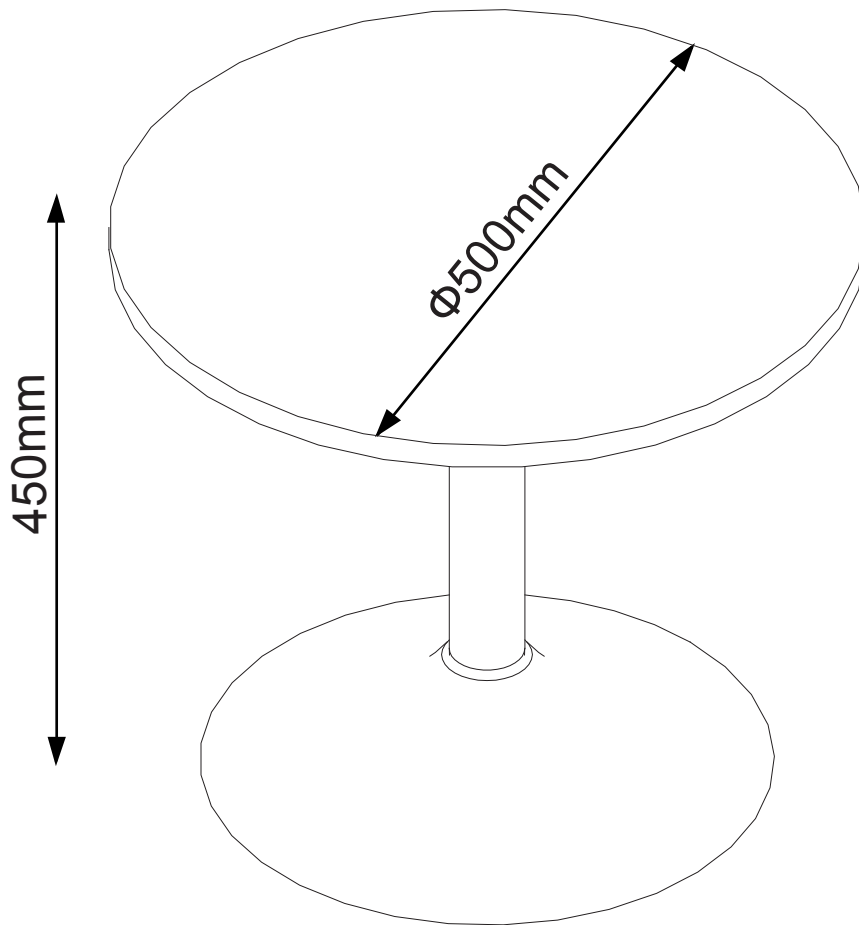

Keep these instructions for future reference

Assemble the furniture on a soft level surface to avoid damaging the furniture or your floor.

We recommend furniture be assembled near where they will be placed, to avoid moving the product unnecessarily once assembled.

If there is a need to move the furniture, please remove all loose items and have extra hands to help lift the furniture to the desired location. Dragging the furniture will damage both the furniture and the floor.

Regularly check and re-tighten(if necessary) all bolts on furniture that you have assembled yourself.







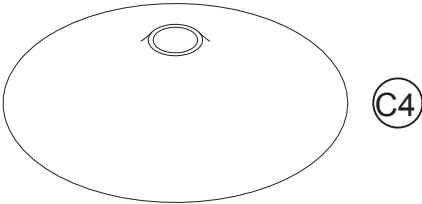
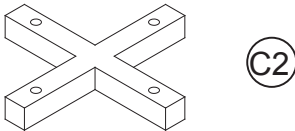
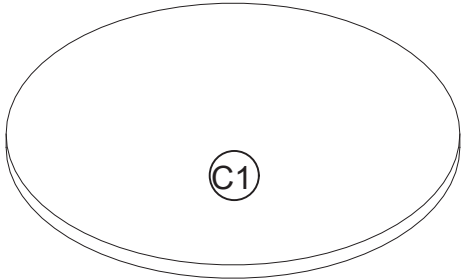

Prevent pets from climbing, scratching or clawing the furniture.

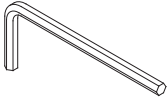
Prevent children from climbing and jumping on furniture.

PARTS LIST



HARDWARE LIST

<p>Ax1</p> 	<p>Bx1</p> 	<p>Cx1</p> 	<p>Dx1</p> 
<p>Ex1</p> 	<p>Fx1</p> 	<p>Gx4</p> 	<p>Hx4</p> 
<p>Jx8</p> 			

1

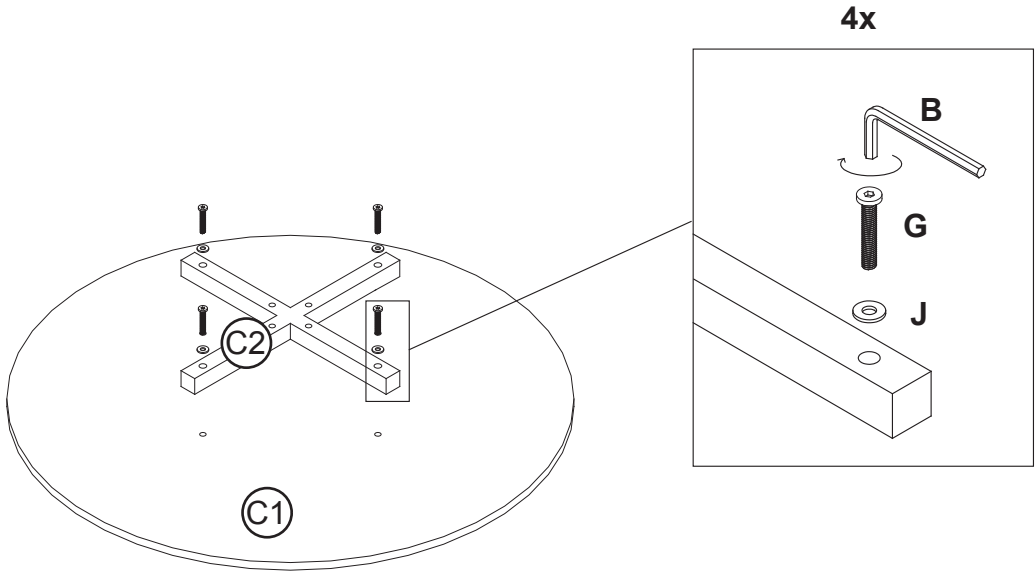
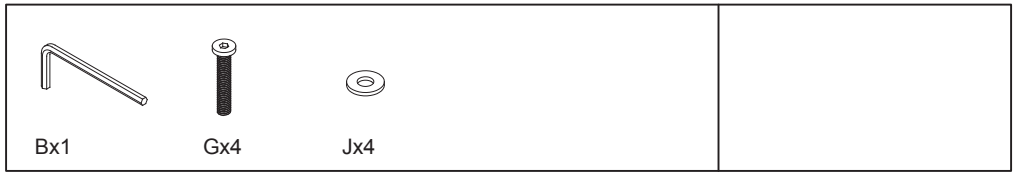

2

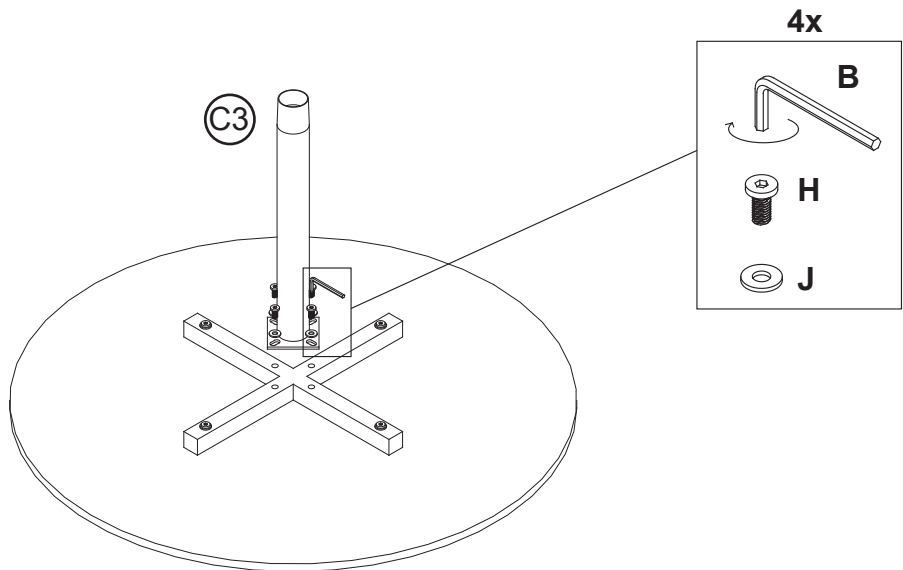

3

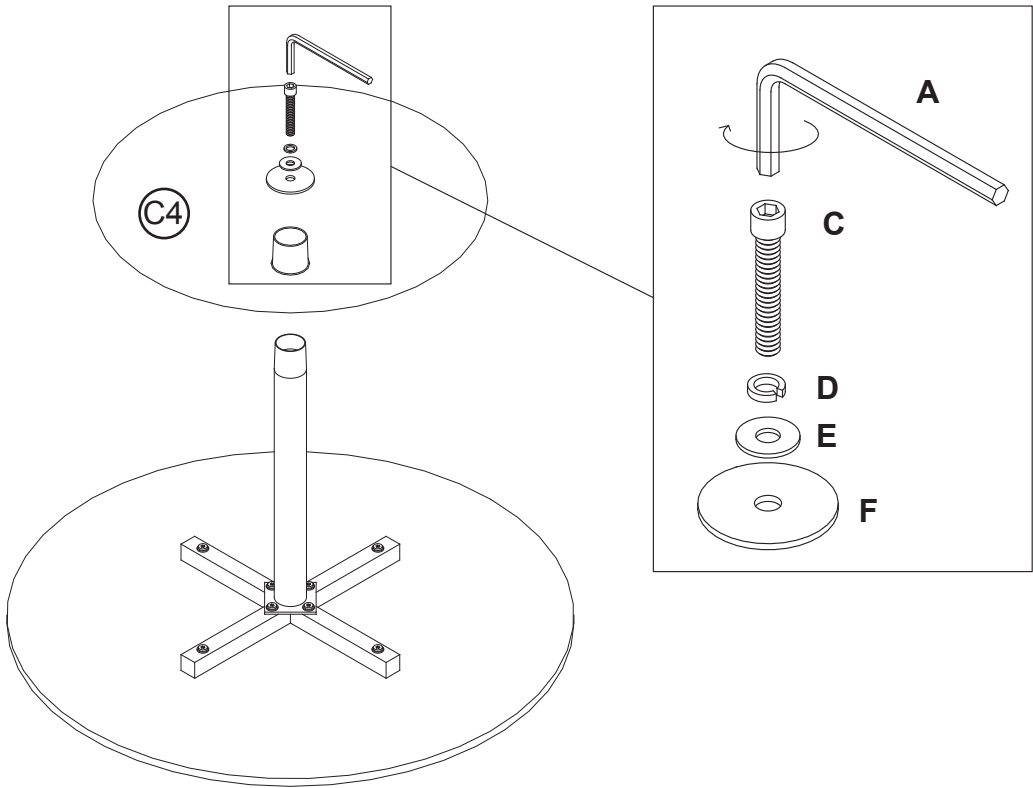
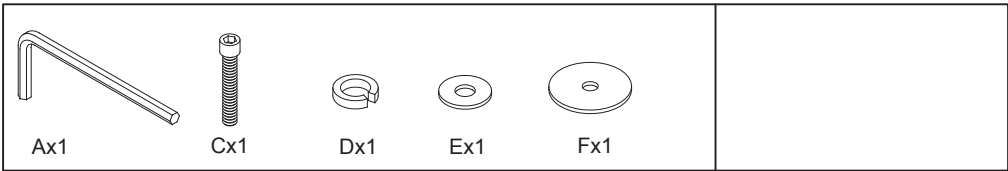

4

