

# ASSEMBLY INSTRUCTION

## SELF ASSEMBLY

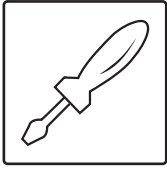

**1** Person build  
Estimated build time  
**15 min**



## CAUTION!

It is the responsibility of the persons assembling the furniture to properly install all components and hardware as specified in these instructions. Please follow strictly the order of assembly shown in these instructions.

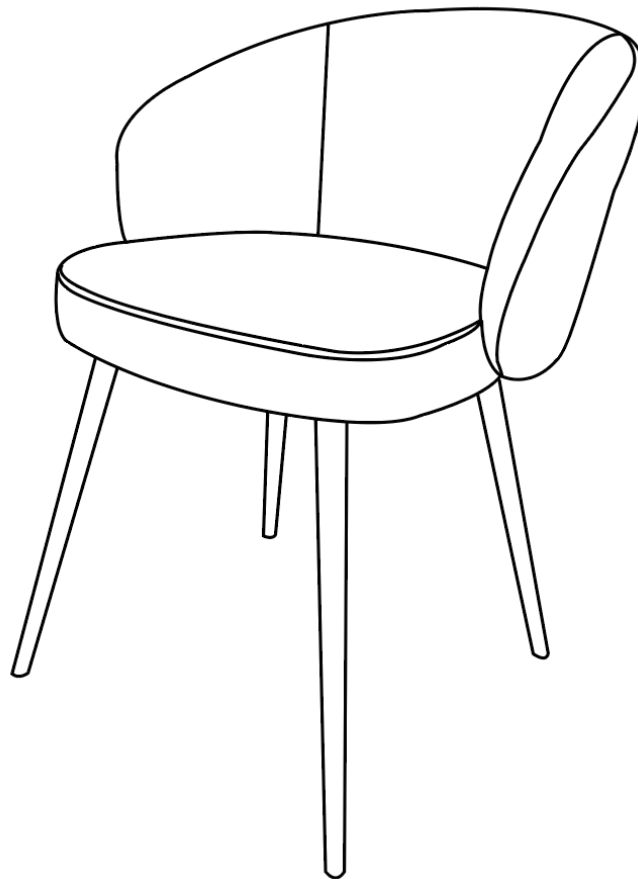

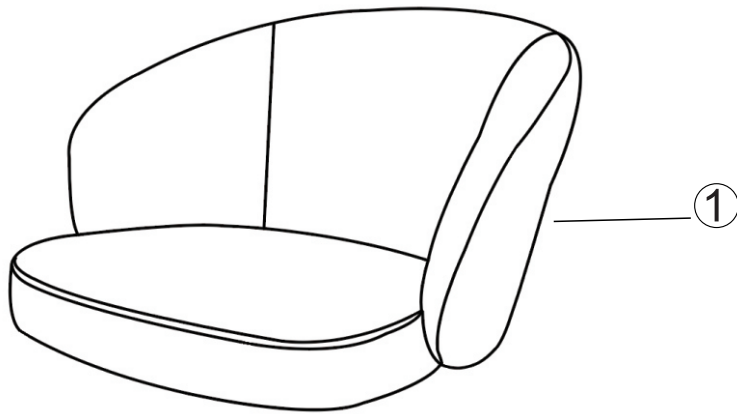

- 1× ①
- 1× ②
- 1× ③

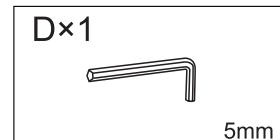
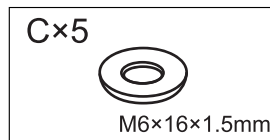
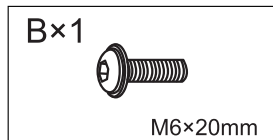
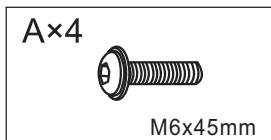
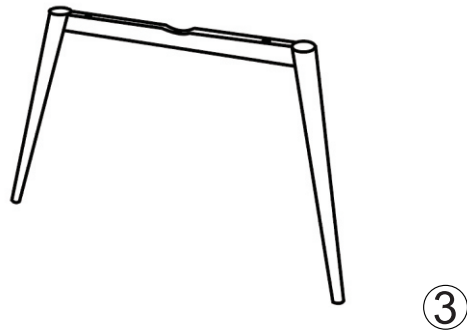
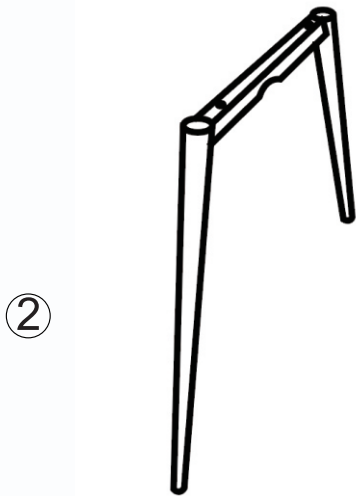

1

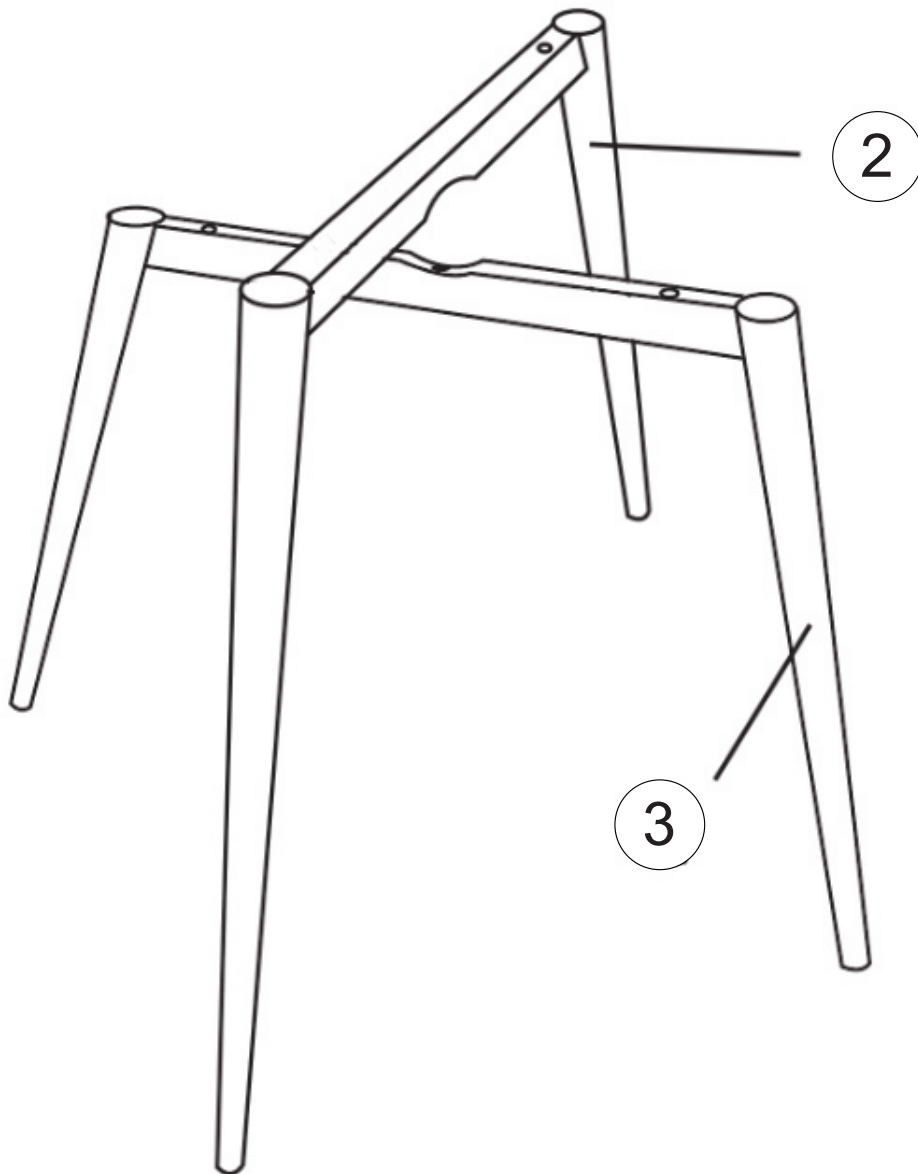
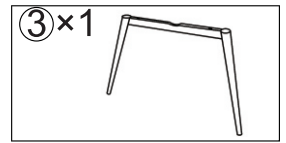
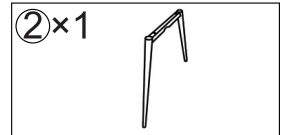

2

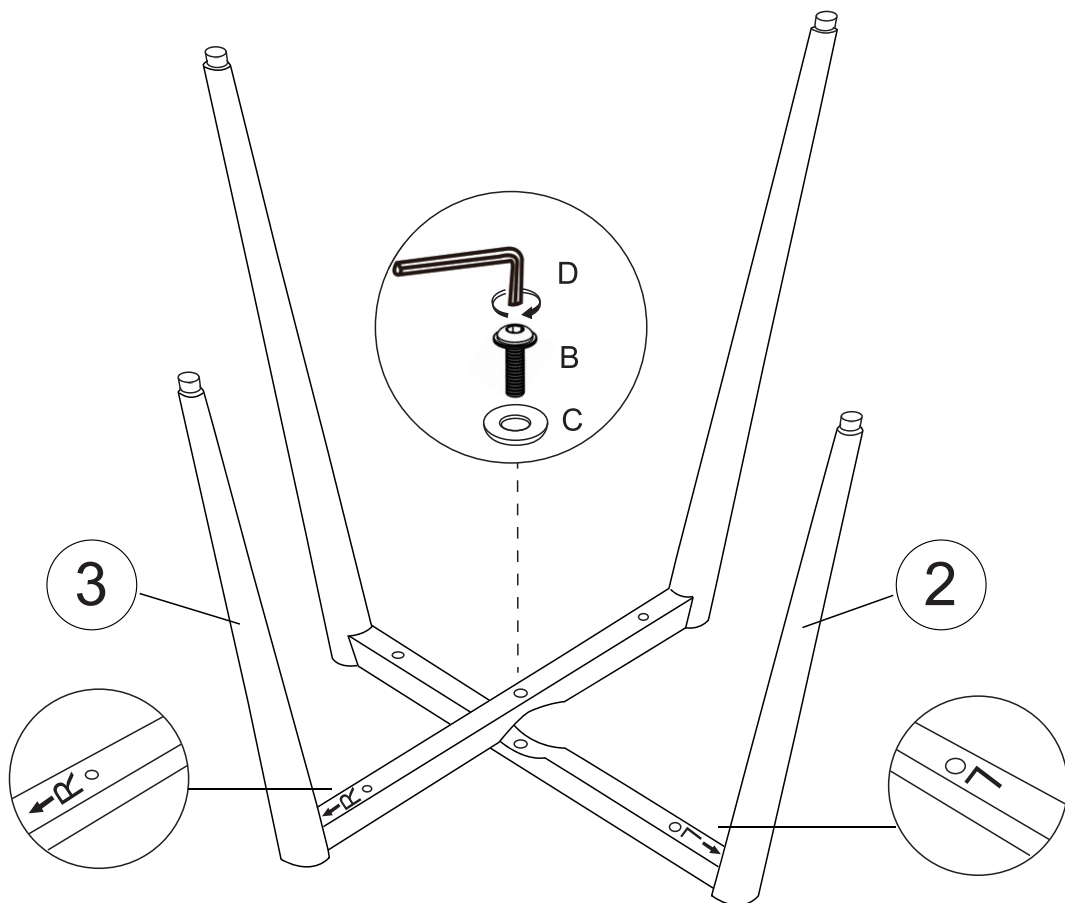
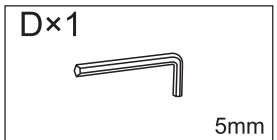
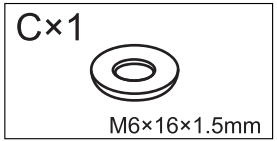
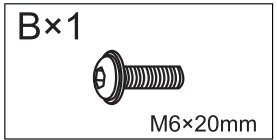

3

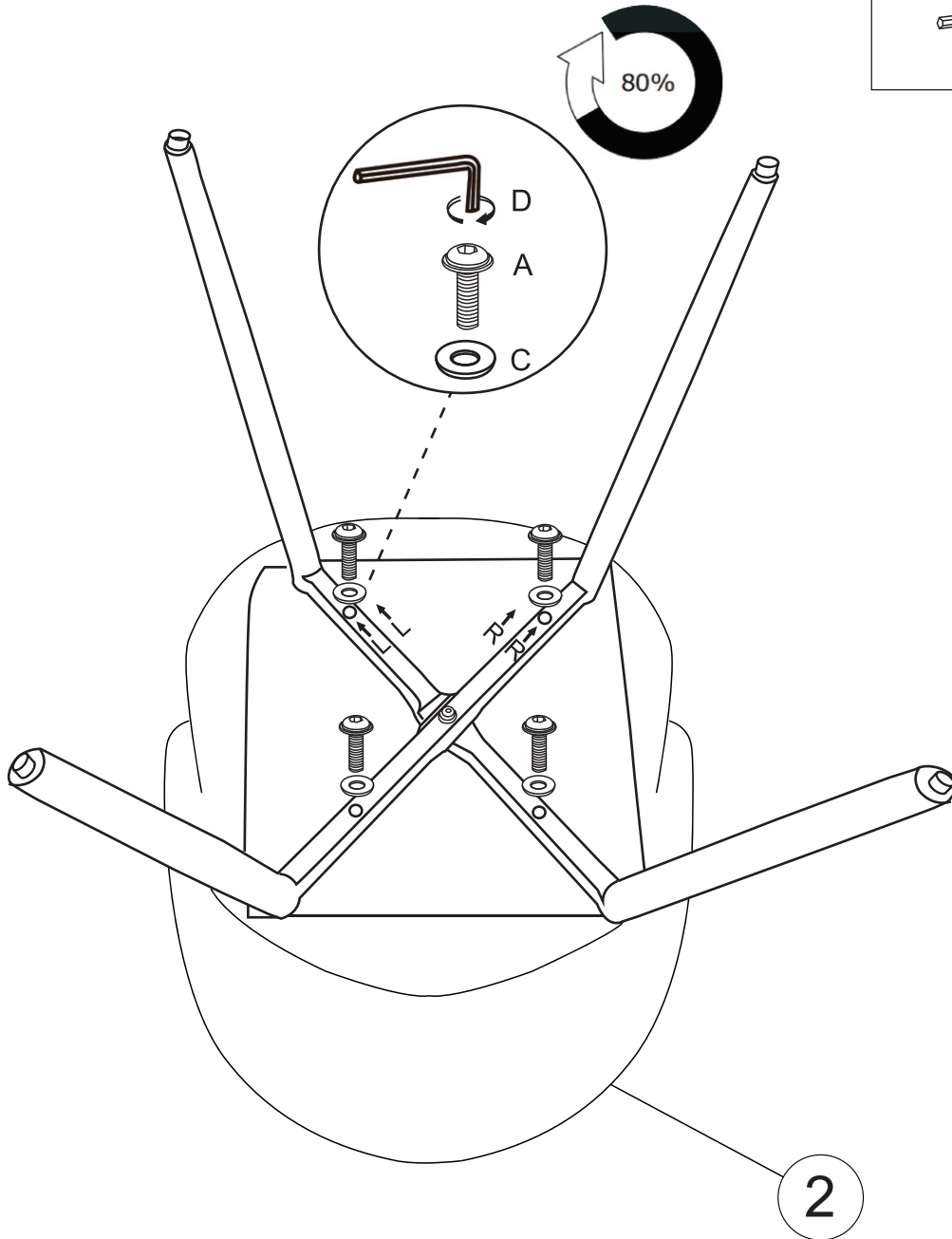
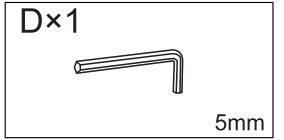
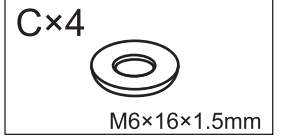
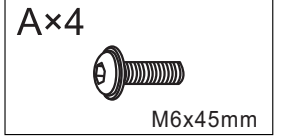

The "L" "R" marks on the leg should be in the same position as marks on seat. Wrong installation might cause the chair leg broken.

Before fully assembling all parts, make sure to tighten all screws only to 80% of their final tightness. Do not over-tighten at this stage.

4

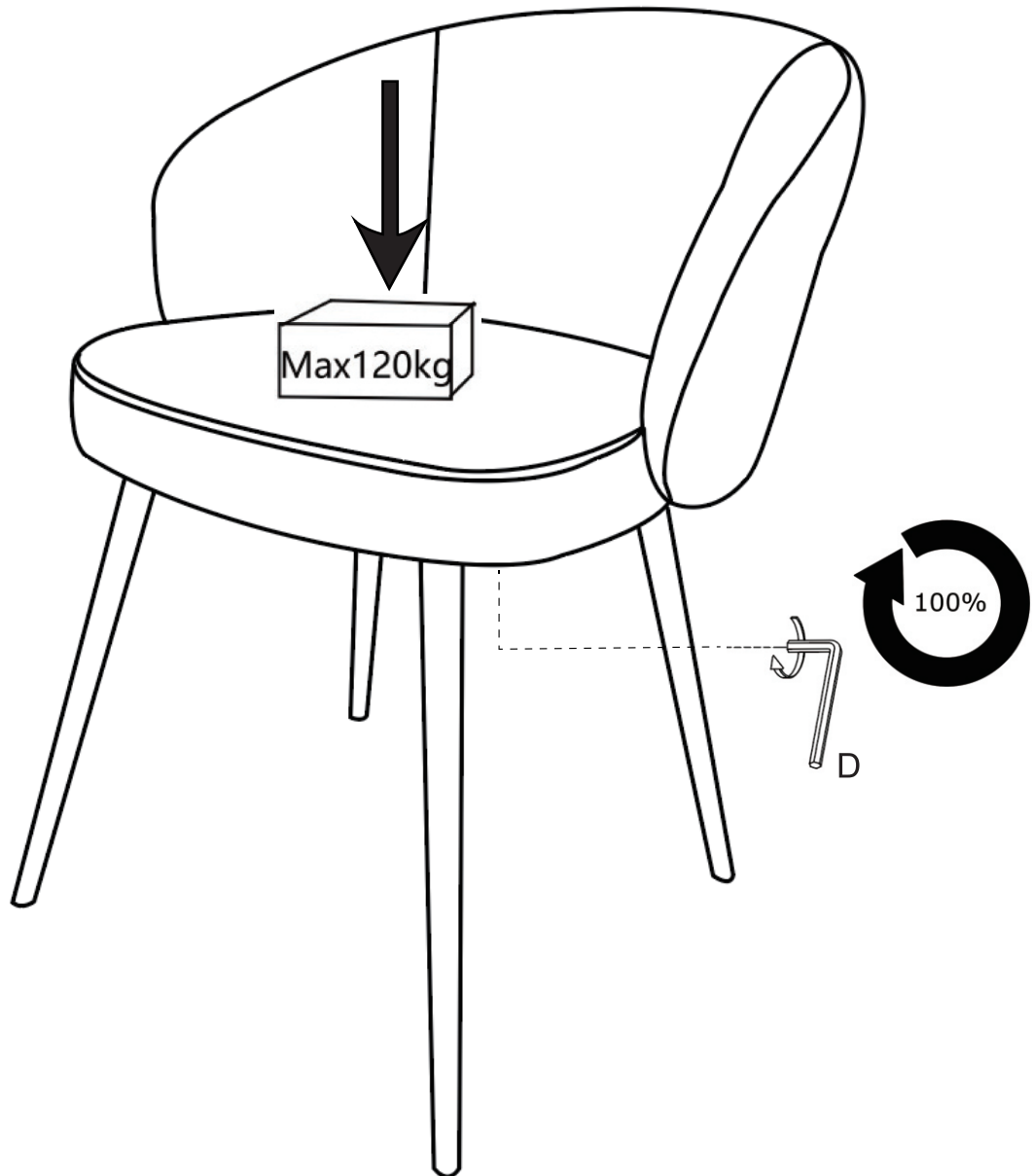

Turn the chair over and position it correctly. Adjust all legs so they rest evenly on the floor, then slowly tighten the screws. During this process, gradually tighten the screws while adjusting the legs for balance until all the screws are securely tightened.