

Hollywood LED Makeup Mirror

Before You Start

- ⚠ Please read all instructions carefully.
- ⚠ Retain instructions for future reference.
- ⚠ Separate and count all parts and hardware.
- ⚠ Read through each step carefully and follow the proper order.
- ⚠ We recommend that, where possible, all items are assembled near to the area in which they will be placed in use, to avoid moving the product unnecessarily once assembled.
- ⚠ Always place the product on a flat, steady and stable surface.
- ⚠ Keep all small parts and packaging materials for this product away from babies and children as they potentially pose a serious choking hazard.

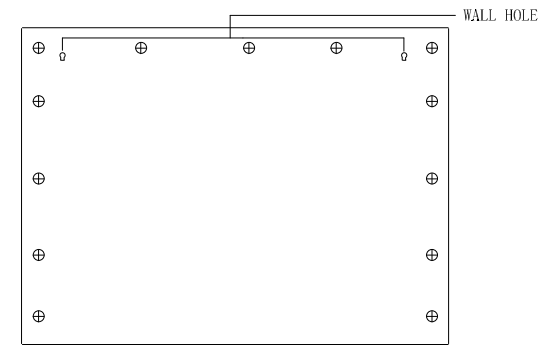
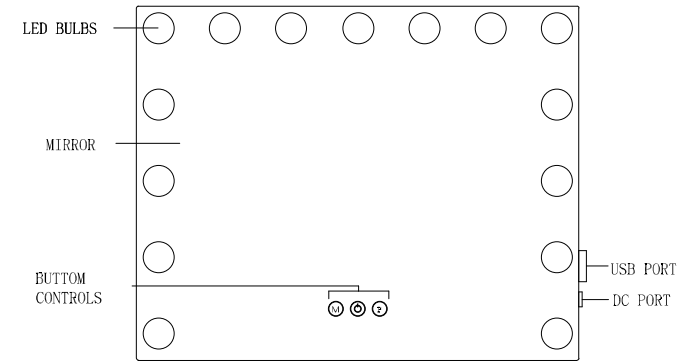

BUTTON CONTROLS

M BUTTON: Short press to change the color temperature
(warm light, nature light, cool light)
P BUTTON: Long press to do the brightness adjustment
⊕ BUTTON: Short press to turn on/off the light

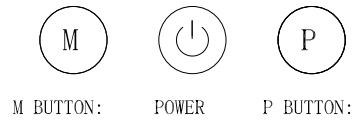

CONTAINED ITEMS

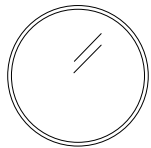

5X magnifying

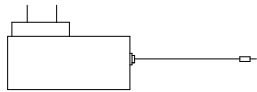

12V Power Adapter
Input 100_240V Output 12V 2A

Please use included power adapter Do not use an unsuitable power adapter, otherwise it could damage the mirror electronics

PRODUCT SIZE

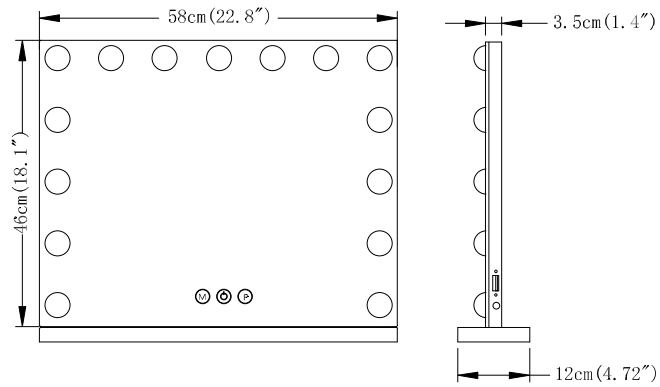

CONTAINED ITEMS

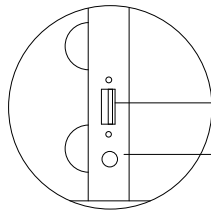

→ USB Port for charging the electronic advices, like mobile phone.

→ Connect the power to use LED Mirror lights. Disconnect the power to off LED Mirror lights.

INSTALLATION STEPS

- ① MAKE SURE THE HOLES AND THE BASE ARE ALLIGNED
- ② SCREW THE BOLTS FROM THE BOTTOM OF THE BASE TO THE MIRROR

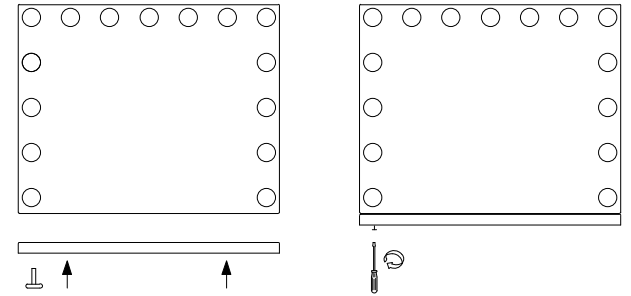

- ③ SCREW THE BOLTS FROM THE BOTTOM OF THE HOLDER TO THE BACKBOARD FIXED BRACKET

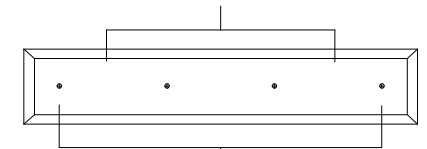

FIXED MIRROR

