



## Water Fountain Instruction Manual



MODEL: FF4054-BLACK-SOL    INCLUDE: LED LIGHTS & PUMP

2026.V2

Thank You for Purchasing FORFAR® Fountain

# Contents

- Introduction..... Page 1
- Assembly Instructions..... Page 2
- Warranty & Return Policy..... Page 3
- Electrical safety..... Page 3
- Maintenance & Care..... Page 4
- Water Pump Maintenance..... Page 4
- Troubleshooting..... Page 5
- Frequently Asked Questions (FAQ)..... Page 6

## Introduction

Your ForFar fountain is built to meet the highest standards of performance and safety.

If you require any additional assistance, please contact our support team through the help section of your point of purchase. We will be happy to assist you.



**Email: [support@forfar-group.com](mailto:support@forfar-group.com)**

**Official Website: [www.forfar-group.com](http://www.forfar-group.com)**

# ASSEMBLY INSTRUCTIONS

Components	Quantity
Fountain	1
LED Light	1 set (Pre-installed)
Solar Pump	1
Solar Panel	1

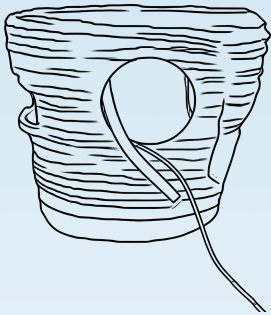
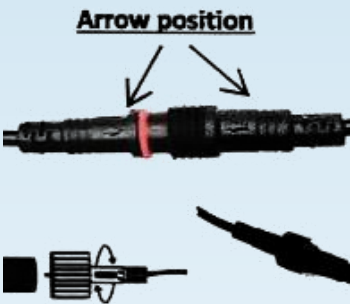
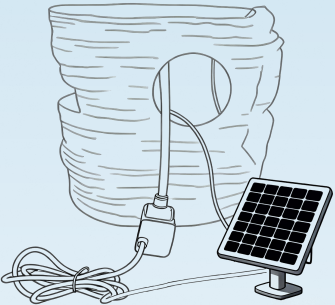
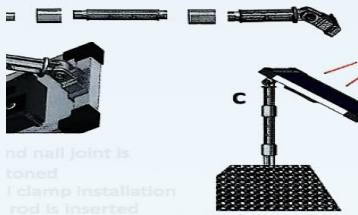
**!** Always handle components carefully during assembly.

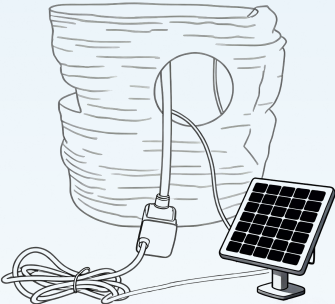
 <p>Cut any nylon ties. Gently pull out the water tubing and the internal LED wire(s) by reaching into the back opening of the fountain.</p>	 <p>Screw the plastic waterproof collars on all cable connections tightly to prevent water ingress and ensure a firm seal.</p>	 <ol style="list-style-type: none"> <li>1. Connect the pump cable to the solar panel securely, ensuring the knob is tightened.</li> <li>2. Connect the water tube to the outlet nozzle of the pump.</li> </ol>
 <p>A: Ensure the ground nail joint is tightly secured.          B: Install the floor nail clamp properly.          C: Insert the fixed rod into the surface and adjust the solar panel angle to face the sun.</p>	 <p>Pour the water into the fountain, be sure to pour an appropriate amount to avoid overflow, it's crucial to ensure the pump is completely submerged in the water.</p>	 <p>Place the pump back into the reservoir, close the cover door securely and feed the pump power cords through the designated cut-out slot at the back of the fountain to prevent entanglement or obstruction by the door.</p>

## Important:

- Check the water level every 48 hours and refill if needed, as water may decrease due to evaporation or splashing.
- When using the fountain for the first time, air may be trapped inside the pump. It can take several minutes for the air to be released before the water flows smoothly.

# WARRANTY & RETURN POLICY



## Return Policy

- **Within 30 days of purchase:** Free return shipping for qualified issues.
- **After 30 days:** Buyer is responsible for return shipping costs.
- **Non-quality related returns:** Buyer is responsible for **50% of the return shipping costs**.
- **Price protection:** If you find a lower price within 30 days of purchase, you do not need to return the product. Please contact us to receive a refund of the price difference.
- **Return process:** Please return the product using the Amazon return label or the return label provided by us.



## Warranty Terms

- 30-Day Free Return Policy.
- **1-Year Limited Warranty** covering non-artificial (non-human-caused) damage.



## Not Covered Under Warranty

- Damage due to improper maintenance, lack of water, or dry operation.
- Damage from freezing, extreme weather, or accidental damage.
- Pump failure due to clogging, burning smell, or scale/algae buildup.
- Surface discoloration, paint peeling, or damage from limescale, algae, or frost.
- Natural wear and tear.

# ELECTRICAL SAFETY



## Warning

- **Pump waterproof rating:** IPX8
- **Light cord waterproof rating:** IPX6
- **Warning:** Keep all cables and connections out of water. If exposed, tighten the knob securely.



## Caution

- **Prevent pump damage:** Always keep the fountain filled with enough water. Refill promptly to avoid long periods of **dry running**, which may cause overheating and shorten pump life.

# MAINTENANCE & CARE

## Fountain Care Guidelines

- **Winter Care:** If possible, bring the fountain indoors (e.g., garage or shed).
- If freezing conditions are expected, **drain all water completely** to prevent cracking or damage.

## Fountain Cleaning Tips

To empty the fountain for cleaning or winter storage:

- **Small fountains:** Invert and allow water to pour away naturally.
- **Large fountains:** Use a large sponge or siphon pipe to remove water.
- **Always switch off power** before cleaning or performing maintenance.
- **Note:** Water stains may be present. This does **not** indicate that the fountain is second-hand. Testing water may not dry completely before repacking, which can leave marks when opening the package.

# WATER PUMP MAINTENANCE

## How to Clean the Water Pump

- **Pump:** If the pump loses power or stops working, check the filter for sediment, scale, or dirt. Remove the pump and impeller covers, then rinse all parts with clean water.
- **Solar Panel:** Clean the panel periodically with a soft cloth. Regular cleaning is recommended to maintain optimum sunlight conversion to direct current.

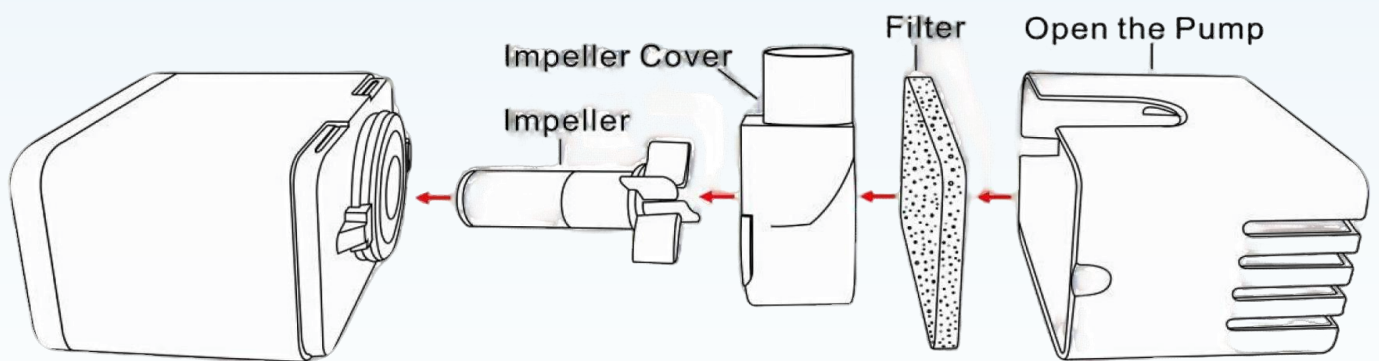

# TROUBLE SHOOTING

Issue	Possible Cause	Solution
<b>Solar panel Short working hours /No work at night</b>	There is sunlight throughout the day until sunset, but the solar panels receive limited exposure as the sunlight becomes blocked. After 2 p.m., the battery must supply power, and by nightfall the battery is often low or fully depleted.	<ul style="list-style-type: none"> <li>• Keep the pump fully submerged (at least 2 in / 5 cm).               <ul style="list-style-type: none"> <li>• Clean the impeller and intake to prevent blockage.</li> </ul> </li> <li>• Check all connections are secure.</li> <li>• Charge the solar panel separately at a 45° angle in direct sunlight, then reconnect to the fountain.</li> </ul>
<b>Low water flow</b>	<ul style="list-style-type: none"> <li>• Water level too low.</li> <li>• Pump or tube blocked.</li> <li>• Flow control valve set too low.</li> </ul>	<ul style="list-style-type: none"> <li>• Top up the water.</li> <li>• Clean the pump and tubing.</li> <li>• Adjust the flow control valve.</li> </ul>
<b>LED Lights not working</b>	<p><b>For solar-powered models, lights turn on only at night</b></p> <ul style="list-style-type: none"> <li>• Check that the LED wire connections inside the fountain are tight and secure.</li> </ul>	<ul style="list-style-type: none"> <li>• If only some LEDs are not working, they may be faulty — please contact support.               <ul style="list-style-type: none"> <li>• If the lights do not turn on at night, ensure no nearby light sources are affecting the solar panel and adjust its angle to prevent interference.</li> </ul> </li> </ul>
<b>Water Leakage</b>	<ul style="list-style-type: none"> <li>• Fountain not placed on a level surface.</li> <li>• Basin overfilled.</li> <li>• Natural evaporation.</li> <li>• Leakage from a seam.</li> </ul>	<ul style="list-style-type: none"> <li>• Place the fountain on a level surface.</li> <li>• Avoid overfilling the basin.               <ul style="list-style-type: none"> <li>• Top up water regularly to compensate for evaporation.</li> </ul> </li> <li>• If leaking from a seam, apply waterproof sealant (may qualify for partial compensation – <b>contact us</b>).</li> </ul>
<b>Flickering Lights</b>	<ul style="list-style-type: none"> <li>• Often caused by algae or mineral scale on LED contacts. Clean pump and fountain.</li> </ul>	<ul style="list-style-type: none"> <li>• Clean pump and fountain.</li> </ul>

# Frequently Asked Questions (FAQ)

## Q1: How much water should I add to the outdoor fountain?

**A:** Ensure the water level is **above the pump** so it can operate smoothly, but **do not overflow**. A removable panel at the bottom indicates the safe maximum level.

---

## Q2: How often should I change the water?

**A:** It is recommended to change the water every 3–5 days, or more frequently in hot weather, to keep the water fresh and prevent algae growth.

---

## Q3: Are the power cords for the pump and lights completely waterproof? Can I place them inside the product?

**A:** Yes. The cords are waterproof. Be sure to **tighten the waterproof connectors**. If you are unsure, please **contact us**.

---

## Q4: If I need phone support, what should I do?

**A:** After-sales support is primarily provided through **Amazon**. Go to **“Your Orders”** → find this item → click **“Get help with order”**. We can arrange further assistance from there if needed.

---

## Q5: What should I do if the water flow becomes weak?

**A:** Make sure the pump is **fully submerged** and that the water inlet is **free of debris**. Regularly clean the pump to maintain optimal performance.

---

## Q6: How do I clean the fountain and pump?

**A:** Turn off and unplug the unit. Rinse the fountain and pump with **clean water** and gently scrub away debris. Avoid harsh chemicals.

---

## Q7: Can I repaint or touch up the resin surface if it gets scratched?

**A:** Yes. Use **outdoor-grade acrylic paint**. Ensure the surface is clean and dry before painting.

---

## Q8: Is the resin material durable for outdoor use?

**A:** Yes. The fountain is made of **high-quality resin**, designed to be **durable, weather-resistant, and suitable for outdoor environments**.

---

## Q9: Can I use distilled or tap water?

**A:** Both are acceptable, but **distilled water is recommended** to minimize mineral buildup and extend pump life.

---

## Q10: How should I clean the resin surface?

**A:** Use a **soft cloth or sponge with mild soap and water**. Avoid abrasive brushes or harsh cleaners to prevent scratching.

